

SIRENA



#morethanbrightideas

Dispositivi di segnalazione
acustica e luminosa

Visual and acoustic
signaling devices

Dispositifs de signalisation
visuelle et acoustique



Catalogo Generale

General Catalogue

Catalogue Général

L'INTERO MONDO SIRENA IN UN UNICO SUPPORTO.

I prodotti e le soluzioni, presentate nelle pagine seguenti, conferiscono sicurezza e funzionalità in numerosi processi e applicazioni. La nostra mission, da oltre quarant'anni, è quella di mettere a disposizione dei nostri clienti prodotti con performance di alto livello, che rispondano alle loro esigenze nel campo della segnalazione industriale e civile, dell'automazione e dell'antincendio.

Il know-how e l'esperienza Sirena al servizio dei professionisti.



THE EXTENSIVE SIRENA'S CHOICE AT A GLANCE.

The products and solutions on subsequent pages guarantee safety and functionality in numerous processes and applications. Our mission for more than 40 years is to provide our customers with high-end products that fulfill their requirements in the fields of industrial and civil signaling, automation and Fire Alarm.

Sirena's know-how and experience for professional needs.



L'UNIVERS SIRENA A PORTEE DE MAIN DANS UN SUPPORT UNIQUE.

Les produits et solutions présentés dans les pages suivantes garantissent la sûreté et la fonctionnalité de nombreuses applications. Notre mission depuis plus de 40 ans est de fournir à nos clients des produits de haute qualité répondant à leurs exigences en matière de signalisation civile et industrielle, d'automatisation et de système d'alarme incendie.

L'expérience et le savoir-faire Sirena au service des professionnels.



SIRENA

ELECTRA

6 - 91



MLINE

92 - 123



AUTOMAX

124 - 169



FOUR

170 - 183

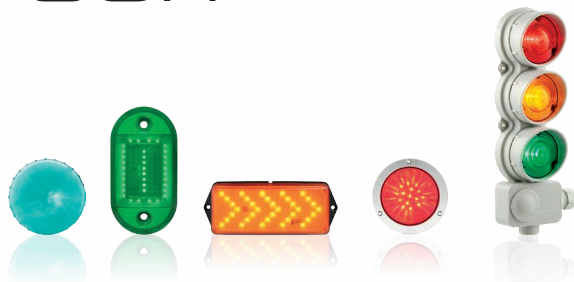

WORKPLUS 184 - 207



EXPRO

208 - 239



ESCAPE

240 - 289



ICARO





























































290 - 327



CODICI / CODES

328 - 352

LEGENDA / LEGEND / LEGENDE

	MATERIALE: ALLUMINIO MATERIAL: ALUMINIUM MATERIEL: ALUMINIUM		SORGENTE LUMINOSA: ALOGENA LUMINOUS SOURCE: HALOGEN SOURCE LUMINEUSE: HALOGENE		NUMERO DI TONI NUMBER OF TONES NOMBRE DE SONS
	MATERIALE: VETRO MATERIAL: GLASS MATERIEL: VERRE		SORGENTE LUMINOSA: A FILAMENTO LUMINOUS SOURCE: INCANDESCENT SOURCE LUMINEUSE: INCANDESCENCE		LIVELLI DI ALLARME ALARM LEVELS NIVEAUX D'ALARME
	MATERIALE: POLICARBONATO/ABS MATERIAL: POLYCARBONATE/ABS MATERIEL: POLYCARBONATE/ABS		SORGENTE LUMINOSA: A FILAMENTO LUMINOUS SOURCE: INCANDESCENT SOURCE LUMINEUSE: INCANDESCENCE		USO CON PLC USE WITH PLC COMPATIBLE AVEC API
	MATERIALE: POLICARBONATO MATERIAL: POLYCARBONATE MATERIEL: POLYCARBONATE		SORGENTE LUMINOSA: A FILAMENTO LUMINOUS SOURCE: INCANDESCENT SOURCE LUMINEUSE: INCANDESCENCE		PRESSACAVO CABLE GLAND PRESSE-ETOUPE
	MATERIALE: ABS MATERIAL: ABS MATERIEL: ABS		FREQUENZA FREQUENCY FREQUENCE		VITE M10 M10 SCREW VIS M10
	MATERIALE: POLIAMMIDE (NYLON) MATERIAL: POLYAMIDE (NYLON) MATERIEL: POLYAMIDE (NYLON)		TEMPERATURA DI FUNZIONAMENTO MIN. e MAX. OPERATING TEMPERATURE MIN. and MAX. TEMPERATURE DE FONCTIONNEMENT MIN. et MAX.		TIPO FILETTATURA TYPE OF THREAD TYPE DE FILETAGE
	MATERIALE: ACCIAIO MATERIAL: STEEL MATERIEL: ACIER		GRADO IP IP RATING DEGRE IP		AUTONOMIA BATTERIA BATTERY AUTONOMY AUTONOMIE BATTERIE
	MATERIALE: ACCIAIO INOX MATERIAL: STAINLESS STEEL MATERIEL: ACIER INOXYDABLE		SERVIZIO CONTINUO CONTINUOUS OPERATION FONCTIONNEMENT CONTINU		TIPOLOGIA DI LENTE LENS TYPE TYPE DE LENS
	MATERIALE: METACRILATO MATERIAL: ACRYLIC MATERIEL: METHACRYLATE		CLASSE II DI ISOLAMENTO INSULATION CLASS II CLASSE II D'ISOLATION		VERNICIATURA PAINTING PEINTURE
	MATERIALE: POLIURETANO MATERIAL: POLYURETHANE MATERIEL: POLYURETHANE		AUTOESTINGUENTE SELF-EXTINGUISHING AUTOEXTINGUIBLE		NUMERO DI BATTERIE NUMBER OF BATTERIES NOMBRE DE BATTERIES
	MATERIALE: POLIPROPILENE MATERIAL: POLYPROPYLENE MATERIEL: POLYPROPYLENE		DURATA SERVIZIO SERVICE LIFE DUREE DU FONCTIONNEMENT		DURATA DELLE BATTERIE BATTERY LIFETIME DUREE DE VIE DES PILES
	MATERIALE: PVC MATERIAL: PVC MATERIEL: PVC		UTILIZZO GRAVOSO HEAVY DUTY USAGE INTENSIF		VALVOVA in GORE-TEX® GORE-TEX® VALVE VALVE en GORE-TEX®
	MATERIALE: POLIESTERE RINFORZATO FIBRA DI VETRO MATERIAL: GLASS FIBER REINFORCED POLYMER MATERIEL: POLYMERE RENFORCE FIBRE DE VERRE		RESISTENTE AI RAGGI UV UV RAY RESISTANT RESISTANT AUX RAYONS UV		GRU CRANES GRUES
	MATERIALE: ELASTOMERO TERMOPLASTICO VULCANIZZATO MATERIAL: THERMOPLASTIC ELASTOMER VULCANIZATE MATERIEL: ELASTOMERE THERMOPLASTIQUE VULCANISE		DIAMETRO MODULO MODULE DIAMETER DIAMETRE DE L'ELEMENT		TRALICCI PYLONS PYLONES
	MATERIALE: MONOMERO ETILENE-PROPYLENE DIENE (GOMMA) MATERIAL: ETHYLENE PROPYLENE DIENE MONOMER (RUBBER) MATERIEL: ETHYLENE PROPYLENE DIENE (CAOUTCHOU)		PESO WEIGHT POIDS		STRUTTURE INFRASTRUCTURES INFRASTRUCTURES
	MATERIALE: VETRO BOROSILICATO MATERIAL: BOROSILICATE GLASS MATERIEL: VERRE BOROSILICATE		CANDELE DI PICCO - MAX.* PEAK CANDELAS - MAX.* CANDELAS DE PIC - MAX.*		TURBINE EOLICHE WIND TURBINES EOLIENNES
	SORGENTE LUMINOSA: LED LUMINOUS SOURCE: LED SOURCE LUMINEUSE: LED		LUMEN LUMEN LUMEN		EDIFICI BUILDINGS BÂTIMENTS
	SORGENTE LUMINOSA: LED SMD LUMINOUS SOURCE: SMD LED SOURCE LUMINEUSE: LED SMD		ASSORBIMENTO DI CORRENTE - MAX. CURRENT CONSUMPTION - MAX. CONSOMMATION DE COURANT - MAX.		
	SORGENTE LUMINOSA: LED SUPER BRIGHT LUMINOUS SOURCE: SUPER BRIGHT LED SOURCE LUMINEUSE: LED SUPER BRIGHT		POTENZA - MAX. POWER - MAX. PUISSANCE - MAX.		
	SORGENTE LUMINOSA: XENON LUMINOUS SOURCE: XENON SOURCE LUMINEUSE: XENON		LAMPI PER MINUTO FLASHES PER MINUTE ECLATS PAR MINUTE		
	SORGENTE LUMINOSA: ALOGENA LUMINOUS SOURCE: HALOGEN SOURCE LUMINEUSE: HALOGENE		CICLI PER MINUTO CYCLES PER MINUTE CLIGNOTEMENTS PAR MINUTE		
			GIRI PER MINUTO ROTATIONS PER MINUTE TOURS PAR MINUTE		
			POTENZA SONORA SOUND OUTPUT PUISSANCE SONORE		

CE CERTIFICAZIONE CE: EN60598-1 - EN61000-6-3 - EN61000-6-2
CE CERTIFICATION: EN60598-1 - EN61000-6-3 - EN61000-6-2
CERTIFICATION CE: EN60598-1 - EN61000-6-3 - EN61000-6-2

UL CERTIFICAZIONE UL: Per gli Stati Uniti e il Canada
UL CERTIFICATION: For Us And Canada
CERTIFICATION UL: Pour les Etats-Unis et Canada

ICAO CERTIFICAZIONE ICAO: International Civil Aviation Administration appendix 14, Chapter 6

ICAO CERTIFICATION: International Civil Aviation Administration appendix 14, Chapter 6

CERTIFICATION OACI: Organisation de l'Aviation Civile Internationale - annexe 14, Chapitre 6

CERTIFICAZIONE FAA: Federal Aviation Administration - USA
FAA CERTIFICATION: Federal Aviation Administration - USA
CERTIFICATION FAA: Federal Aviation Administration - USA

CERTIFICAZIONE STAC: Certificazione STAC Francia per prodotti ICAO

STAC CERTIFICATION: STAC approval in France for ICAO products

CERTIFICATION STAC: Certification STAC France pour produits OACI

OMOLOGAZIONE: ECE R65 o ECE R23
APPROVAL: ECE R65 or ECE R23
HOMOLOGATION: ECE R65 ou ECE R23

OMOLOGAZIONE: EMC R10
APPROVAL: EMC R10
HOMOLOGATION: EMC R10

OMOLOGAZIONE: EMC 2006/28/CE
APPROVAL: EMC 2006/28/CE
HOMOLOGATION: EMC 2006/28/CE

CERTIFICAZIONE EAC
EAC CERTIFICATION
CERTIFICATION EAC

DIRETTIVA EN54: rilevamento incendio e sistemi di allarme antincendio
EN54 DIRECTIVE: fire detection and fire alarm system
DIRECTIVE EN54: systèmes d'alarmes incendies

CERTIFICAZIONE TÜV SÜD
TÜV SÜD CERTIFICATION
CERTIFICATION TÜV SÜD

CERTIFICAZIONE GOST
GOST CERTIFICATION
CERTIFICATION GOST

MARCATURA ATEX
ATEX MARK
MARQUE ATEX

CIMINIERE
CHIMNEYS
CHEMINEES

TORRI PIEZOMETRICHE
WATER TANKS
CHÂTEAU D'EAU

AEROPORTI
AIRPORTS
AEROPORTS

VEICOLI PRIORITARI
PRIORITY VEHICLES
VEHICULES PRIORITAIRES

ELIPORTI
HELIPADS
HELIPORTS



VEICOLI TERRESTRI AEROPORTUALI
GROUND OPERATION VEHICLES
VEHICULES DE SERVICE AU SOL

EN 60529 "Gradi di protezione degli involucri / International Protection Levels of Enclosures / Indice de protection"	
1ª CIFRA / 1 st DIGIT / 1 ^{er} CHIFFRE	2ª CIFRA / 2 nd DIGIT / 2 ^e CHIFFRE
<p>Protezione contro corpi solidi estranei / Protection against accidental contact and penetration by solid foreign bodies / Protection contre tout contact accidentel et pénétration de corps étrangers solides</p>	<p>Protezione contro l'acqua / Protection against penetration of liquids / Protection contre les corps liquides</p>
<p>IPOX Non protetto / No particular protection / Aucune protection</p>	<p>IPX0 Non protetto / No particular protection / Aucune protection</p>
<p>IP1X Protetto contro corpi solidi estranei superiori a 50 mm (es. contatto involontario della mano) / Protection against solid bodies over 50 mm and against contacts by large surfaces of the human body (e.g. the hands) / Protégé contre les corps solides supérieures à 50 mm (ex. contact involontaires de la main)</p>	<p>IPX1 Protetto contro la caduta verticale di gocce d'acqua (condensa) / Protection against the vertical fall of drops of water (e.g. condensation) / Protégé contre les chutes verticales de gouttes d'eau (ex. condensation)</p>
<p>IP2X Protetto contro corpi solidi estranei superiori a 12,5 mm (es. dito della mano) / Protection against solid bodies over 12,5 mm and against finger contact / Protégé contre les corps solides supérieurs à 12,5 mm (ex. doigt de la main)</p>	<p>IPX2 Protetto contro la caduta verticale di gocce d'acqua con un'inclinazione fino a 15° / Protection against the vertical fall of drops of water with a maximum incline of 15° / Protégé contre les chutes d'eau jusqu'à 15° de la verticale</p>
<p>IP3X Protetto contro corpi solidi estranei superiori a 2,5 mm (es. utensili e viti) / Protection against solid bodies over 2,5 mm (e.g. tools, wires) / Protégé contre les corps solides supérieurs à 2,5 mm (ex. outils, vis)</p>	<p>IPX3 Protetto contro la caduta verticale di pioggia con un'inclinazione fino a 60° / Protection against the vertical fall of drops of water with a maximum incline of 60° / Protégé contre l'eau en pluie jusqu'à 60° de la verticale</p>
<p>IP4X Protetto contro corpi solidi estranei superiori a 1 mm (es. utensili e cavi sottili) / Protection against penetration of solid bodies with a diameter or thickness over 1 mm (e.g. wires) / Protégé contre les corps solides supérieurs à 1 mm (ex. outils fins, petits fils)</p>	<p>IPX4 Protetto contro gli spruzzi d'acqua da tutte le direzioni / Protection against splashes of water from all directions / Protégé contre les projections d'eau de toutes directions</p>
<p>IP5X Protetto contro la polvere (nessun deposito apprezzabile) / Dust penetration is not fully excluded, but the quantity that penetrates causes no damaging effects / Protégé contre les poussières (pas de dépôt nuisible)</p>	<p>IPX5 Totalmente protetto contro i getti d'acqua potenti / Protection against waves of water or powerful jets / Totalmente protégé contre les forts jets d'eau de toutes directions à la lance</p>
<p>IP6X Totalmente protetto contro la polvere / No dust penetration is permitted / Totalment protégé contre les poussières</p>	<p>IPX7 Protetto contro gli effetti dell'immersione / Protection against the effects of immersion / Protégé contre les effets de l'immersion</p>
	<p>IPX8 Protetto contro gli effetti dell'immersione continua in condizioni specificate / Protection against the effects of prolonged immersion under pressure / Protégé contre les effets de l'immersion prolongée dans des conditions spécifiées</p>

* Nelle pagine che seguono, riportiamo per ogni segnalatore luminoso il valore massimo in Candele di picco Cd(p), misurato con cupola neutra (salvo dove diversamente indicato) e nella posizione di massima resa.

In the following pages we indicate, for each luminous device, the maximum Peak Candela value Cd(p), measured with clear dome (unless otherwise stated) and in the position of its maximum luminous efficacy.

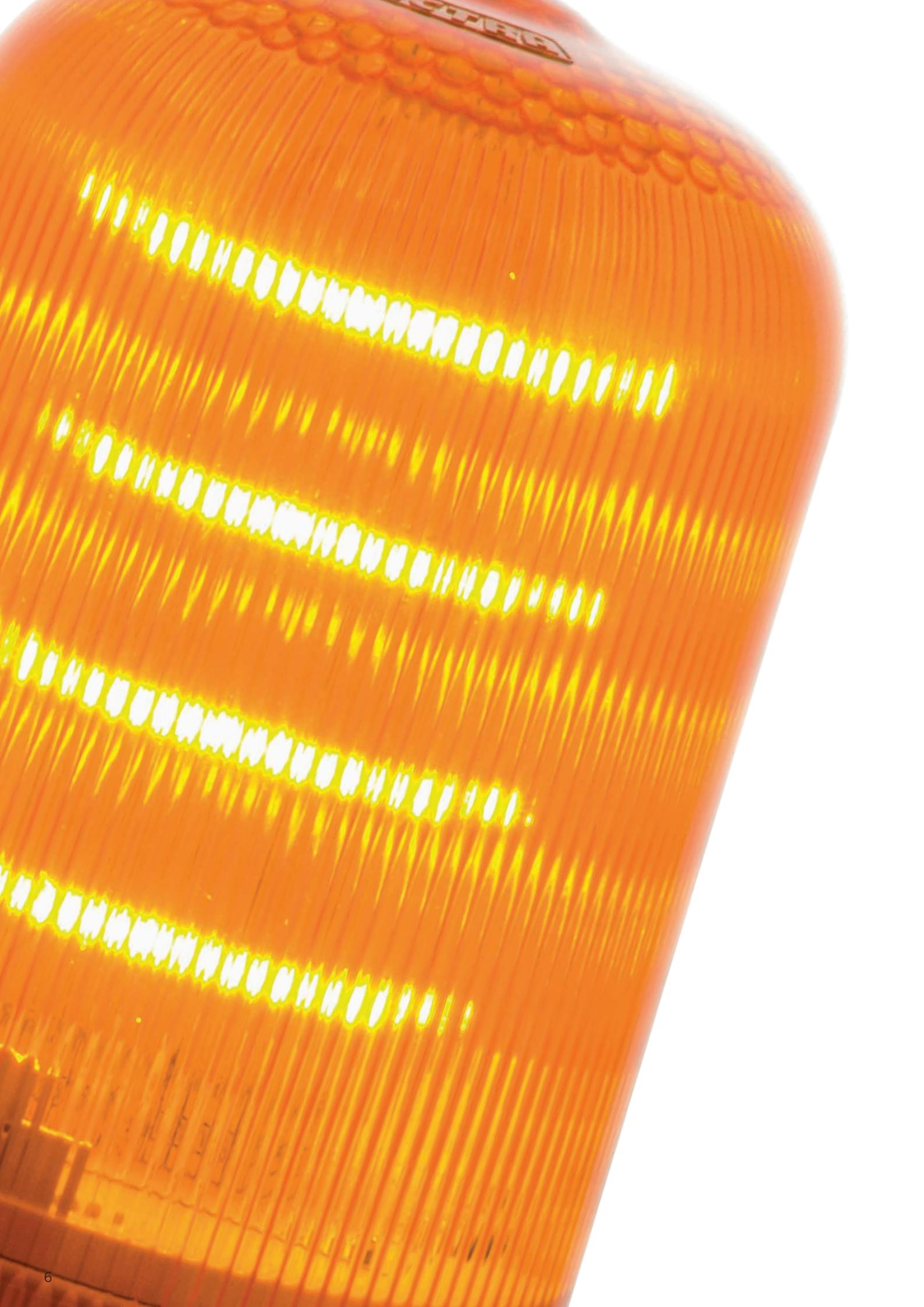
Dans les pages suivantes nous indiquons, pour chaque avertisseur lumineux, la valeur maximale de Candela de pic Cd(p), mesurée avec dôme incolore (sauf indication contraire) et dans sa position de rendement maximal.



ELECTRA

Segnalazione industriale dal 1974
Industrial signaling since 1974
Signalisation industrielle depuis 1974



SIRENA

10 Tradizione e innovazione Tradition & innovation Tradition et innovation

12 Sirene elettromeccaniche Electro-mechanical sirens Sirènes électromécaniques

- 14 CELERE
- 15 CELEREST
- 16 CELERSON
- 17 MICRO W10



18 Sirene elettroniche Electronic sirens Sirènes électroniques

- 20 SE 4 MS5/PLC
- 21 SE 10 MS5
- 22 SE 12 MS5
- 23 SE 12 MS32
- 24 SE 25 MS5
- 25 SEP LED MS32



26 Avvisatori acustici Industrial horns Avertisseurs acoustiques

- 28 BABYSAI LED
- 29 MICROSAI
- 30 SAI
- 31 SEM - SEM PLUS
- 32 SEM LED
- 33 SIAD



34 Luci bordo macchina Luminous devices on machinery Feux de signalisation machine

- 36 MICROLAMP
- 38 CTL 600
- 39 CTL 900
- 40 CTL 1200
- 42 OVOLUX RGB
- 43 OVOLUX
- 45 ACCESSORI OVOLUX
OVOLUX ACCESSORIES
ACCESSOIRES OVOLUX



46 Luci industriali Industrial beacons Feux industriels

- 48 ROTALLARM S LED
- 49 ROTALLARM HD LED
- 50 ROTALLARM WP LED
- 51 ROTALLARM S
- 53 ROTALLARM HD
- 55 MINIFLASH LED
- 56 MINIFLASH
- 58 MAXIFLASH LED
- 59 MAXIFLASH
- 60 TYPE 200
- 61 FAROLAMP LED
- 62 FAROLAMP X
- 63 STR



66 Segnalatori quadristica Signaling devices for control panels Avertisseurs sonores et lumineux pour tableaux de commande

- 68 P50 A
- 69 P40 A
- 70 P50 A LED
- 71 P40 A LED
- 72 BIMF LED
- 73 BIP 92
- 74 BEBIP
- 75 BIP 84
- 76 BIP 81
- 77 P50 S
- 78 P40 S
- 79 P50 RGB
- 80 P50 RGA
- 81 P40 RGA
- 82 FWL 3.0
- 83 LD 12 LINEAR



84 Lampade ricambio Spare bulbs Ampoules de rechange



85 Lampade a LED LED bulbs Ampoules à LED



88 Normative e Specifiche Tecniche Normatives and Technical Specifications Normes et Spécifications Techniques

TRADIZIONE E INNOVAZIONE

Da 40 anni in Sirena progettiamo, sviluppiamo e produciamo i migliori dispositivi per la segnalazione acustica e luminosa disponibili sul mercato.

Tradizione, passione e innovazione sono i principi fondamentali della nostra lunga storia, gli stessi principi che ci spingono ad andare avanti, continuando a fare quello che sappiamo fare meglio: dettare gli standard della segnalazione.

Accogliamo con orgoglio e responsabilità, il ruolo di leader che il mercato ci ha assegnato e attualmente raccogliamo la fiducia di oltre 200 clienti in 70 paesi nel mondo, collaborando con prestigiosi marchi di riferimento nel settore elettrotecnico.

Ci prepariamo ad affrontare le sfide del futuro con gli stessi principi che ci hanno portato fino a qui oggi.

La continua ricerca e lo sviluppo di nuovi modelli consente di fornire soluzioni aggiornate in termini di qualità, performance ed efficienza economica. Ciò permette, grazie a un centro R&D all'avanguardia, di sviluppare internamente gamme di prodotti che soddisfano ogni tipo di esigenza, facendo sì che Sirena sia ovunque sinonimo di sicurezza nella segnalazione.

Con **ELECTRA** Sirena propone **dispositivi acustici e ottici destinati principalmente al mondo industriale**, che contribuiscono a creare ambienti lavorativi sicuri e processi produttivi efficienti (segnalazione acustica e luminosa per impianti industriali e spazi civili, segnalazione bordo macchina, quadristica, ecc).

La produzione 100% italiana, i forti investimenti per la ricerca e lo sviluppo e il rinnovamento continuo sono solo alcuni degli indicatori che dimostrano quanto crediamo in quello che facciamo, oggi come ieri, oggi come domani...

Sirena... Leader da sempre...



TRADITION & INNOVATION

Sirena has been designing, developing and producing top quality audible and visual signaling devices for the past 40 years.

Tradition, passion and innovation are the fundamental values of our long history that allows us to continue to do what we do best; set signaling standards.

We are proud to be the leader in the market. We now have over 200 customers in 70 countries worldwide and work with important prestigious brands in the electro-technical sector.

We are ready to accept the challenges that the future will bring with the same values that have brought us where we are today.

The constant research and development of new products allows us to supply updated solutions in terms of quality, performance and economic efficiency. All this, thanks to our R&D centre, allows us to develop in-house ranges of products that satisfy all demands that make Sirena synonymous of reliable signaling worldwide.

The **ELECTRA** range of **audible and visual devices are intended mainly for the industrial world** assuring safe and efficient production processes in working areas (audible and visual signaling in industrial installations and public areas, signaling on machines, electric panels etc).

100% made in Italy, major investments in research and development and continual innovation, are only some of the factors that are proof of our belief in what we do: today as yesterday, today as tomorrow...

Sirena... the all-time Leader...



TRADITION ET INNOVATION

Depuis plus de 40 ans, Sirena conçoit, développe et fabrique des dispositifs de signalisation acoustiques et lumineux pour le marché industriel.

La tradition, la passion et l'innovation sont les fondamentaux de notre longue histoire, ces mêmes principes nous encouragent à nous améliorer et continuer d'être un leader dans la signalisation industrielle.

Notre savoir faire sur le marché nous a permis de recueillir la confiance de plus de 200 clients dans 70 pays, en concertation avec les marques les plus prestigieuses de l'industrie électronique.

Nous nous préparons à faire face aux défis de l'avenir avec les mêmes principes.

Nous actualisons en permanence notre offre en terme de qualité, de performance et de coût. Grâce à notre centre de recherche R&D, nous sommes capables de développer des produits qui répondent à toute les applications ; Sirena est partout synonyme de sécurité dans la signalisation.

La gamme **ELECTRA** de Sirena propose des **combinés acoustiques et lumineux destinés principalement pour un environnement industriel**.

Notre production est 100% italienne, les investissements importants pour la recherche et le développement ainsi que le renouvellement continu de notre gamme font partie des indicateurs démontrant notre optimisme en notre avenir.

Sirena Leader... depuis toujours...

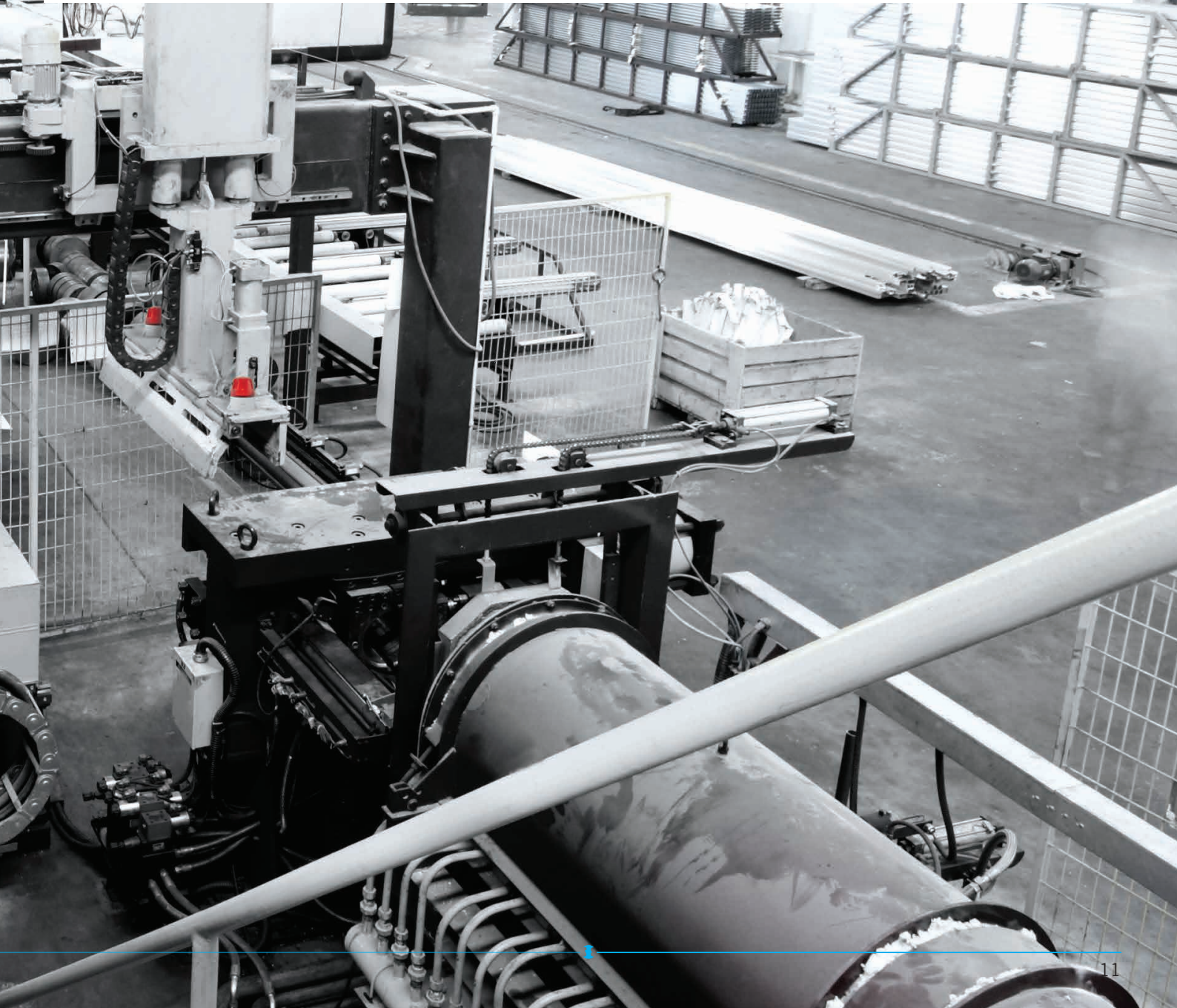

SIRENE ELETTROMECCANICHE

Le Sirene Elettromeccaniche sono una gamma storica Sirena, progettata per la segnalazione generica e di allertamento da pericoli incombenti.

Il suono molto caratteristico è generato da un motore elettrico e da una ventola e consiste in un fischio continuo. La particolarità di questo suono lo rende inconfondibile e facilmente riconducibile all'impiego a cui è destinato.

Le Sirene Elettromeccaniche sono adatte per segnalazioni di breve durata e non per servizio continuo; emettono un suono lineare e raggiungono la frequenza fondamentale dopo un breve periodo.

CARATTERISTICHE DELLA GAMMA

Qualità e affidabilità sono caratteristiche comuni alle quattro famiglie prodotte: CELERE (disponibile in tre formati), CELEREST (dotata di speciale cupola protettiva), CELERSON (per applicazioni in grandi aree industriali), MICRO W10 (per installazioni su superfici piane orizzontali o verticali oppure per montaggio a retroquadro).

Tutte le famiglie prodotte sono caratterizzate da un'alta frequenza, ad eccezione della CELERSON, dalla dimensione importante che, grazie alla bassa frequenza, è ideale per segnalazioni di lunga portata.

La gamma offre una vasta scelta per soddisfare ogni tipo di esigenze, dalla potenza di uscita desiderata alla dimensione.

SPETTRO ACUSTICO DEL SUONO PRODOTTO DALLE SIRENE ELETTROMECCANICHE ACOUSTIC SPECTRUM DESCRIBING THE SOUND PRODUCED BY ELECTRO-MECHANICAL SIRENS SPECTRE ACOUSTIQUE DU SON PRODUIT PAR LES SIRENES ELECTROMECCANIKES

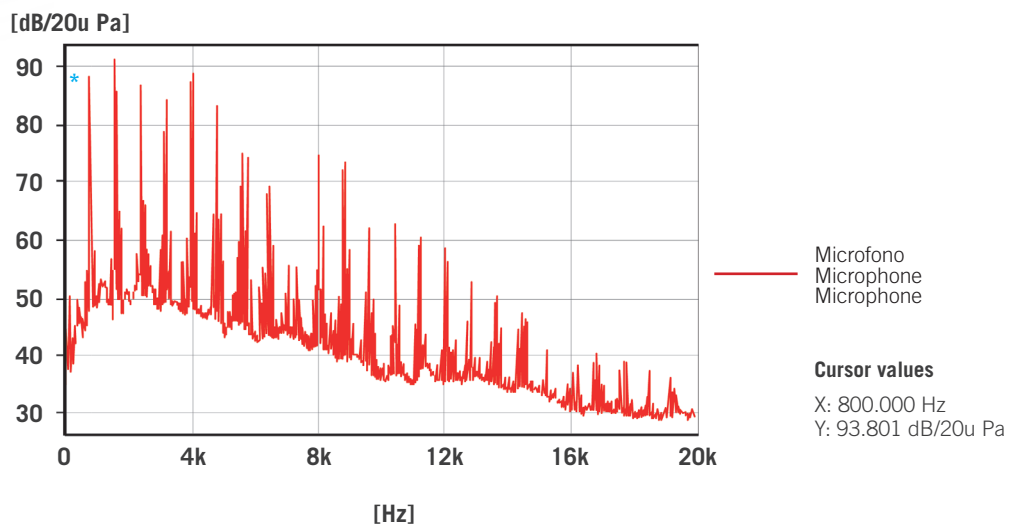

* Il primo picco è la frequenza fondamentale (800 Hz) legata ai giri del motore e al numero delle pale della ventola. Gli altri fino a 20 kHz sono le armoniche (multipli di 800 Hz).

The first peak represents the fundamental frequency (800 Hz), depending on motor revolutions and number of fan blades. The others up to 20 kHz represent the harmonics (multiples of 800 Hz).

Le premier pic correspond à la fréquence fondamentale (800 Hz) liée à la vitesse de rotation du moteur et au nombre des pales du ventilateur. Les autres, jusqu'à 20 kHz sont les harmoniques (multiples de 800 Hz).



ELECTRO-MECHANICAL SIRENS

Electro-mechanical Sirens are part of Sirena's historical range, designed for general signaling and warning of impending danger.

The characteristic sound replicates the typical features of a whistle and is generated by an electric motor connected to an internal fan. The particularity of this sound is unmistakable and is easily recognized by the users.

Electro-mechanical Sirens are suitable for short duty cycle and not for continuous operation. They produce a continuous sound and reach the fundamental frequency after a short time.

RANGE FEATURES

Quality and reliability are common characteristics of these four product families: CELERE (three versions available), CELEREST (provided with protective cap), CELERSON (for applications in large industrial areas), MICRO W10 (for flat vertical or horizontal surface mounting or alternatively for flush mount applications).

They are characterized by high frequency sound, with the exception of the CELERSON, with its large size and low frequency bass sound; it's the ideal choice for long distance signalization.

A wide range of products engineered to satisfy the most demanding requirements, from sound output to dimensions.



SIRENES ELECTROMECHANQUES

Les Sirènes Electromécaniques sont une gamme historique de Sirena, elles ont été conçues pour la signalisation sonore ou pour l'alerte d'un danger imminent.

Le son très caractéristique est généré par un moteur électrique et par un ventilateur. Il consiste en un sifflement continu. La particularité de ce son le rend unique et facilement identifiable pour l'utilisation à laquelle il est destiné.

Les Sirènes Electromécaniques sont adaptées pour des signalisations brèves et non pas pour un service continu ; elles émettent un son linéaire et atteignent la fréquence optimale après peu de temps.

CARACTERISTIQUE DE LA GAMME

Qualité et fiabilité sont les caractéristiques communes aux quatre familles de produits : CELERE (disponible en trois tailles), CELEREST (avec un chapeau spécial de protection), CELERSON (pour des applications dans les grands environnements industriels), MICRO W10 (pour l'installation sur des surfaces planes horizontales ou verticales ainsi que pour installation à encastrer).

Toutes ces familles de produits sont caractérisées par une haute fréquence à l'exception du CELERSON (de grande taille) qui grâce à sa basse fréquence est idéale pour des signalisations de longue portée.

La gamme offre un large choix pour tous types d'utilisation, telles que la puissance d'émission sonore et la taille de la sirène.

GRAFICO DIMENSIONALE / DIMENSIONAL GRAPH / GRAPHIC DIMENSIONNEL

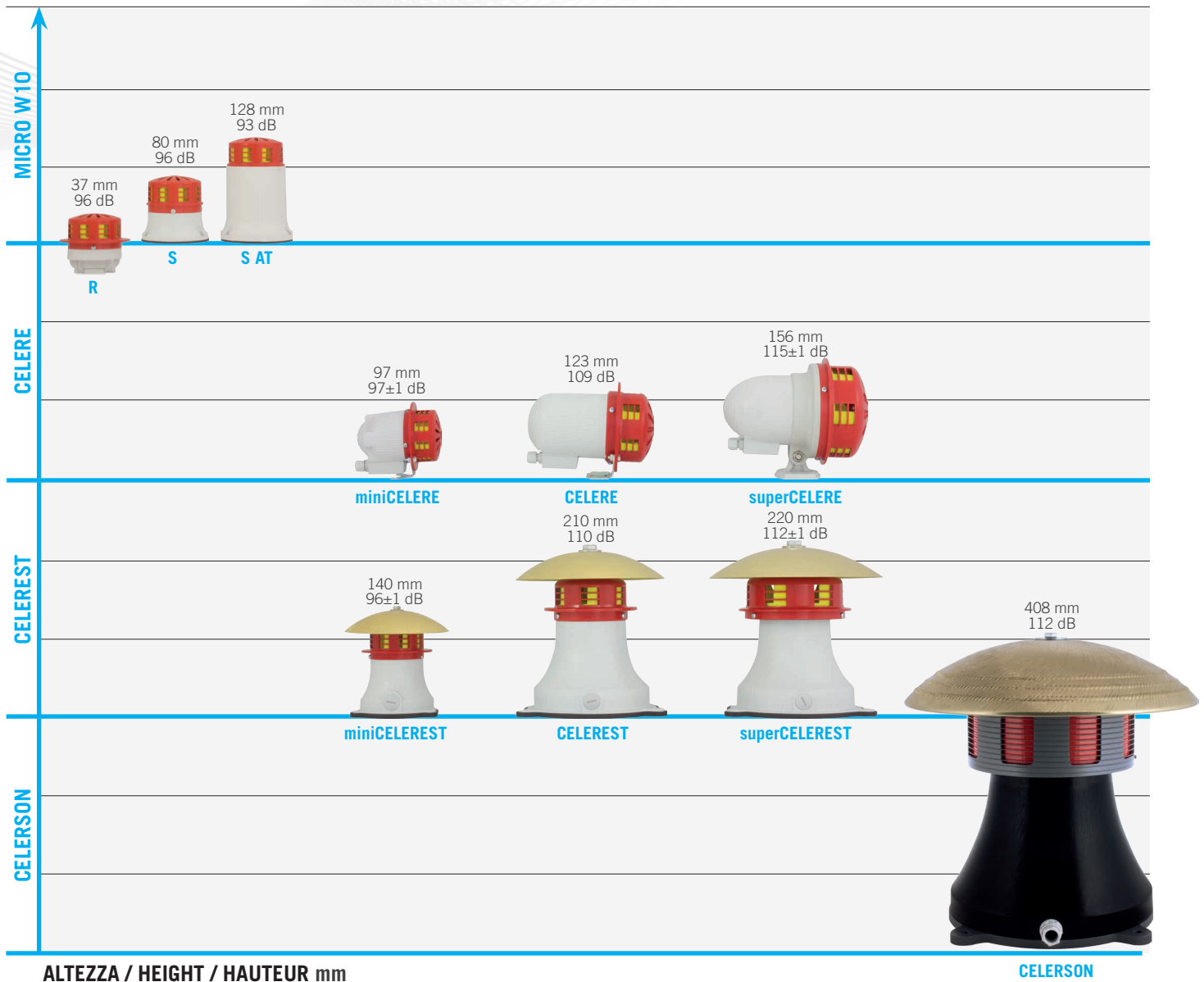

ALTEZZA / HEIGHT / HAUTEUR mm

CELERSON

CELERE

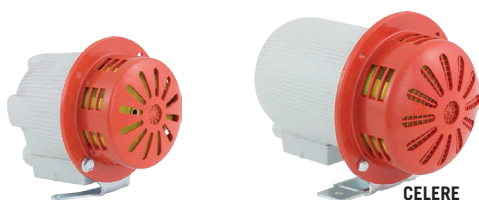

miniCELERE

CELERE



superCELERE

115 dB max

Corpo / Body / Corps



* Versioni basso assorbimento / Low consumption versions
Versions à basse consommation

miniCELERE

V ACDC	12	24	48	110	240	V DC	12	24
A	2,7	1,47	0,85	0,36	0,22	A	1,3	0,55
dB(A)1m	97 ± 1					dB(A)1m	92	95

miniCELERE BA

CELERE

V ACDC	24	48	110	240	V DC	12	24
A	7,9	3,6	1	0,70	A	2,25	1,20
dB(A)1m	109	108	104	107	dB(A)1m	95	95

CELERE BA

superCELERE

V ACDC	48	110	240	V DC	12	24
A	6	1,7	1,2	A	9,5	5,0
dB(A)1m	115 ± 1			dB(A)1m	113	113

superCELERE BA

Codici / Codes

miniCELERE

12V ACDC	42000
24V ACDC	42001
48V ACDC	42002
110V ACDC	42003
240V ACDC	42005
12V DC BA	42006
24V DC BA	42007

superCELERE

48V ACDC	42042
110V ACDC	42043
240V ACDC	42045
12V DC BA	42046
24V DC BA	42047

CELERE

24V ACDC	42021
48V ACDC	42022
110V ACDC	42023
240V ACDC	42025
12V DC BA	42026
24V DC BA	42027

Sirena elettromeccanica disponibile in 3 formati (**miniCELERE**, **CELERE** e **superCELERE**) a seconda della potenza di uscita desiderata e in versione BA a basso assorbimento. Il dispositivo è di facile installazione grazie alla pratica staffetta di fissaggio.

Tensione operativa

12V ACDC (miniCELERE), 24V ACDC (miniCELERE e CELERE), 48V ACDC, 110V ACDC, 240V ACDC +/-10%
BA: 12V DC, 24V DC +/-10%

Caratteristiche meccaniche

Corpo in policarbonato autoestinguente ad alta resistenza agli impatti. Diffusore suono in ABS. Fissaggio tramite viteria standard non fornita.

Termointerruttore di protezione motore montato nelle versioni CELERE e superCELERE.

Caratteristiche acustiche

Suono lineare. Raggiungono la frequenza fondamentale dopo un breve periodo:

miniCELERE: 1600+/-100Hz
miniCELERE BA: 1250+/-100Hz
CELERE: 1500+/-50Hz
CELERE BA: 1000+/-50Hz
superCELERE: 1000+/-100Hz
superCELERE BA: 820+/-100Hz

Certificazioni / Certifications

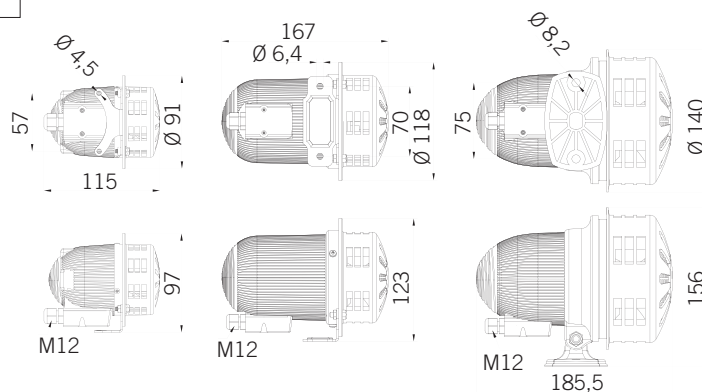

Electro-mechanical siren available in 3 different sizes (**miniCELERE**, **CELERE** and **superCELERE**) according to the desired sound output and in BA versions (low consumption). Easy installation by means of the integrated fixing bracket.

Voltages

12V ACDC (miniCELERE), 24V ACDC (miniCELERE and CELERE), 48V ACDC, 110V ACDC, 240V ACDC +/-10%
BA: 12V DC, 24V DC +/-10%

Mechanical features

Self-extinguishing PC body with high impact resistance. ABS sound speaker. Screw mounting (screws not included).

Motor protection thermal circuit breaker installed on CELERE and superCELERE versions.

Acoustic features

Continuous sound. They reach the fundamental frequency after a short time period:

miniCELERE: 1600+/-100Hz
miniCELERE BA: 1250+/-100Hz
CELERE: 1500+/-50Hz
CELERE BA: 1000+/-50Hz
superCELERE: 1000+/-100Hz
superCELERE BA: 820+/-100Hz



Sirène électromécanique disponible en 3 tailles (**miniCELERE**, **CELERE**, **superCELERE**) en fonction de la puissance sonore souhaitée et en version à basse consommation BA. Le dispositif est facile à installer grâce à sa bride de fixation.

Tension d'utilisation

12V ACDC (miniCELERE), 24V ACDC (miniCELERE et CELERE), 48V ACDC, 110V ACDC, 240V ACDC +/-10%
BA : 12V DC, 24V DC +/-10%

Caractéristiques mécaniques

Corps en polycarbonate autoextinguible, à haute résistance aux chocs. Diffuseur acoustique en ABS. Fixation par vis standards non fournies.

Interrupteur thermique de protection moteur monté dans les versions : CELERE et superCELERE.

Caractéristiques acoustiques

Son linéaire. Elles atteignent la fréquence fondamentale après peu de temps :

miniCELERE : 1600+/-100Hz
miniCELERE BA : 1250+/-100Hz
CELERE : 1500+/-50Hz
CELERE BA : 1000+/-50Hz
superCELERE : 1000+/-100Hz
superCELERE BA : 820+/-100Hz

CELEREST



112 dB max

Corpo / Body / Corps

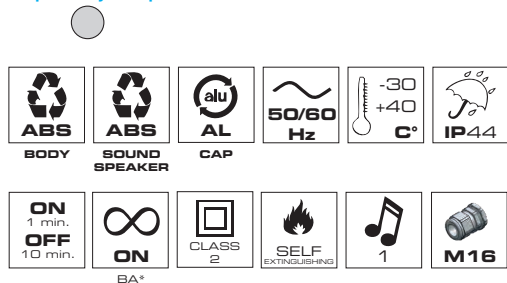

* Versioni basso assorbimento / Low consumption versions
Versions à basse consommation

miniCELEREST				miniCELEREST BA			
V ACDC	12	24	110	240	V DC	12	24
A	2,7	1,47	0,36	0,22	A	1,3	0,6
dB(A)1m	96 ± 1				dB(A)1m	92	95

CELEREST		CELEREST BA			
V ACDC	110	240	V DC	12	24
A	1	0,70	A	2,25	1,20
dB(A)1m	105	110	dB(A)1m	98	98

superCELEREST		superCELEREST BA			
V ACDC	110	240	V DC	12	24
A	1,7	1,2	A	9,5	5,0
dB(A)1m	112 ± 1		dB(A)1m	110	110

Codici / Codes

miniCELEREST

12V ACDC	42060
24V ACDC	42061
110V ACDC	42063
240V ACDC	42065
12V DC BA	42066
24V DC BA	42067

superCELEREST

110V ACDC	42103
240V ACDC	42105
12V DC BA	42106
24V DC BA	42107

CELEREST

110V ACDC	42083
240V ACDC	42085
12V DC BA	42086
24V DC BA	42087

Sirena elettromeccanica dotata di una speciale cupola protettiva in alluminio, per aumentarne la protezione dagli agenti atmosferici quando installata in ambiente esterno. Disponibile in 3 formati (miniCELEREST, CELEREST e superCELEREST) a seconda della potenza di uscita desiderata e in versione BA a basso assorbimento. Il dispositivo viene installato idealmente in posizione verticale per garantire la totale efficacia della cupola protettiva.

Tensione operativa

12V ACDC e 24V ACDC (miniCELEREST), 110V ACDC, 240V ACDC +/-10%
BA: 12V DC, 24V DC +/-10%

Caratteristiche meccaniche

Corpo in ABS autoestinguente ad alta resistenza agli impatti. Diffusore suono in ABS. Cupola protettiva in alluminio. Fissaggio tramite viteria standard non fornita.

Termointerruttore di protezione motore montato nelle versioni CELEREST e superCELEREST

Caratteristiche acustiche

Suono lineare. Raggiungono la frequenza fondamentale dopo un breve periodo:

miniCELEREST: 1600+/-100Hz
miniCELEREST BA: 1250+/-100Hz
CELEREST: 1500+/-50Hz
CELEREST BA: 1000+/-50Hz
superCELEREST: 1000+/-100Hz
superCELEREST BA: 820+/-100Hz

Certificazioni / Certifications

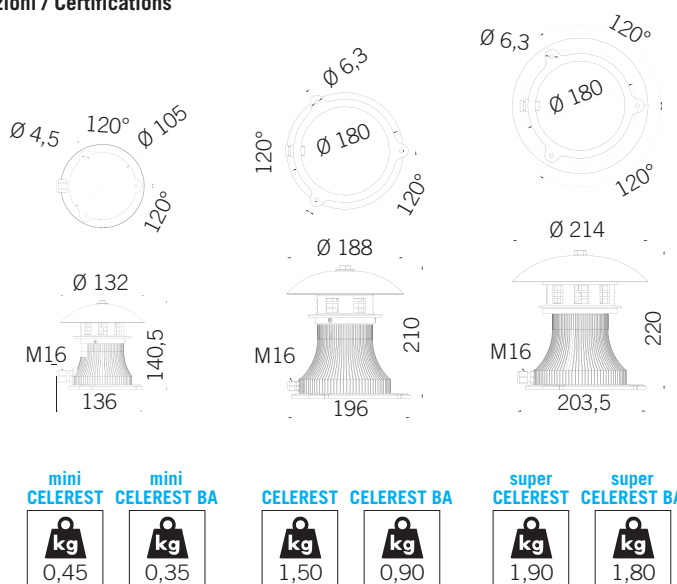

Electro-mechanical siren provided with an aluminium protective cap, increasing resistance to atmospheric agents for outdoor installation. Available in 3 different sizes (miniCELEREST, CELEREST and superCELEREST) according to the desired sound output and in BA versions (low consumption). The ideal installation in vertical position guarantees total effectiveness of the protective cap.

Voltages

12V ACDC and 24V ACDC (miniCELEREST), 110V ACDC, 240V ACDC +/-10%
BA: 12V DC, 24V DC +/-10%

Mechanical features

Self-extinguishing ABS body with high impact resistance. ABS sound speaker. Aluminium protective cap. Screw mounting (screws not included).

Motor protection thermal circuit breaker installed on CELEREST and superCELEREST versions.

Acoustic features

Continuous sound. They reach the fundamental frequency after a short time period:
miniCELEREST: 1600+/-100Hz
miniCELEREST BA: 1250+/-100Hz
CELEREST: 1500+/-50Hz
CELEREST BA: 1000+/-50Hz
superCELEREST: 1000+/-100Hz
superCELEREST BA: 820+/-100Hz



Sirène électromécanique équipée d'un chapeau spécial de protection en aluminium, pour augmenter la protection contre les intempéries lors de l'installation dans un environnement extérieur. Disponible en 3 tailles (miniCELEREST, CELEREST et superCELEREST) en fonction de la puissance sonore souhaitée et en version à basse consommation BA. Le dispositif est idéalement installé en position verticale pour assurer l'efficacité totale du chapeau de protection.

Tension d'utilisation

12V ACDC et 24V ACDC (miniCELEREST), 110V ACDC, 240V ACDC +/-10%
BA : 12V DC, 24V DC +/-10%

Caractéristiques mécaniques

Corps en ABS autoextinguible, à haute résistance aux chocs. Diffuseur acoustique en ABS. Chapeau de protection en aluminium. Fixation par vis standards non fournies.

Interrupteur thermique de protection moteur monté dans les versions : CELEREST et superCELEREST.

Caractéristiques acoustiques

Son linéaire. Elles atteignent la fréquence fondamentale après peu de temps :
miniCELEREST : 1600+/-100Hz
miniCELEREST BA : 1250+/-100Hz
CELEREST : 1500+/-50Hz
CELEREST BA : 1000+/-50Hz
superCELEREST : 1000+/-100Hz
superCELEREST BA : 820+/-100Hz

CELERSON



112 dB

Corpo / Body / Corps



CELERSON

V AC	240	380
A	2,4	1,0
dB(A)1m	112	112

PROPAGAZIONE ONDE SONORE (PORTATA DEL SUONO) DIFFUSION OF SOUND WAVES (SOUND WORKING RANGE) PROPAGATION DES ONDES SONORES (PORTEE DU SON)

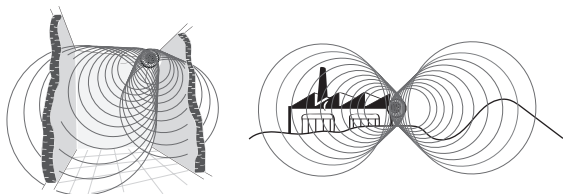

300 ÷ 500 Hz

Le onde a bassa frequenza hanno la particolare caratteristica di penetrare gli ostacoli e di propagarsi per lunghe distanze.
Low frequencies penetrate obstacles and have long distance propagation.

Les ondes de basse fréquence ont la caractéristique particulière de pénétrer les obstacles et de se propager sur de longues distances.

Codici / Codes

CELERSON

240V AC (1 PHASE)	50349
380V AC (3 PHASE)	50351

Sirena elettromeccanica di grandi dimensioni dotata di una speciale cupola protettiva in alluminio, per aumentarne la protezione dagli agenti atmosferici quando installata in ambiente esterno.

Il suono generato a bassa frequenza permette al dispositivo di coprire lunghe distanze.

Il dispositivo viene installato idealmente in posizione verticale per garantire la totale efficacia della cupola protettiva.

Tensione operativa

240V AC +/-10% (MONOFASE)

380V AC +/-10% (TRIFASE)

Caratteristiche meccaniche

Corpo, diffusore suono e cupola protettiva in alluminio. Fissaggio tramite viteria standard non fornita.

Caratteristiche acustiche

Suono lineare.

Frequenza: 390Hz

Certificazioni / Certifications

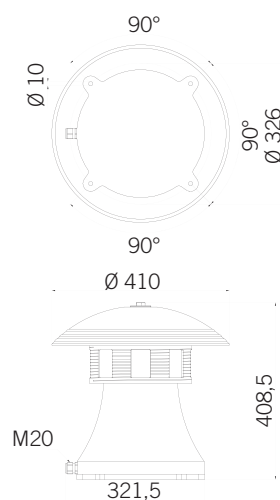

CELERSON 1 PHASE



CELERSON 3 PHASE



Large size electro-mechanical siren provided with an aluminium protective cap, increasing resistance to atmospheric agents for outdoor installation.

The low frequency bass generated sound allows long distances to be covered.

The ideal installation in vertical position guarantees total effectiveness of the protective cap.

Voltages

240V AC +/-10% (SINGLE-PHASE)

380V AC +/-10% (THREE-PHASE)

Mechanical features

Aluminium body, sound speaker and protective cap. Screw mounting (screws not included).

Acoustic features

Continuous sound.

Frequency: 390Hz



Sirène électromécanique de grande taille équipée d'un chapeau spécial de protection en aluminium, pour augmenter la protection contre les intempéries lors de l'installation dans un environnement extérieur.

La basse fréquence du son produit permet au dispositif de couvrir des longues distances.

Le dispositif est idéalement installé en position verticale pour assurer l'efficacité totale du chapeau de protection.

Tension d'utilisation

240V AC +/-10% (MONOPHASE)

380V AC +/-10% (TRIPHASE)

Caractéristiques mécaniques

Corps, diffuseur acoustique et chapeau de protection en aluminium. Fixation par vis standards non fournies.

Caractéristiques acoustiques

Son linéaire.

Fréquence : 390Hz

MICRO W10



MICRO W10 S



MICRO W10 S AT

96 dB max

Corpo / Body / Corps

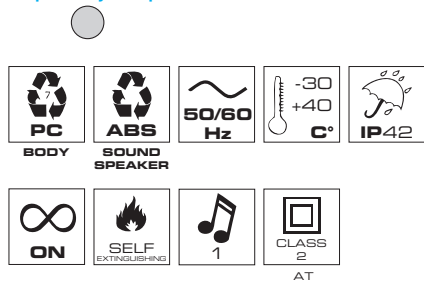

MICRO W10 S

V DC	12	24
V AC	-	24
A	1,1	0,65
dB(A)1m	94	96

MICRO W10 S AT

V AC	110	240
mA	180	120
dB(A)1m	93	93

MICRO W10 R

V DC	12	24
A	1,1	0,65
dB(A)1m	94	96

Disponibile anche / Also available / Disponible aussi



MICRO W10 R

(Versione retroquadro)
(Flush mount version)
(Version pour installation
à encastrer)

Codici / Codes

MICRO W10 S

12V DC	42200
24V DC	42202
24V AC	42203
110V AC (AT)	42210
240V AC (AT)	42212

MICRO W10 R

12V DC	42208
24V DC	42209

Sirena elettromeccanica di piccole dimensioni disponibile in 2 formati (MICRO W10 S e MICRO W10 S AT) a seconda della tensione operativa. Il dispositivo può essere installato sia in posizione verticale sia orizzontale oppure, in alternativa, a retroquadro (MICRO W10 R).

Tensione operativa

S: 12V DC, 24V DC, 24V AC +/-10%
S AT: 110V AC, 240V AC +/-10%
R: 12V DC, 24V DC +/-10%

Caratteristiche meccaniche

Corpo in polycarbonato autoestinguente ad alta resistenza agli impatti. Diffusore suono in ABS. Fissaggio tramite viteria standard non fornita.

Caratteristiche acustiche

Suono lineare. Raggiungono la frequenza fondamentale dopo un breve periodo:
MICRO W10 S e R: 1350Hz (12V) - 1500Hz (24V)
MICRO W10 S AT: 1000Hz (110V) - 1450Hz (240V)

Certificazioni / Certifications

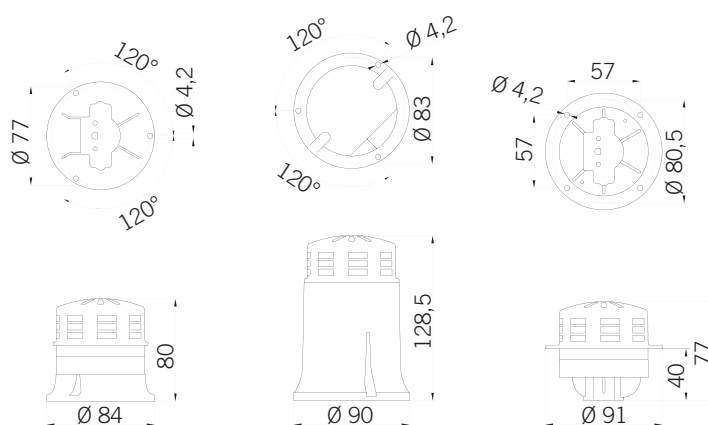

MICRO W10 S



MICRO W10 S AT



MICRO W10 R



Small size electro-mechanical siren available in 2 different sizes according to operating voltages (MICRO W10 S and MICRO W10 S AT). The device can be installed both in vertical and horizontal position, or alternatively flush mount (MICRO W10 R).

Voltages

S: 12V DC, 24V DC, 24V AC +/-10%
S AT: 110V AC, 240V AC +/-10%
R: 12V DC, 24V DC +/-10%

Mechanical features

Self-extinguishing PC body with high impact resistance. ABS sound speaker. Screw mounting (screws not included).

Acoustic features

Continuous sound. They reach the fundamental frequency after a short time period:
MICRO W10 S and R: 1350Hz (12V) - 1500Hz (24V)
MICRO W10 S AT: 1000Hz (110V) - 1450Hz (240V)



Sirène électromécanique de petite taille disponible en 2 tailles (MICRO W10 S et MICRO W10 S AT) en fonction de la tension de fonctionnement. Le dispositif peut être installé en position verticale ou horizontale ainsi que pour installation à encastrer (MICRO W10 R).

Tension d'utilisation

S: 12V DC, 24V DC, 24V AC +/-10%
S AT: 110V AC, 240V AC +/-10%
R: 12V DC, 24V DC +/-10%

Caractéristiques mécaniques

Corps en polycarbonate autoextinguible, à haute résistance aux chocs. Diffuseur acoustique en ABS. Fixation par vis standards non fournies.

Caractéristiques acoustiques

Son linéaire. Elles atteignent la fréquence fondamentale après peu de temps :
MICRO W10 S et R: 1350Hz (12V) - 1500Hz (24V)
MICRO W10 S AT: 1000Hz (110V) - 1450Hz (240V)

SIRENE ELETTRONICHE

Le Sirene Elettroniche sono dispositivi il cui suono è generato da un microprocessore su circuito elettronico. L'emissione avviene tramite altoparlante o diffusore a tromba esponenziale. Le sirene elettroniche multisuono, oltre alla selezione della tonalità tramite dip-switch, consentono di regolare il volume in dB e la progressione in durata.

Rispetto ai segnalatori di tipo elettromeccanico, presentano diversi vantaggi:

- risparmio nei consumi
- servizio continuo
- tonalità variabile nelle frequenze di suono
- possibilità di suono progressivo
- possibilità di abbinamento con segnalazione luminosa

CARATTERISTICHE DELLA GAMMA

Le famiglie prodotte di questa gamma sono sei e si suddividono a seconda del numero di toni disponibili e della potenza dell'unità magnetodinamica.

5 tonalità: SE 4 MS5 (4 watt, disponibile anche in versione compatibile PLC), SE 10 MS5 (10 watt, disponibile anche in versione compatibile PLC), SE12 MS5 (potenza 12 watt), SE 25 MS5 (potenza 25 watt).

32 tonalità: SE 12 MS32 (12 watt, disponibile anche in versione piezoelettrica), SEP LED MS32 (12 watt, con frontale luminoso a LED, disponibile anche in versione piezoelettrica).

Le Sirene Elettroniche, inoltre, sono caratterizzate da un'alta frequenza e sono pertanto idonee a segnalazioni di breve portata.

TIPOLOGIE SUONI E DESCRIZIONE / SOUND TYPES AND DESCRIPTION / TYPES DE SONS ET DESCRIPTION

I suoni emessi dalle sirene elettroniche, sono riconducibili a 5 tipologie diverse e ad ognuna è possibile attribuire un significato.

Five different sound types can be generated by electronic sirens, each distinguished by a specific meaning.

Les sons émis par les sirènes électroniques appartiennent à 5 types différents et on peut attribuer à chacun une signification.

INTERMITTENTE

Intervalli regolari tra ciclo on e off.

Indica un pericolo e la necessità di una reazione urgente.



INTERMITTENT

Regular intervals between on and off cycles.

Used to indicate a danger that requires an immediate action.



PULSE

Intervalles réguliers entre le cycle initial et final.

Indique un danger et la nécessité d'une réaction immédiate.

LINEARE

Suono continuo in una determinata frequenza.

Indica lo stato di sicurezza e quindi la fine di una situazione di allarme.

CONTINUOUS

Continuous tone in a specific frequency.

Indicates a safety status and the end of danger.

LINEAIRE

Son continu avec une fréquence définie.

Indique un état de sécurité et donc la fin d'un état d'alerte.

BITONALE

Successione ciclica e regolare di suoni con frequenze diverse.

Indica un grave pericolo e un intervento immediato.

TWO-TONE

Cyclic and regular sequence of tones with different frequencies.

Indicates a serious danger that requires an immediate action.

BITONAL

Suite cyclique et régulière de sons avec différentes fréquences.

Indique un danger grave et la nécessité d'une action immédiate.

PLURITONALE

Successione ciclica (veloce) e regolare di suoni con frequenze diverse.

Indica un grave pericolo e un intervento immediato.

MULTI-TONE

Cyclic (fast) and regular sequence of tones with different frequencies.

Indicates a serious danger that requires an immediate action.

MULTI-FREQUENCES

Suite cyclique (rapide) et régulière de sons avec différentes fréquences.

Indique un danger grave et la nécessité d'une action immédiate.

MODULATO

Suono continuo generato dall'alternanza graduale delle frequenze.

Indica un grave pericolo e un intervento immediato.

MODULATED

Continuous tone generated by graduated alternation of frequencies.

Indicates a serious danger that requires an immediate action.

ALTERNE

Son continu produit par l'alternance graduelle des fréquences.

Indique un danger grave et la nécessité d'une action immédiate.



ELECTRONIC SIRENS

Electronic Sirens are signals whose sound is generated by a microprocessor. The sound is emitted by a loudspeaker or an exponential horn. Multi-tone sirens allow tone selection by a dip-switch, as well as dB sound pressure level and sound progression regulation.

These devices have the following advantages over electro-mechanical sirens:

- low power consumption
- continuous operation
- variable tone in the sound frequency
- progressive sound
- combined audible/visual signal

RANGE FEATURES

Six product families belong to this range, distinguished according to the available number of tones and sound power of the magnetodynamic unit.

5 tones: SE 4 MS5 (4 watt, PLC version also available), SE 10 MS5 (10 watt, PLC version also available), SE 12 MS5 (12 watt sound power), SE 25 MS5 (25 watt sound power).

32 tones: SE 12 MS32 (12 watt, piezoelectric version also available), SEP LED MS32 (12 watt with LED light, piezoelectric version also available).

Electronic sirens are characterized by high frequency sound, suitable for short distance use.



SIRENES ELECTRONIQUES

Les Sirènes Electroniques sont des dispositifs dont le son est produit par un circuit électronique à microprocesseur. L'émission acoustique s'opère par haut-parleur ou diffuseur à chambre de compression. Les sirènes électroniques multi-sons permettent de sélectionner la tonalité par dip-switch et de régler le volume en dB ainsi que le temps nécessaire pour l'atteindre.

Les sirènes électroniques, par rapport aux dispositifs de signalisation électromécaniques, ont les avantages suivants :

- moindre consommation
- service continu
- tonalité variable dans les fréquences de son
- possibilité d'intensité sonore progressive
- possibilité d'intégration avec la signalisation lumineuse

CARACTERISTIQUE DE LA GAMME

Six familles de produits constituent cette gamme, réparties selon le nombre de sons disponibles et selon la puissance de l'unité magnétodynamique.

5 sons : SE 4 MS5 (4 watt, également disponibles en version PLC compatible avec API), SE 10 MS5 (10 watt, également disponibles en version PLC compatible avec API), SE 12 MS5 (puissance 12 watt), SE 25 MS5 (puissance 25 watt).

32 sons : SE 12 MS32 (12 watt, également disponible en version piézoélectriques), SEP LED MS32 (12 watt, avec lumière LED frontale, également disponible en version piézoélectrique).

Les sirènes électroniques sont caractérisées par une haute fréquence et sont donc indiquées pour des signalisations de faible portée.

LIVELLO ACUSTICO DELLE SIRENE ELETTRONICHE / ELECTRONIC SIRENS SOUND PRESSURE LEVEL NIVEAU ACOUSTIQUE DES SIRENES ELECTRONIQUES

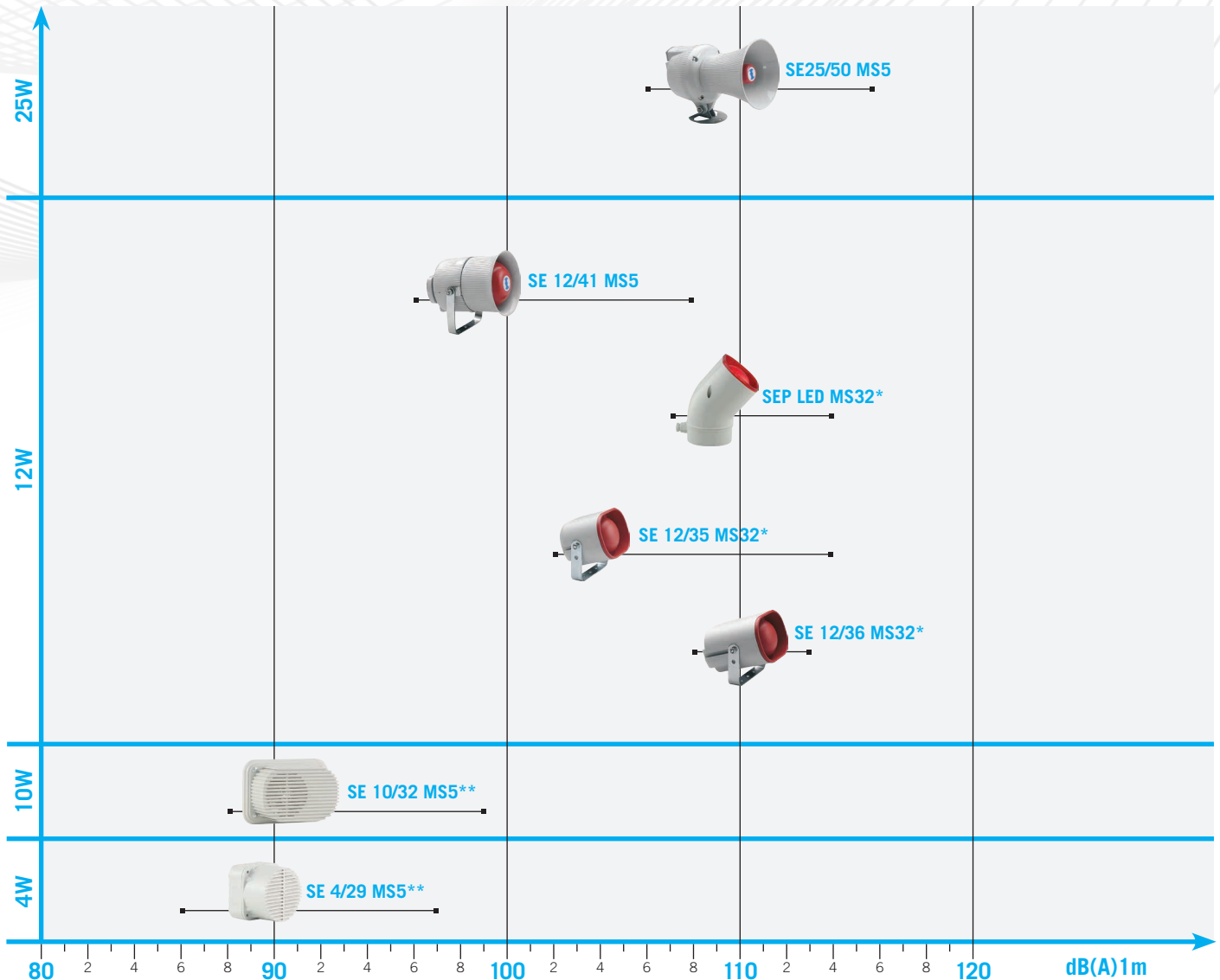

* Disponibili anche con unità piezoelettrica / With piezoelectric unit also available / Disponibles aussi avec unité piézoélectrique

** Disponibili versioni per funzionamento tramite PLC / PLC versions available / Disponibles versions PLC compatibles avec API



SE 4 MS5/PLC



SE 4/29 MS5



SE 4/25 L PLC

97 dB max

Corpo / Body / Corps



SE 4/29 MS5

V ACDC	12 ÷ 24	-	-
V AC	-	110	240
mA	350	380	55
dB(A)1m	min 86 - max 97		

SE 4/25 L PLC

V DC	24
mA	120
dB(A)1m	93

Codici / Codes

SE 4/29 MS5

12/24V ACDC	50415
110V AC	50417
240V AC	50418

SE 4/25 L PLC

24V DC	50414
--------	-------

Sirene elettroniche sviluppate con unità magnetodinamica da 4W. Disponibili nella versione multisuono, selezionabile tramite dip-switch, (SE 4/29 MS5) oppure con suono lineare per funzionamento tramite PLC (SE 4/25 L PLC).

La versione multisuono consente la regolazione del volume da un livello minimo ad uno massimo ed è inoltre possibile impostare il tempo necessario a raggiungere il livello di volume selezionato.

Tensione operativa

SE 4/29 MS5: 12/24V ACDC, 110V AC, 240V AC +/-10%

SE 4/25 PLC: 24V DC +/-10%

Caratteristiche meccaniche

Corpo in ABS. Fissaggio tramite viteria standard non fornita.

Caratteristiche acustiche

Unità magnetodinamica da 4W

Cinque suoni selezionabili tramite dip-switch:

Lineare: 1000Hz

Bitonale: 600/700Hz

Pluritonale: 1000/1700Hz

Modulato: 1000/1700Hz

Bitonale per Evacuazione: 440/560Hz

SE 4/25 PLC: Lineare (1000Hz)

Certificazioni / Certifications

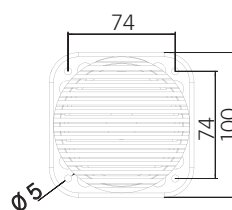
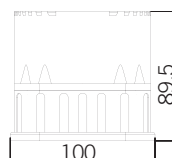

SE 4/29 MS5

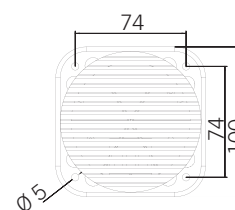

SE 4/25 PLC



Electronic sirens developed with 4W magnetodynamic unit, these devices are available in multi-tone version (SE 4/29 MS5), selectable via dip-switch, or with continuous sound for use with PLC (SE 4/25 L PLC).

The multi-tone version allows volume level (from min. to max.) and sound progression regulation (time required to reach the sound level set).

Voltages

SE 4/29 MS5: 12/24V ACDC, 110V AC, 240V AC +/-10%

SE 4/25 PLC: 24V DC +/-10%

Mechanical features

ABS body. Screw mounting (screws not included).

Acoustic features

4W magnetodynamic unit

5 tones selectable via dip-switch:

Continuous: 1000Hz

Two-tone: 600/700Hz

Multi-tone: 1000/1700Hz

Modulated: 1000/1700Hz

Two-tone for Evacuation: 440/560Hz

SE 4/25 PLC: Continuous (1000Hz)



Sirènes électroniques développées avec unité magnétodynamique de 4W, les sirènes SE 4/29 MS5 sont disponibles en version multi-sons, sélectionnables par dip-switch, ou en version avec son linéaire pour commande par API (SE 4/25 L PLC).

La version multi-sons permet de régler le volume d'un niveau minimum à un niveau maximum. Il est aussi possible de définir le temps nécessaire pour atteindre le niveau de volume établi.

Tension d'utilisation

SE 4/29 MS5 : 12/24V ACDC, 110V AC, 240V AC +/-10%

SE 4/25 PLC : 24V DC +/-10%

Caractéristiques mécaniques

Corps en ABS. Fixation par vis standards non fournies.

Caractéristiques acoustiques

Unité magnétodynamique de 4W

Cinq sons sélectionnables par dip-switch :

Linéaire : 1000Hz

Bitonal : 600/700Hz

Multi-fréquences : 1000/1700Hz

Alterné : 1000/1700Hz

Bitonal pour Evacuation : 440/560Hz

SE 4/25 PLC : Linéaire (1000Hz)

SE 10 MS5

SE 10/32 MS5
SE 10/32 MS5 PLC

99 dB max

Corpo / Body / Corps



SE 10/32 PLC



SE 10/32 MS5

V ACDC	12 ÷ 24	-	-
V AC	-	110	240
mA	170	400	55
dB(A)1m	min 88 - max 99		

SE 10/32 MS5 PLC

V DC	24
mA	370
dB(A)1m	min 93 - max 96

Codici / Codes

SE 10/32 MS5

12/24V ACDC	50419
110V AC	50421
240V AC	50422

SE 10/32 MS5 PLC

24V DC	50423
--------	-------

Sirene elettroniche sviluppate con unità magnetodinamica da 10W. Disponibili nella versione multisuono, selezionabile tramite dip-switch, (SE 10/32 MS5) oppure multisuono selezionabile tramite PLC (SE 10/32 MS5 PLC).

Consentono la regolazione del volume da un livello minimo ad uno massimo ed è inoltre possibile impostare il tempo necessario a raggiungere il livello di volume selezionato.

Tensione operativa

SE 10/32 MS5: 12/24V ACDC, 110V AC, 240V AC +/-10%

SE 10/32 MS5 PLC: 24V DC +/-10%

Caratteristiche meccaniche

Corpo in ABS. Fissaggio tramite viteria standard non fornita.

Caratteristiche acustiche

Unità magnetodinamica da 10W

Cinque suoni selezionabili tramite dip-switch:

Lineare: 1000Hz

Bitonale: 600/700Hz

Pluritonale: 1000/1700Hz

Modulato: 1000/1700Hz

Bitonale per Evacuazione: 440/560Hz

Certificazioni / Certifications

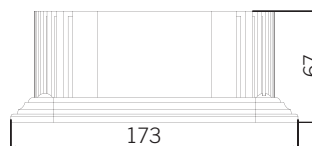
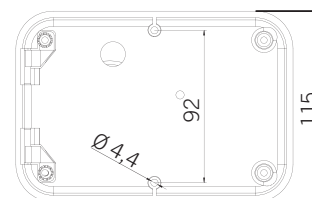

SE 10/32

SE 10/32
PLC

Electronic sirens developed with 10W magnetodynamic unit, these devices are available in multi-tone version (SE 10/32 MS5), selectable via dip-switch, or multi-tone for use with PLC (SE 10/32 MS5 PLC).

These electronic sirens allow volume level (from min. to max.) and sound progression regulation (time required to reach the sound level set).

Voltages

SE 10/32 MS5: 12/24V ACDC, 110V AC, 240V AC +/-10%

SE 10/32 MS5 PLC: 24V DC +/-10%

Mechanical features

ABS body. Screw mounting (screws not included).

Acoustic features

10W magnetodynamic unit

5 tones selectable via dip-switch:

Continuous: 1000Hz

Two-tone: 600/700Hz

Multi-tone: 1000/1700Hz

Modulated: 1000/1700Hz

Two-tone for Evacuation: 440/560Hz



Sirènes électroniques développées avec unité magnétodynamique de 10W, les sirènes sont disponibles en version multi-sons (SE 10/32 MS5), sélectionnables par dip-switch, ou en version multi-sons sélectionnables par API (SE 10/32 MS5 PLC).

Ces versions permettent de régler le volume d'un niveau minimum à un niveau maximum. Il est aussi possible de définir le temps nécessaire pour atteindre le niveau de volume établi.

Tension d'utilisation

SE 10/32 MS5 : 12/24V ACDC, 110V AC, 240V AC +/-10%

SE 10/32 MS5 PLC : 24V DC +/-10%

Caractéristiques mécaniques

Corps en ABS. Fixation par vis standards non fournies.

Caractéristiques acoustiques

Unité magnétodynamique de 10W

Cinq sons sélectionnables par dip-switch :

Linéaire : 1000Hz

Bitonale : 600/700Hz

Multi-fréquences : 1000/1700Hz

Alterné : 1000/1700Hz

Bitonale pour Evacuation : 440/560Hz

SE 12 MS5



SE 12/41 MS5

108 dB max

Corpo / Body / Corps



SE 12/41 MS5

V ACDC	12 ÷ 24	-	-
V AC	-	110	240
mA	500	760	100
dB(A)1m	min 96 - max 108		

Codici / Codes

SE 12/41 MS5

12/24V ACDC	50401
110V AC	50403
240V AC	50404

Sirena elettronica sviluppata con unità magnetodinamica da 12W. Dispone di cinque suoni selezionabili tramite dip-switch. Consente la regolazione del volume da un livello minimo ad uno massimo ed è inoltre possibile impostare il tempo necessario a raggiungere il livello di volume selezionato.

Il dispositivo è di facile installazione grazie alla pratica staffetta di fissaggio.

Tensione operativa

12/24V ACDC, 110V AC, 240V AC +/-10%

Caratteristiche meccaniche

Corpo e diffusore suono in ABS.

Caratteristiche acustiche

Unità magnetodinamica da 12W

Cinque suoni selezionabili tramite dip-switch:

Lineare: 1000Hz

Bitonale: 600/700Hz

Pluritonale: 1000/1700Hz

Modulato: 1000/1700Hz

Bitonale per Evacuazione: 440/560Hz

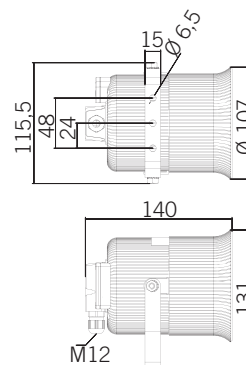
Certificazioni / Certifications

SE 12/41



Electronic siren developed with 12W magnetodynamic unit. This device benefits from five different tones selectable via dip-switch and allows volume level (from min. to max.) as well as sound progression regulation (time required to reach the sound level set).

Easy installation by means of the integrated fixing bracket.

Voltages

12/24V ACDC, 110V AC, 240V AC +/-10%

Mechanical features

ABS body and sound speaker.

Acoustic features

12W magnetodynamic unit

5 tones selectable via dip-switch:

Continuous: 1000Hz

Two-tone: 600/700Hz

Multi-tone: 1000/1700Hz

Modulated: 1000/1700Hz

Two-tone for Evacuation: 440/560Hz



Sirène électronique développée avec unité magnétodynamique de 12W, elle dispose de cinq sons sélectionnables par dip-switch. Cette version permet de régler le volume d'un niveau minimum à un niveau maximum. Il est aussi possible de définir le temps nécessaire pour atteindre le niveau de volume établi.

Le dispositif est facile à installer grâce à sa bride de fixation.

Tension d'utilisation

12/24V ACDC, 110V AC, 240V AC +/-10%

Caractéristiques mécaniques

Corps et diffuseur acoustique en ABS.

Caractéristiques acoustiques

Unité magnétodynamique de 12W

Cinq sons sélectionnables par dip-switch :

Linéaire : 1000Hz

Bitonal : 600/700Hz

Multi-fréquences : 1000/1700Hz

Alterné : 1000/1700Hz

Bitonal pour Evacuation : 440/560Hz

SE 12 MS32

SE 12/35 MS32
SE PZ/35 MS32SE 12/36 MS32
SE PZ/36 MS32

118 dB max

Corpo / Body / Corps

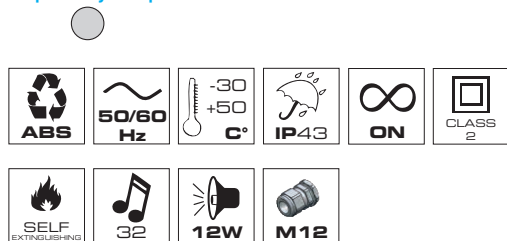

SE 12/35 MS32

V ACDC	12 ÷ 24
mA	890 1200
dB(A)1m	min 102 - max 118

SE 12/36 MS32

V AC	110	240
mA	130	65
dB(A)1m	min 108 - max 117	

SE PZ/35 MS32

V ACDC	12 ÷ 24
mA	530 240
dB(A)1m	min 98 - max 106

SE PZ/36 MS32

V AC	110	240
mA	35	15
dB(A)1m	min 99 - max 104	

Codici / Codes

SE 12/35 MS32

12/24V ACDC 50424

SE 12/36 MS32

110V AC 50426
240V AC 50427

SE PZ/35 MS32

12/24V ACDC 50428

SE PZ/36 MS32

110V AC 50430
240V AC 50431

Sirene elettroniche sviluppate con unità magnetodinamica da 12W (SE 12/35, SE 12/36) e con unità piezoelettrica (SE PZ/35, SE PZ/36).

Dispongono di 32 suoni selezionabili tramite dip-switch. Consentono la regolazione del volume da un livello minimo ad uno massimo ed è inoltre possibile impostare il tempo necessario a raggiungere il livello di volume selezionato.

I dispositivi sono di facile installazione grazie alla pratica staffetta di fissaggio.

Tensione operativa

SE 12/35 - SE PZ/35: 12/24V ACDC +/-10%

SE 12/36 - SE PZ/36: 110V AC, 240V AC +/-10%

Caratteristiche meccaniche

Corpo e diffusore suono in ABS.

Caratteristiche acustiche

SE 12/35 e SE 12/36: unità magnetodinamica da 12W

SE PZ/35 e SE PZ/36: unità piezoelettrica

32 suoni selezionabili tramite dip-switch (frequenze miste 300/2850Hz)

Certificazioni / Certifications

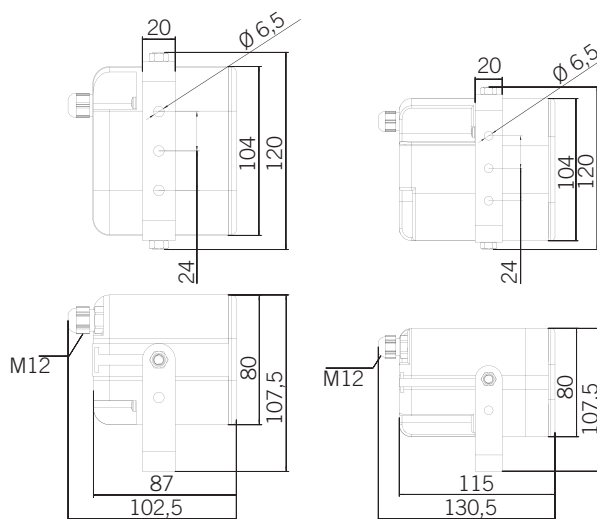

SE 12/35 SE PZ/35



SE 12/36 SE PZ/36



Electronic siren developed with 12W magnetodynamic unit (SE 12/35, SE 12/36) and with piezoelectrical unit (SE PZ/35, SE PZ/36). These electronic sirens benefit from 32 different tones, selectable via dip-switch and allow volume level (from min. to max.) and sound progression regulation (time required to reach the sound level set).

Easy installation by means of the integrated fixing bracket.

Voltages

SE 12/35 and SE PZ/35: 12/24V ACDC +/-10%

SE 12/36 - SE PZ/36: 110V AC, 240V AC +/-10%

Mechanical features

ABS body and sound speaker.

Acoustic features

SE 12/35 and SE 12/36: 12W magnetodynamic unit

SE PZ/35 and SE PZ/36: piezoelectrical unit 32 tones selectable via dip-switch (frequency range 300/2850Hz)



Sirènes électroniques développées avec unité magnétodynamique de 12W (SE 12/35, SE 12/36) ou avec unité piézoélectrique (SE PZ/35, SE PZ/36).

Les sirènes disposent de 32 sons sélectionnables par dip-switch. Elles permettent de régler le volume d'un niveau minimum à un niveau maximum. Il est aussi possible de définir le temps nécessaire pour atteindre le niveau de volume établi.

Les dispositifs sont faciles à installer grâce à la bride de fixation.

Tension d'utilisation

SE 12/35 - SE PZ/35 : 12/24V ACDC +/-10%

SE 12/36 - SE PZ/36 : 110V AC, 240V AC +/-10%

Caractéristiques mécaniques

Corps et diffuseur acoustique en ABS.

Caractéristiques acoustiques

SE 12/35 et SE 12/36 : unité magnétodynamique de 12W

SE PZ/35 et SE PZ/36 : unité piézoélectrique 32 sons sélectionnables par dip-switch (fréquences mixtes 300/2850Hz)

SE 25 MS5



SE 25/50 MS5

116 dB max

Corpo / Body / Corps



SE 25/50 MS5

V ACDC	12 ÷ 24	-	-
V AC	-	110	240
A	0,83	1,35	0,22
dB(A)1m	min 106 - max 116		

Codici / Codes

SE 25/50 MS5

12/24V ACDC	50410
110V AC	50412
240V AC	50413

Sirena elettronica sviluppata con unità magnetodinamica da 25W. Dispone di cinque suoni selezionabili tramite dip-switch. Consente la regolazione del volume da un livello minimo ad uno massimo ed è inoltre possibile impostare il tempo necessario a raggiungere il livello di volume selezionato.

Il dispositivo è di facile installazione grazie alla pratica staffetta di fissaggio.

Tensione operativa

12/24V ACDC, 110V AC, 240V AC +/-10%

Caratteristiche meccaniche

Corpo e diffusore suono in ABS.

Caratteristiche acustiche

Unità magnetodinamica da 25W

Cinque suoni selezionabili tramite dip-switch:

Lineare: 1000Hz

Bitonale: 600/700Hz

Pluritonale: 1000/1700Hz

Modulato: 1000/1700Hz

Bitonale per Evacuazione: 440/560Hz

Certificazioni / Certifications

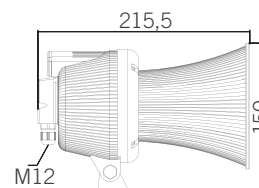
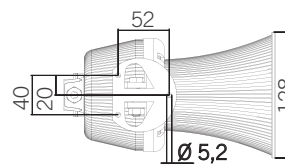

SE 25/50



Electronic siren developed with 25W magnetodynamic unit. This device benefits from five different tones selectable via dip-switch and allows volume level (from min. to max.) as well as sound progression regulation (time required to reach the sound level set).

Easy installation by means of the integrated fixing bracket.

Voltages

12/24V ACDC, 110V AC, 240V AC +/-10%

Mechanical features

ABS body and sound speaker.

Acoustic features

25W magnetodynamic unit

5 tones selectable via dip-switch:

Continuous: 1000Hz

Two-tone: 600/700Hz

Multi-tone: 1000/1700Hz

Modulated: 1000/1700Hz

Two-tone for Evacuation: 440/560Hz



Sirène électronique développée avec unité magnétodynamique de 25W, elle dispose de cinq sons sélectionnables par dip-switch. Cette version permet de régler le volume d'un niveau minimum à un niveau maximum. Il est aussi possible de définir le temps nécessaire pour atteindre le niveau de volume établi.

Le dispositif est facile à installer grâce à sa bride de fixation.

Tension d'utilisation

12/24V ACDC, 110V AC, 240V AC +/-10%

Caractéristiques mécaniques

Corps et diffuseur acoustique en ABS.

Caractéristiques acoustiques

Unité magnétodynamique de 25W

Cinq sons sélectionnables par dip-switch :

Linéaire : 1000Hz

Bitonal : 600/700Hz

Multi-fréquences : 1000/1700Hz

Alterné : 1000/1700Hz

Bitonal pour Evacuation : 440/560Hz

SEP LED MS32



SEP LED MS32
SEP LED MS32 PZ

114 dB max

Corpo / Body / Corps

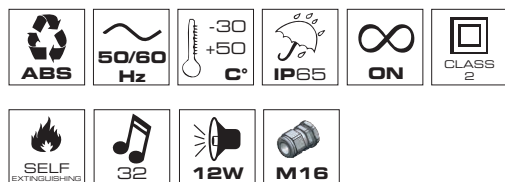

SEP LED MS32

V ACDC	24	-	-
V AC	-	110	240
mA	650	90	60
dB(A)1m	min 107 - max 114		

SEP LED MS32 PZ

V ACDC	24	-	-
V AC	-	110	240
mA	240	35	15
dB(A)1m	min 98 - max 106		

Codici / Codes

SEP LED MS32

24V ACDC	50901
110V AC	50903
240V AC	50904

SEP LED MS32 PZ

24V ACDC	50911
110V AC	50913
240V AC	50914

Sirene elettroniche multifunzione con luce a LED frontale sviluppate con unità magnetodinamica da 12W (SEP LED MS32) e con unità piezoelettrica (SEP LED MS32 PZ). Dispongono di 32 suoni selezionabili tramite dip-switch. Consentono la regolazione del volume da un livello minimo ad uno massimo ed è inoltre possibile impostare il tempo necessario a raggiungere il livello di volume selezionato.

Tensione operativa

24V ACDC, 110V AC, 240V AC +/-10%

Caratteristiche meccaniche

Corpo e diffusore suono in ABS. Fissaggio a parete tramite viteria standard non fornita.

Caratteristiche acustiche

SEP LED MS32: unità magnetodinamica da 12W

SEP LED MS32 PZ: unità piezoelettrica

32 suoni selezionabili tramite dip-switch (frequenze miste 300/2850Hz)

Caratteristiche luminose

Luce lampeggiante prodotta da 8 LED di colore rosso.

Certificazioni / Certifications

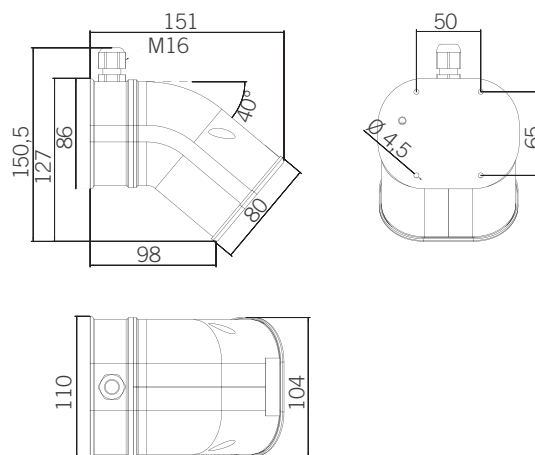

SEP LED



SEP LED 24V



SEP LED PZ



SEP LED PZ 24V



Electronic sirens developed with 12W magnetodynamic unit (SEP LED MS32) and with piezoelectrical unit (SEP LED MS32 PZ). These electronic sirens benefit from 32 different tones, selectable via dip-switch and allow volume level (from min. to max.) and sound progression regulation (time required to reach the sound level set).

Voltages

24V ACDC, 110V AC, 240V AC +/-10%

Mechanical features

ABS body and sound speaker. Wall mounting (screws not included).

Acoustic features

SEP LED MS32: 12W magnetodynamic unit

SEP LED MS32 PZ: piezoelectrical unit

32 tones selectable via dip-switch (frequency range 300/2850Hz)

Optical features

8 red LEDs producing a flashing light effect.



Sirènes électroniques développées avec unité magnétodynamique de 12W (SEP LED MS32) ou avec unité piézoélectrique (SEP LED MS32 PZ). Les sirènes disposent de 32 sons sélectionnables par dip-switch. Elles permettent de régler le volume d'un niveau minimum à un niveau maximum. Il est aussi possible de définir le temps nécessaire pour atteindre le niveau de volume établi.

Tension d'utilisation

24V ACDC, 110V AC, 240V AC +/-10%

Caractéristiques mécaniques

Corps et diffuseur acoustique en ABS. Fixation en applique par vis standards non fournies.

Caractéristiques acoustiques

SEP LED MS32 : unité magnétodynamique de 12W

SEP LED MS32 : unité piézoélectrique

32 sons sélectionnables par dip-switch (fréquences mixtes 300/2850Hz)

Caractéristiques optiques

Lumière clignotante produite par 8 LED rouges.

AVVISATORI ACUSTICI

Gli Avvisatori Acustici elettromagnetici emettono suoni caratteristici e si suddividono, in base alla generazione del suono, in due gruppi:

- avvisatori acustici a membrana vibrante
- suonerie a pistone battente su campana. La campana è disponibile in diametri diversi per ottenere suoni differenti

Il suono degli Avvisatori Acustici è immediatamente percepibile e differenziabile. Il suono generato viene percepito come un suono "non pulito", che ricorda quasi un gracchio.

CARATTERISTICHE DELLA GAMMA

Gli Avvisatori Acustici sono segnalatori a bassa frequenza, a maggior portata e idonei per brevi segnalazioni di chiamata o di allarme.

Il suono da essi emesso può essere continuo (versioni C) o intermittente (versioni I).

Le famiglie prodotte sono cinque: gli avvisatori a membrana vibrante come BABYSAI LED (con indicazione luminosa a LED), MICROSAI (diametro 114), SAI (diametro 170), SEM (clacson elettromagnetici con possibilità di segnalazione luminosa integrata) e le campane a pistone battente (disponibili in diverse dimensioni).

Il grafico mostra l'ingombro dei dispositivi considerando la base di fissaggio, a differenza del SEM per il quale è stato considerato il suo ingombro in altezza.

Il colore rosso presente per la famiglia SIAD, è particolarmente adatto alla segnalazione in caso di emergenza.





INDUSTRIAL HORNS

Industrial Horns produce distinct sounds; they include two groups, distinguished by sound generation:

- acoustic warning devices with vibrating membrane (horns)
- bells using a vibrating piston. The bell is available in different sizes in order to obtain varied sounds

The sound produced by Electromagnetic Industrial Horns is easily distinguishable and is perceived as a croaking sound.

RANGE FEATURES

Electromagnetic Industrial Horns have low frequencies and are particularly suitable for long distance signaling and for short call or danger signals.

The sound generated can be continuous (C versions) or intermittent (I versions).

Five product families belong to this range: horns with vibrating membrane BABYSAI LED (with LED light), MICROSAI (diameter 114), SAI (diameter 170), SEM (signal horn, also with integrated luminous signalization available) and bells using a vibrating piston SIAD (different dimensions available).

The graph shows dimensions of the devices considering the fixing base, except for SEM for which we have considered the height.

Red color, available for SIAD products, is suitable for emergency signaling.



AVERTISSEURS ACOUSTIQUES

Les Avertisseurs Acoustiques électromagnétiques émettent des sons bien définis et on peut les regrouper en deux catégories suivant le son généré :

- avertisseurs acoustiques à membrane vibrante
- sonneries avec piston battant sur la cloche. La cloche est disponible en plusieurs dimensions pour produire des sons avec fréquences différentes

Le son des avertisseurs acoustiques est immédiatement reconnaissable et différentiable. Le son généré est perçu comme un son "déformé", similaire à un croassement.

CARACTERISTIQUE DE LA GAMME

Les Avertisseurs Acoustiques sont des dispositifs de basse fréquence, à plus longue portée et adaptés pour des brefs signaux d'appel ou d'alarme.

Le son peut être continu (versions C) ou pulsé (version I).

Cinq familles de produits constituent cette gamme : les avertisseurs acoustiques à membrane vibrante BABYSAI LED (avec signalisation lumineuse à LED), MICROSAI (diamètre 114), SAI (diamètre 170), SEM (klaxon électromagnétique avec signalisation lumineuse intégrée) et les sonneries industrielles avec piston battant SIAD (disponibles en différentes tailles).

Le graphique montre les dimensions des dispositifs y compris la base de fixation, sauf pour le produit SEM pour lequel a été considéré sa hauteur totale.

La couleur rouge présente pour les produits SIAD est idéale pour la signalisation en cas d'urgence.

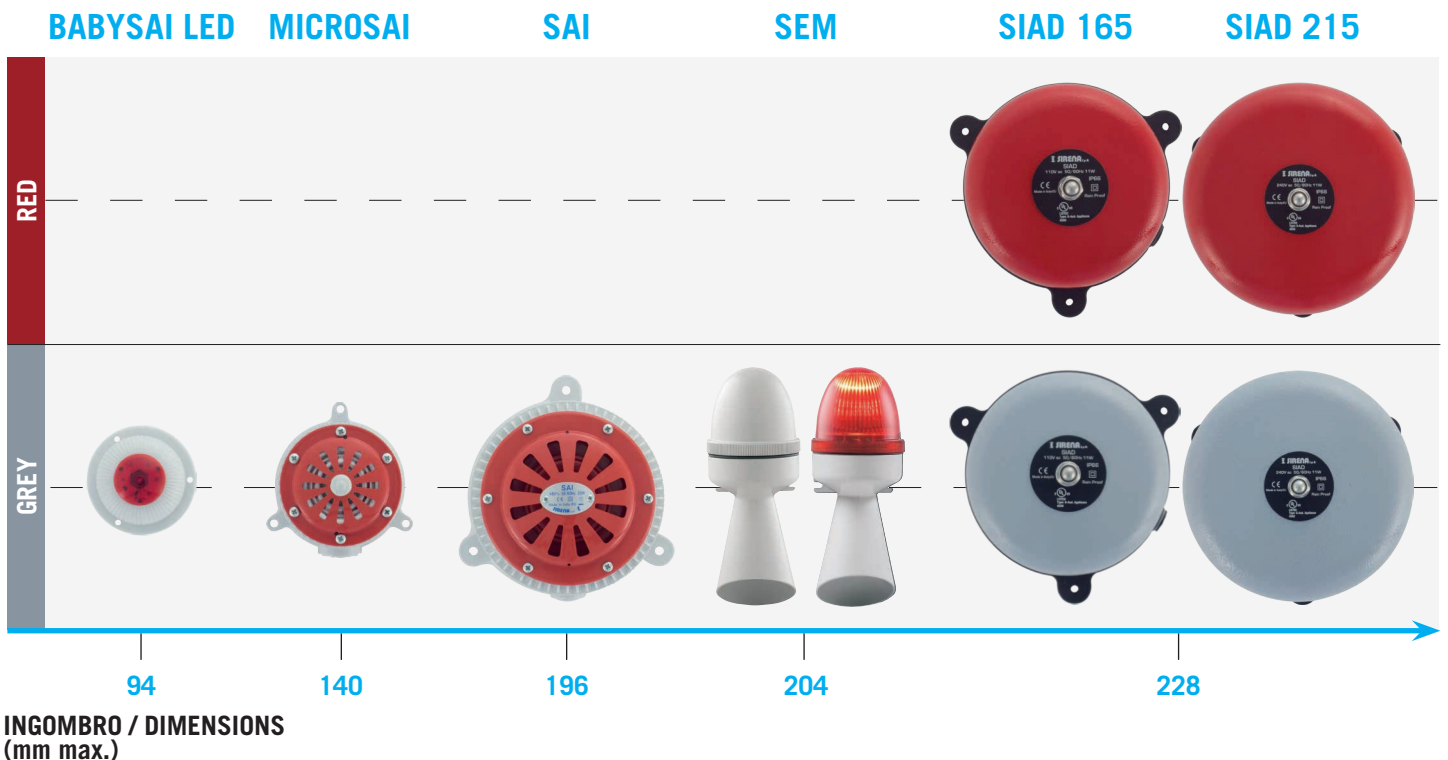

BABYSAI LED



BABYSAI LED

95 dB max

Corpo / Body / Corps

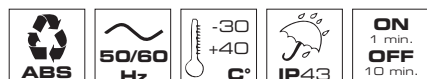

BABYSAI LED			BABYSAI LED			
V DC	12	24	V AC	24	110	240
mA	55	50	mA	145	65	35
dB(A)1m	90	95	dB(A)1m	90	95	95

Codici / Codes

BABYSAI LED

12V DC	37801
24V DC	37802
24V AC	37806
110V AC	37808
240V AC	37809

Avisatore acustico elettromeccanico di piccole dimensioni con luce a LED. **BABY SAI LED** è sviluppato con capsula acustica elettromagnetica a membrana vibrante, genera un caratteristico suono continuo. Ideale per brevi segnalazioni di chiamata o di allarme.

Tensione operativa

12V DC, 24V DC +/-10%
24V AC, 110V AC, 240V AC +/-10%

Caratteristiche meccaniche

Corpo e diffusore suono in ABS. Dotato di base piana, il fissaggio avviene con viteria standard non fornita.

Caratteristiche acustiche

Unità elettromagnetica a membrana vibrante
Suono continuo:
Versioni in DC: 650+/-50Hz
Versioni in AC: 300/7000Hz

Caratteristiche luminose

Luce fissa prodotta da 6 LED di colore rosso.

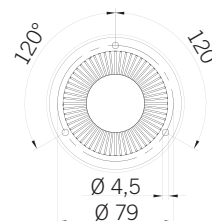
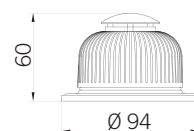
Certificazioni / Certifications

BABYSAI LED



Compact-size horn with LED light. **BABY SAI LED** has been developed with acoustic electromagnetic capsule with vibrating membrane. The device generates a characteristic continuous sound. Ideal choice for short call or danger signals.

Voltages

12V DC, 24V DC +/-10%
24V AC, 110V AC, 240V AC +/-10%

Mechanical features

ABS body and sound speaker. Provided with flat base. Screw mounting (screws not included).

Acoustic features

Electromagnetic unit with vibrating membrane
Continuous sound:
DC versions: 650+/-50Hz
AC versions: 300/7000Hz

Optical features

6 red LEDs producing steady light.



Avertisseur acoustique électromécanique de petite taille avec lumière à LED. **BABY SAI LED** a été développé avec capsule acoustique électromagnétique à membrane vibrante, il produit un caractéristique son continu. Idéal pour des brefs signaux d'appel ou d'alarme.

Tension d'utilisation

12V DC, 24V DC +/-10%
24V AC, 110V AC, 240V AC +/-10%

Caractéristiques mécaniques

Corps et diffuseur acoustique en ABS. Equipé avec base plate, fixation par vis standards non fournies.

Caractéristiques acoustiques

Unité électromagnétique à membrane vibrante
Son Continu :
Versions en DC : 650+/-50Hz
Versions en AC : 300/7000Hz

Caractéristiques optiques

Lumière fixe produite par 6 LED rouges.

MICROSAI



95 dB max

Corpo / Body / Corps

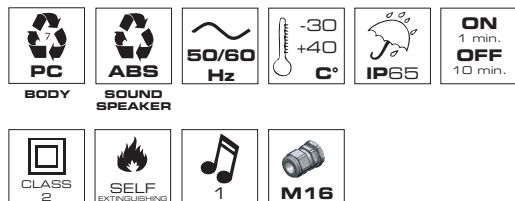

MICROSAI C

V AC	12	24	48	110	240
mA	830	415	210	90	42
dB(A)1m	95				

MICROSAI I

V AC	12	24	48	110	240
mA	850	430	220	95	45
dB(A)1m	95				

Codici / Codes

MICROSAI C

12V AC	53002
24V AC	53003
48V AC	53005
110V AC	53008
240V AC	53015

MICROSAI I

12V AC	53530
24V AC	53531
48V AC	53532
110V AC	53533
240V AC	53535

Avvisatore acustico elettromeccanico, sviluppato con capsula acustica elettromagnetica a membrana vibrante, genera un caratteristico suono continuo (MICROSAI C) oppure intermittente (MICROSAI I). Ideale per brevi segnalazioni di chiamata o di allarme.

Tensione operativa

12V AC, 24V AC, 48V AC, 110V AC, 240V AC +/-10%

Caratteristiche meccaniche

Corpo in polycarbonato e diffusore suono in ABS. Dotato di base piana, il fissaggio avviene con viteria standard non fornita.

Caratteristiche acustiche

Unità elettromagnetica a membrana vibrante

MICROSAI C: suono continuo

MICROSAI I: suono intermittente

Frequenze: 300/350Hz

Certificazioni / Certifications

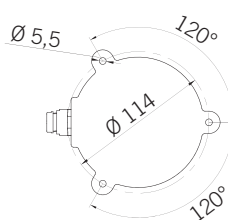
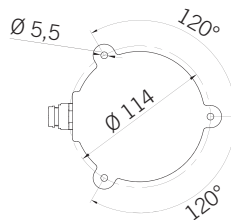
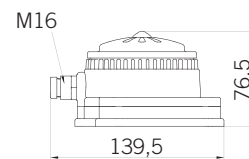
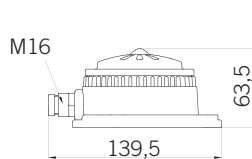

MICROSAI C



MICROSAI I



Horn developed with acoustic electromagnetic capsule with vibrating membrane. The device generates a characteristic continuous sound (MICROSAI C) or intermittent sound (MICROSAI I). Ideal choice for short call or danger signals.

Voltages

12V AC, 24V AC, 48V AC, 110V AC, 240V AC +/-10%

Mechanical features

PC body and ABS sound speaker. Provided with flat base. Screw mounting (screws not included).

Acoustic features

Electromagnetic unit with vibrating membrane

MICROSAI C: Continuous sound

MICROSAI I: Intermittent sound

Frequency: 300/350Hz



Avertisseur acoustique électromécanique, développé avec capsule acoustique électromagnétique à membrane vibrante, il produit un caractère son continu (MICROSAI C) ou pulsé (MICROSAI I). Idéal pour des brefs signaux d'appel ou d'alarme.

Tension d'utilisation

12V AC, 24V AC, 48V AC, 110V AC, 240V AC +/-10%

Caractéristiques mécaniques

Corps en polycarbonate et diffuseur acoustique en ABS. Equipé avec base plate, fixation par vis standards non fournies.

Caractéristiques acoustiques

Unité électromagnétique à membrane vibrante

MICROSAI C : Son Continu

MICROSAI I : Son pulsé

Fréquence : 300/350Hz

SAI

SAI C
SAI I

110 dB max

Corpo / Body / Corps



SAI C

V DC	12	24	48
mA	1,7	0,9	0,45
dB(A)1m	110		

SAI C - SAI I

V AC	24	48	110	240
A	1,1	0,54	0,19	0,13
dB(A)1m	105			

Codici / Codes

SAI C

12V DC	42250
24V DC	42252
48V DC	42254
24V AC	42253
48V AC	42255
110V AC	42257
240V AC	42259

SAI I

24V AC	42363
48V AC	42365
110V AC	42366
240V AC	42368

Avvisatore acustico elettromeccanico, sviluppato con capsula acustica elettromagnetica a membrana vibrante, genera un caratteristico suono continuo (SAI C) oppure intermittente (SAI I). Ideale per brevi segnalazioni di chiamata o di allarme.

Tensione operativa

SAI C: 12V DC, 24V DC, 48V DC, 24V AC, 48V AC, 110V AC, 240V AC +/-10%
SAI I: 24V AC, 48V AC, 110V AC, 240V AC +/-10%

Caratteristiche meccaniche

Corpo in policarbonato e diffusore suono in ABS. Dotato di base piana, il fissaggio avviene con viteria standard non fornita.

Caratteristiche acustiche

Unità elettromagnetica a membrana vibrante

SAI C: suono continuo

Frequenze: 600/20000Hz (DC) - 800/15000Hz (AC)

SAI I: suono intermittente

Frequenza: 800/15000Hz

Certificazioni / Certifications

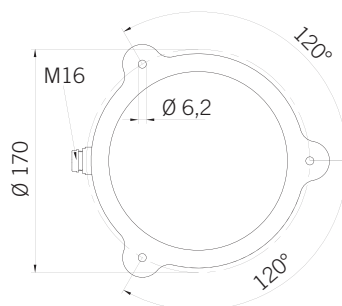
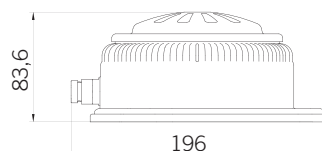

SAI



Horn developed with acoustic electromagnetic capsule with vibrating membrane. The device generates a characteristic continuous sound (SAI C) or intermittent sound (SAI I). Ideal choice for short call or danger signals.

Voltages

SAI C: 12V DC, 24V DC, 48V DC, 24V AC, 48V AC, 110V AC, 240V AC +/-10%

SAI I: 24V AC, 48V AC, 110V AC, 240V AC +/-10%

Mechanical features

PC body and ABS sound speaker. Provided with flat base. Screw mounting (screws not included).

Acoustic features

Electromagnetic unit with vibrating membrane

SAI C: Continuous sound
Frequencies: 600/20000Hz (DC) - 800/15000Hz (AC)

SAI I: Intermittent Sound
Frequency: 800/15000Hz



Avvisateur acoustique électromécanique, développé avec capsule acoustique électromagnétique à membrane vibrante, il produit un caractère son continu (SAI C) ou pulsé (SAI I). Idéal pour des brefs signaux d'appel ou d'alarme.

Tension d'utilisation

SAI C: 12V DC, 24V DC, 48V DC, 24V AC, 48V AC, 110V AC, 240V AC +/-10%

SAI I: 24V AC, 48V AC, 110V AC, 240V AC +/-10%

Caractéristiques mécaniques

Corps en polycarbonate et diffuseur acoustique en ABS. Equipé avec base plate, fixation par vis standards non fournies.

Caractéristiques acoustiques

Unité électromagnétique à membrane vibrante

SAI C: Son Continu
Fréquences: 600/20000Hz (DC) - 800/15000Hz (AC)

SAI I: Son pulsé
Fréquence: 800/15000Hz

SEM - SEM PLUS

SEM
SEM PLUS

101 dB max

Corpo / Body / Corps



SEM

V DC	12	24	110	240
mA	55	40	15	30
dB(A)1m	91	96	101	98

SEM

V AC	6÷8	12	24	48	110	240
mA	340	95	140	105	65	35
dB(A)1m	92	86	93	93	95	95

SEM PLUS

V DC	12 ÷ 24	
mA	50	140
dB(A)1m	90	92

Codici / Codes

SEM

12V DC	40302
24V DC	40304
110V DC	40308
240V DC	40310
6/8V AC	40301
12V AC	40303
24V AC	40305
48V AC	40307
110V AC	40309
240V AC	40311

SEM PLUS

12/24V DC	40312
-----------	-------

Avvisatore acustico elettromeccanico, SEM è ideale per brevi segnalazioni di chiamata o di allarme.

Disponibile anche in versione elettronica per servizio continuo (SEM PLUS).

Tensione operativa

SEM: 12V DC, 24V DC, 110V DC, 240V DC, 6/8V AC, 12V AC, 24V AC, 48V AC, 110V AC, 240V AC +/-10%

SEM PLUS: 12/24V DC +/-10%

Caratteristiche meccaniche

Corpo/diffusore suono in ABS, cupola in policarbonato. Fissaggio tramite viteria standard non fornita.

Caratteristiche acustiche

SEM: unità elettromagnetica a membrana vibrante

Suono continuo

Frequenze: 650+/-50Hz (DC) - 300/7000Hz (AC)

SEM PLUS: unità magnetodinamica pilotata elettronicamente

Frequenza: 850+/-50Hz

Certificazioni / Certifications

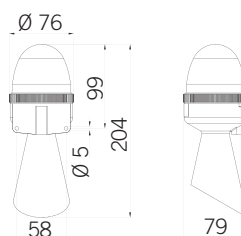
SEM
SEM PLUS

SEM is horn engineered for short call or danger signals.

Electronic version for continuous operation (SEM PLUS) also available.

Voltages

SEM: 12V DC, 24V DC, 110V DC, 240V DC, 6/8V AC, 12V AC, 24V AC, 48V AC, 110V AC, 240V AC +/-10%

SEM PLUS: 12/24V DC +/-10%

Mechanical features

ABS body/sound speaker, polycarbonate dome. Screw mounting (screws not included).

Acoustic features

SEM: Electromagnetic unit with vibrating membrane

Continuous sound

Frequencies: 650+/-50Hz (DC) - 300/7000Hz (AC)

SEM PLUS: electronically driven magnetodynamic unit

Frequency: 850+/-50Hz



Avvisateur acoustique électromécanique, SEM est idéal pour des bréfs signaux d'appel ou d'alarme.

Disponible aussi en version électronique pour service continu (SEM PLUS)

Tension d'utilisation

SEM : 12V DC, 24V DC, 110V DC, 240V DC, 6/8V AC, 12V AC, 24V AC, 48V AC, 110V AC, 240V AC +/-10%

SEM PLUS : 12/24V DC +/-10%

Caractéristiques mécaniques

Corps/diffuseur acoustique en ABS, dôme en polycarbonate. Fixation par vis standards non fournies.

Caractéristiques acoustiques

SEM : Unité électromagnétique à membrane vibrante

Son Continu

Fréquences : 650+/-50Hz (DC) - 300/7000Hz (AC)

SEM PLUS : Unité magnétodynamique commandée électroniquement

Fréquence: 850+/-50Hz

SEM LED



SEM LED

96 dB max

Cupole / Domes / Dômes Corpo / Body / Corps

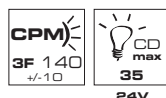
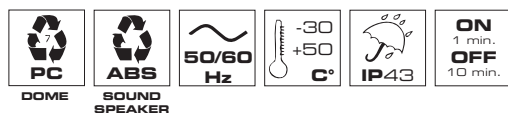

SEM LED

V DC	12	24
mA	75	65
dB(A)1m	96	

SEM LED

V AC	12	24	110	240
A	165	200	75	50
dB(A)1m	92			

Codici / Codes

SEM LED

12V DC	38822	38823	
24V DC	38842	38843	
12V AC	38832	38833	
24V AC	38852	38853	
110V AC	38862	38863	
240V AC	38872	38873	

RICAMBI CUPOLE / SPARE DOMES / DOMES DE RECHANGE

71116	71117

Avvisatore acustico elettromeccanico, ideale per brevi segnalazioni di chiamata o di allarme. SEM LED è dotato di tecnologia LED SMD ad alta luminosità ed è possibile alimentare separatamente il suono dalla luce.

Tensione operativa

12V DC, 24V DC, 12V AC, 24V AC, 110V AC, 240V AC +/-10%

Caratteristiche meccaniche

Corpo/diffusore suono in ABS, cupola in policarbonato. Fissaggio tramite viteria standard non fornita.

Caratteristiche acustiche

Unità elettromagnetica a membrana vibrante

Suono continuo

Frequenze: 650+/-50Hz (DC) - 300/7000Hz (AC)

Caratteristiche luminose

LED SMD. Possibilità di selezione delle 4 funzioni di lampeggio tramite dip-switch (luce fissa, singolo, doppio e triplo lampeggio).

Certificazioni / Certifications

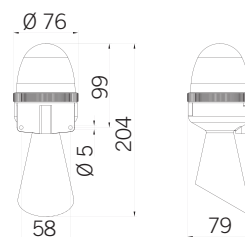

SEM LED



Horn engineered for short call or danger signals. SEM LED has been developed with superbright SMD LED and it is possible to power sound and light separately.

Voltages

12V DC, 24V DC, 12V AC, 24V AC, 110V AC, 240V AC +/-10%

Mechanical features

ABS body/sound speaker, polycarbonate dome. Screw mounting (screws not included).

Acoustic features

Electromagnetic unit with vibrating membrane

Continuous sound

Frequencies: 650+/-50Hz (DC) - 300/7000Hz (AC)

Optical features

SMD LED. It benefits from 4 light effects (steady light, single, double or triple-flash) selectable via dip-switch.



Avvisateur acoustique électromécanique, idéal pour des brefs signaux d'appel ou d'alarme. SEM LED est équipé avec une technologie LED SMD à haut rendu lumineux ; on peut alimenter séparément la lumière et le son.

Tension d'utilisation

12V DC, 24V DC, 12V AC, 24V AC, 110V AC, 240V AC +/-10%

Caractéristiques mécaniques

Corps/diffusor acoustique en ABS, dôme en polycarbonate. Fixation par vis standards non fournies.

Caractéristiques acoustiques

Unité électromagnétique à membrane vibrante

Son Continu

Fréquences : 650+/-50Hz (DC) - 300/7000Hz (AC)

Caractéristiques optiques

LED SMD. Possibilité de sélectionner 4 effets lumineux par dip-switch (lumière fixe, flash simple éclat, flash double éclat, flash triple éclat).

SIAD



SIAD 165



SIAD 215

100 dB max

Campana / Bell / Cloche

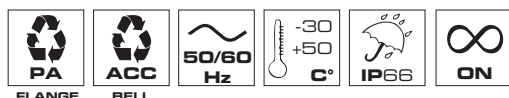

SIAD 165

V AC	12	24	110	240	V AC	240
mA	860	430	90	50	mA	50
dB(A)1m	100				dB(A)1m	100

SIAD 215

V DC	12	24	110	240	V DC	24
mA	600	300	60	28	mA	300
dB(A)1m	98				dB(A)1m	98

Codici / Codes

SIAD 165

12V AC	54200	54207
24V AC	54201	54208
110V AC	54204	54211
240V AC	54206	54213
12V DC	54214	54221
24V DC	54215	54222
110V DC	54218	54225
240V DC	54220	54227

SIAD 215

240V AC	54234	54241
24V DC	54243	54250

Campana elettromeccanica con base rinforzata disponibile nella versione **SIAD 165** (diametro 165 mm) oppure **SIAD 215** (diametro 215 mm). Sviluppata con unità elettromagnetica a pistone battente, genera un caratteristico suono continuo. La robusta struttura in acciaio della campana conferisce un'elevata resistenza agli impatti e fornisce un'alta protezione contro l'ingresso di polveri ed acqua (IP66), rendendola idonea anche per utilizzo gravoso.

Tensione operativa

SIAD 165 AC: 12V AC, 24V AC, 110V AC, 240V AC +/-10%

SIAD 165 DC: 12V DC, 24V DC, 110V DC, 240V DC +/-10%

SIAD 215 AC: 240V AC +/-10%

SIAD 215 DC: 24V DC +/-10%

Caratteristiche meccaniche

Campana in acciaio e flangia in poliammide. Dotata di base piana, il fissaggio avviene con viteria standard non fornita.

Caratteristiche acustiche

Unità elettromagnetica a pistone battente. Suono continuo

Frequenze **SIAD 165:** 1500/10000Hz

Frequenze **SIAD 215:** 1000/15000Hz

Certificazioni / Certifications

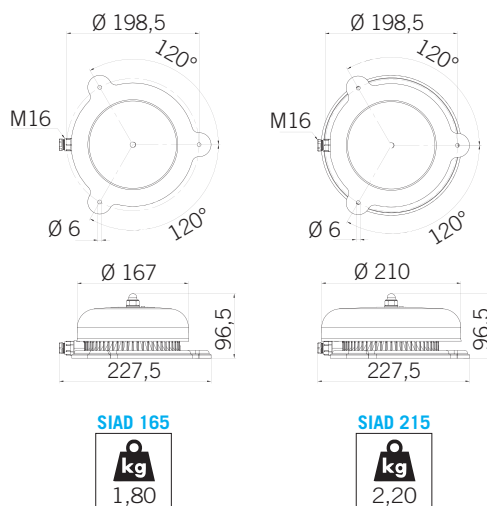

Electromechanical industrial bell with reinforced base, available with diameter 165 mm (**SIAD 165**) or 215 mm (**SIAD 215**). Developed with acoustic electromagnetic unit with vibrating piston, the device generates a characteristic continuous sound. The rugged steel structure of the bell provides high impact resistance and excellent protection against dust and water (IP66), suitable also for heavy duty applications.

Voltages

SIAD 165 AC: 12V AC, 24V AC, 110V AC, 240V AC +/-10%

SIAD 165 DC: 12V DC, 24V DC, 110V DC, 240V DC +/-10%

SIAD 215 AC: 240V AC +/-10%

SIAD 215 DC: 24V DC +/-10%

Mechanical features

Steel bell and polyamide flange. Provided with flat base. Screw mounting (screws not included).

Acoustic features

Electromagnetic unit with vibrating piston. Continuous sound

Frequency **SIAD 165:** 1500/10000Hz

Frequency **SIAD 215:** 1000/15000Hz



Sonnerie électromécanique avec base renforcée, disponible en version **SIAD 165** (diamètre 165 mm) ou **SIAD 215** (diamètre 215 mm). Equipée d'une unité électromagnétique avec piston battant sur la cloche, qui produit un caractère son continu. La structure robuste en acier de la sonnerie offre une haute résistance aux chocs et une haute protection contre la pénétration de la poussière et de l'eau (IP66), ce qui convient pour une utilisation intensive.

Tension d'utilisation

SIAD 165 AC: 12V AC, 24V AC, 110V AC, 240V AC +/-10%

SIAD 165 DC: 12V DC, 24V DC, 110V DC, 240V DC +/-10%

SIAD 215 AC: 240V AC +/-10%

SIAD 215 DC: 24V DC +/-10%

Caractéristiques mécaniques

Cloche en acier et bride en polyamide. Equipé avec base plate, fixation par vis standards non fournies.

Caractéristiques acoustiques

Unité électromagnétique avec piston battant.

Son continu

Fréquences **SIAD 165:** 1500/10000Hz

Fréquences **SIAD 215:** 1000/15000Hz

LUCI BORDO MACCHINA

Le Luci Bordo Macchina sono una gamma di prodotti di piccole dimensioni, sviluppata per soddisfare le esigenze legate alla segnalazione acustica e ottica, anche integrata, a bordo macchina, al fine di garantire la sicurezza di coloro che lavorano con impianti e macchinari e la funzionalità degli stessi.

La Direttiva Europea Macchine 2006/42/CE stabilisce infatti l'installazione obbligatoria a bordo macchina di idonei dispositivi di segnalazione acustica e luminosa, essenziali alla sicurezza degli operatori in ambito industriale.

Un dispositivo luminoso può inoltre informare un operatore se un processo è in corso o è terminato; spesso serve anche a riconoscere i fermi macchina e ad aumentare il rendimento.

CARATTERISTICHE DELLA GAMMA

Le famiglie prodotto si differenziano in base alla forma e offrono una varietà di colori, diametri e basi per soddisfare ogni tipo di applicazione. Utilizzano tecnologie di luce tradizionali (lampadina a filamento e Xenon) e fonti luminose a LED di ultima generazione (LED SMD). Le famiglie sono tre: MICROLAMP (con versione acustica), CTL (in tre formati e con versione acustica), OVOLUX (disponibile con due basi di fissaggio e in versione multicolor RGB, che consente di riprodurre sette colori predefiniti con un unico segnalatore).

Di seguito è presentata l'intera gamma attraverso un grafico che ne illustra le differenze salienti, di ingombro, di forma e di fissaggio.

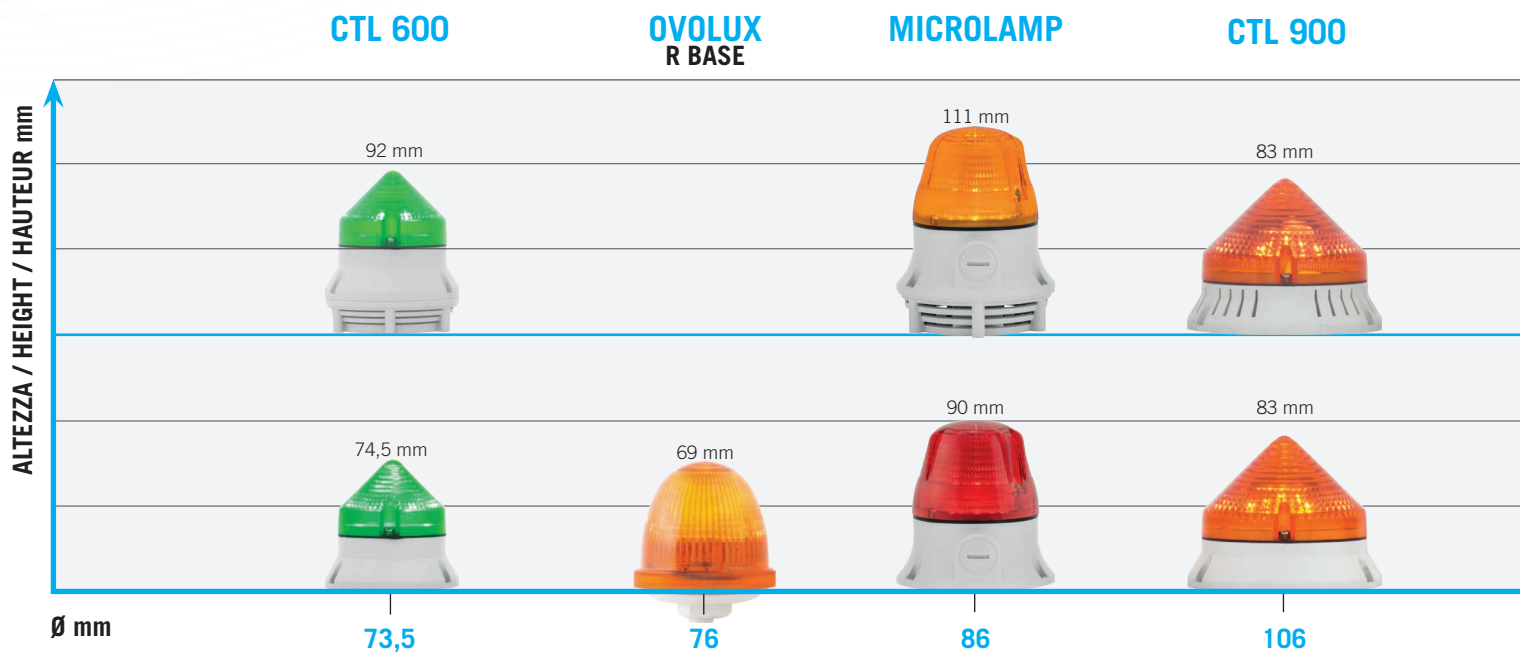



LUMINOUS DEVICES ON MACHINERY

Luminous Devices for installation on Machinery are a small size product range, developed to meet requirements relating to visual and acoustic signaling on machinery, suitable for all safety conditions of the "machinery system".

The 2006/42/EC European Machine Directive requires the installation of appropriate audible and visual warning devices in order to guarantee safety for operators and functionality of plant and machinery.

Furthermore, signaling devices can be used for numerous informative applications: they can, for example, inform the operator if a process is in progress, has been completed or can be used to detect downtime and increase productivity.

RANGE FEATURES

Families of this product category differ according to their shape and offer a variety of colors, diameters and mounting bases to satisfy the most demanding applications. They benefit from traditional luminous technologies (incandescent and Xenon bulb) as well as from the latest LED luminous sources (SMD LED): MICROLAMP (also with acoustic version), CTL (three sizes and also with acoustics) and OVOLUX (with two different mounting bases and in "multicolor" RGB version technology that allows seven different colors in just one beacon).

The following graph shows the relevant features of the whole range, relating to dimensions, shape and mounting.



FEUX DE SIGNALISATION MACHINE

Les Feux de Signalisation Machine sont une gamme de produits de petite taille, développée pour répondre aux exigences visuelles et acoustiques liées à la signalisation des machines. Même intégrée, elle garantit la sécurité des opérateurs et la fonctionnalité des installations et des machines.

La Directive Européenne Machine 2006/42/CE rend obligatoire l'installation sur les machines de dispositifs de signalisation acoustique et lumineuse, essentiels à la sécurité des opérateurs dans l'environnement industriel.

Un dispositif lumineux peut informer l'opérateur si un processus est en cours ou a été achevé ; souvent il sert aussi à reconnaître les arrêts machine et à augmenter la productivité.

CARACTERISTIQUE DE LA GAMME

Les familles de produits varient selon la forme et offrent une variété de couleurs, de diamètres et de bases pour tout type d'application. Elles utilisent des technologies lumineuses traditionnelles (ampoule à incandescence et tube à décharge au Xénon) et sources de lumière à LED de dernière génération (LED SMD). Les familles sont trois : MICROLAMP (avec version acoustique), CTL (en trois tailles et avec version acoustique) et OVOLUX (disponible avec deux bases de montage et en version "multicolor" RGB qui permet de réaliser sept couleurs prédéfinies dans un seul feu).

Voici dans le graphique la gamme complète qui illustre les différences saillantes de diamètre, forme et fixation.



OVOLUX
M BASE

CTL 1200

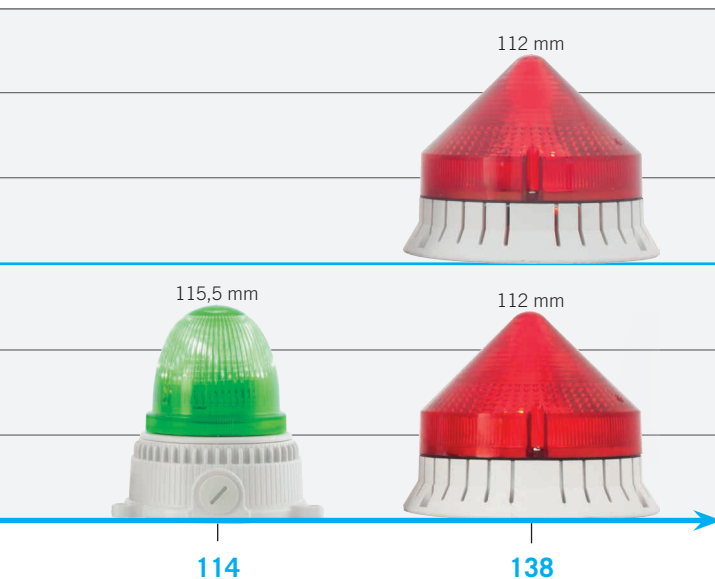

LUCE+SUONO
LIGHT+SOUND
LUMIERE+SON

LUCE
LIGHT
LUMIERE

114

138



MICROLAMP



MICROLAMP

MICROLAMP
ACOUSTIC

80 dB max

Cupole / Domes / Dômes Base

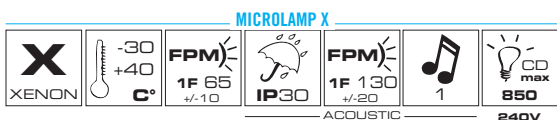
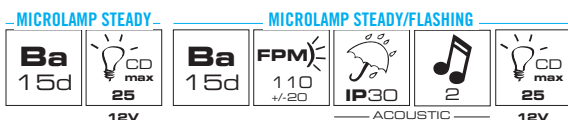

MICROLAMP STEADY

V ACDC	12 ÷ 24 ÷ 48 ÷ 110 ÷ 240
mA	415 210 105 45 21

MICROLAMP STEADY/FLASHING

V DC	12 ÷ 24 ÷ 48	-	-
V AC	-	24 ÷ 48 ÷ 110 ÷ 240	
mA	420	215	105 45 20

MICROLAMP STEADY/FLA. ACOUSTIC

V ACDC	12	24	48	-	-
V AC	-	-	-	110	240
mA	420	215	105	45	20
dB(A)1m	75				

MICROLAMP LED

V ACDC	12 ÷ 24	48	-
V AC	-	-	90÷240
mA	180	115	40

MICROLAMP X

V ACDC	12 ÷ 24	-	-
V AC	-	110	240
mA	200	160	45 45

MICROLAMP LED ACOUSTIC

V ACDC	12 ÷ 24	48	-
V AC	-	-	90÷240
mA	180	115	40
dB(A)1m	72		

MICROLAMP X ACOUSTIC

V ACDC	12 ÷ 24	-	-
V AC	-	110	240
mA	205	165	50 50
dB(A)1m	80		

Dispositivo luminoso disponibile in versione:

STEADY e **STEADY/FLASHING** con lampada a incandescenza

LED con tecnologia a LED SMD

X a flash con lampada a scarica di Xenon.

L'avvisatore è inoltre disponibile con segnalazione acustica integrata (versioni **ACOUSTIC**).

Tensione operativa

MICROLAMP STEADY: 12/240V ACDC +/-10% (fornito senza lampada)

MICROLAMP STEADY/FLASHING: 12/48V DC, 24/240V AC +/-10% (fornito senza lampada)

MICROLAMP STEADY/FLASHING ACOUSTIC: 12V ACDC, 24V ACDC, 48V ACDC, 110V AC, 240V AC +/-10% (fornito con lampada)

MICROLAMP LED e **ACOUSTIC**: 12/24V ACDC, 48V ACDC, 90/240V AC +/-10%

MICROLAMP X e **ACOUSTIC**: 12/24V ACDC, 110V AC, 240V AC +/-10% (fornito con lampada)

Caratteristiche meccaniche

Base in PC/ABS, cupola in policarbonato. Fissaggio tramite viteria standard non fornita.

Caratteristiche luminose

MICROLAMP STEADY (luce fissa), **MICROLAMP STEADY/FLASHING** e **ACOUSTIC** (luce fissa/lampeggiante) con lampada a incandescenza Ba15d 5W

MICROLAMP LED e **ACOUSTIC** (luce fissa/lampeggiante) con tecnologia LED SMD, triplo lampeggio 3F

MICROLAMP X e **ACOUSTIC** (luce a flash) con lampada Xenon, flash singolo 1F da 1J

Caratteristiche acustiche

Versioni **ACOUSTIC** con unità piezoelettrica integrata

MICROLAMP STEADY/FLASHING: suono continuo (con luce fissa) o suono intermittente F/m 130 (con luce lampeggiante). Frequenza: 2700Hz

MICROLAMP LED: suono continuo (con luce fissa) o suono intermittente F/m 180 (con luce lampeggiante). Frequenza: 3200Hz

MICROLAMP X: suono intermittente F/m 65. Frequenza: 3000+/-500Hz

Certificazioni / Certifications



Luminous device available in different versions: **STEADY** and **STEADY/FLASHING** with incandescent lamp

LED with SMD LED technology

X flashing light with Xenon discharge tube.

The device is also available with integrated acoustic signaling (**ACOUSTIC** versions).



Feu de signalisation disponible en version : **STEADY** et **STEADY/FLASHING** avec ampoule à incandescence

LED avec technologie à LED SMD

X à éclats, avec tube à décharge au Xénon.

Le dispositif est également disponible avec un signal acoustique intégré (versions **ACOUSTIC**).

Voltages

MICROLAMP STEADY: 12/240V ACDC +/-10% (supplied without bulb)

MICROLAMP STEADY/FLASHING: 12/48V DC, 24/240V AC +/-10% (supplied without bulb)

MICROLAMP STEADY/FLASHING ACOUSTIC: 12V ACDC, 24V ACDC, 48V ACDC, 110V AC, 240V AC +/-10% (supplied with bulb)

MICROLAMP LED and **ACOUSTIC**: 12/24V ACDC, 48V ACDC, 90/240V AC +/-10%

MICROLAMP X and **ACOUSTIC**: 12/24V ACDC, 110V AC, 240V AC +/-10% (supplied with bulb)

Tension d'utilisation

MICROLAMP STEADY: 12/240V ACDC +/-10% (fourni sans ampoule)

MICROLAMP STEADY/FLASHING: 12/48V DC, 24/240V AC +/-10% (fourni sans ampoule)

MICROLAMP STEADY/FLASHING ACOUSTIC: 12V ACDC, 24V ACDC, 48V ACDC, 110V AC, 240V AC +/-10% (fourni avec ampoule)

MICROLAMP LED et **ACOUSTIC**: 12/24V ACDC, 48V ACDC, 90/240V AC +/-10%

MICROLAMP X et **ACOUSTIC**: 12/24V ACDC, 110V AC, 240V AC +/-10% (fourni avec ampoule)

Mechanical features

PC/ABS base, polycarbonate dome. Screw mounting (screws not included).

Optical features

MICROLAMP STEADY (steady light), **MICROLAMP STEADY/FLASHING** and **ACOUSTIC** (steady/flashing light) with incandescent lamp Ba15d 5W

MICROLAMP LED and **ACOUSTIC** (steady/flashing light) with SMD LED technology, triple-flash 3F

MICROLAMP X and **ACOUSTIC** (Xenon flashing light) with 1J Xenon discharge tube, single flash 1F

Acoustic features

ACOUSTIC versions with integrated piezoelectric unit

MICROLAMP STEADY/FLASHING: continuous sound (with steady light) or intermittent sound F/m 130 (with flashing light). Frequency: 2700Hz

MICROLAMP LED: continuous sound (with steady light) or intermittent sound F/m 180 (with flashing light). Frequency: 3200Hz

MICROLAMP X: intermittent sound F/m 65. Frequency: 3000+/-500Hz

Caractéristiques mécaniques

Base en PC/ABS, dôme en polycarbonate. Fixation par vis standards non fournies.

Caractéristiques optiques

MICROLAMP STEADY (feu fixe), **MICROLAMP STEADY/FLASHING** et **ACOUSTIC** (feu fixe/clignotant) avec ampoule à incandescence Ba15d 5W

MICROLAMP LED et **ACOUSTIC** (feu fixe/clignotant) avec technologie à LED SMD, triple flash 3F

MICROLAMP X et **ACOUSTIC** (feu à éclats) avec tube à décharge au Xénon, simple éclat 1F 1J

Caractéristiques acoustiques

Versions **ACOUSTIC** avec unité piézoélectrique intégrée

MICROLAMP STEADY/FLASHING: son continu (avec lumière fixe) ou son pulsé F/m 130 (avec lumière clignotante). Fréquence: 2700Hz

MICROLAMP LED: son continu (avec lumière fixe) ou son pulsé F/m 180 (avec lumière clignotante). Fréquence: 3200Hz

MICROLAMP X: son pulsé F/m 65. Fréquence: 3000+/-500Hz

Accessori / Accessories / Accessoires



BASE P / P BASE
(Attacco a vite M12)
(M12 single bolt fixing base)
(Fixation M12)



BASE E / E BASE
(Attacco Edison)
(Edison screw base)
(Culot Edison)

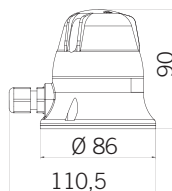
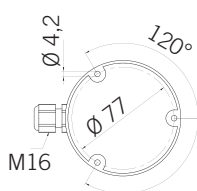

MICROLAMP

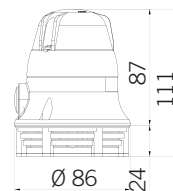

MICROLAMP ACOUSTIC



Codici / Codes

MICROLAMP STEADY*

Luce fissa con lampada a filamento
Steady light with incandescent bulb
Feu fixe, ampoule à incandescence

24/240V ACDC	79782	79783	79784	79785

* Fornito senza lampada / Supplied without bulb / Fourni sans ampoule

MICROLAMP STEADY/FLASHING*

Luce fissa/lampeggiante con lampada a filamento
Steady/flashing light with incandescent bulb
Feu fixe/clignotant avec ampoule à incandescence

12/48V DC	79602	79603	79604	79605
24/240V AC	79612	79613	79614	79615

* Fornito senza lampada / Supplied without bulb / Fourni sans ampoule

MICROLAMP STEADY/FLASHING ACOUSTIC*

Luce fissa/lampeggiante con lampada a filamento + Acustica
Steady/flashing light with incandescent bulb + Acoustics
Feu fixe/clignotant avec ampoule à filament + Acoustique

12V ACDC	79722	79723	79724	79725
24V ACDC	79732	79733	79734	79735
48V ACDC	79742	79743	79744	79745
110V AC	79752	79753	79754	79755
240V AC	79772	79773	79774	79775

* Fornito con lampada / Supplied with bulb / Fourni avec ampoule

MICROLAMP LED

Luce fissa/lampeggiante a LED
LED steady/flashing light
Feu fixe/clignotant à LED

12/24V ACDC	38602	38603	38604	38605
48V ACDC	38612	38613	38614	38615
90/240V AC	38622	38623	38624	38625

MICROLAMP LED ACOUSTIC

Luce fissa/lampeggiante a LED + Acustica
LED steady/flashing light + Acoustics
Feu fixe/clignotant à LED + Acoustique

12/24V ACDC	38632	38633	38634	38635
48V ACDC	38642	38643	38644	38645
90/240V AC	38652	38653	38654	38655

MICROLAMP X*

Luce allo Xenon / Flashing light with Xenon discharge tube
Feu au Xénon

12/24V ACDC	64113	64114	64115	64116
110V AC	64119	64120	64128	64121
240V AC	64123	64124	64125	64126

* Fornito con lampada / Supplied with bulb / Fourni avec ampoule

MICROLAMP X ACOUSTIC*

Luce allo Xenon + Acustica
Flashing light with Xenon discharge tube + Acoustics
Feu au Xénon + Acoustique

12/24V ACDC	91661	91662	91663	91664
110V AC	91673	91674	91675	91676
240V AC	91679	91680	91681	91682

* Fornito con lampada / Supplied with bulb / Fourni avec ampoule

RICAMBI CUPOLE / SPARE DOMES / DOMES DE RECHANGE

71310	71313	71314	71332

ACCESSORI / ACCESSORIES / ACCESSOIRES

P BASE MICROLAMP		83066
E BASE MICROLAMP		83067

CTL 600



CTL 600

CTL 600 ACOUSTIC

68 dB max

Cupole / Domes / Dômes



Base

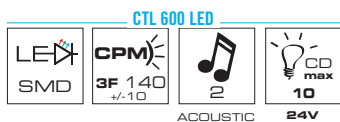
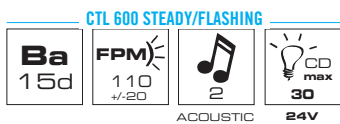
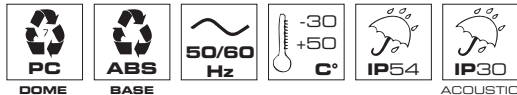

CTL 600 STEADY

V ACDC	12 ÷ 24 ÷ 48 ÷ 110 ÷ 240
mA	415 210 105 45 21

CTL 600 STEADY/FLASHING

V DC	12 ÷ 24 ÷ 48	-	-
V AC	-	24 ÷ 48 ÷ 110 ÷ 240	
mA	425	215	105 45 20

CTL 600 STEADY/FLA. ACOUSTIC

V ACDC	12	24	-
V AC	-	-	240
mA	420	220	25
dB(A)1m	65		

CTL 600 LED

V ACDC	12÷24	-
V AC	-	90÷240
mA	170	30

CTL 600 LED ACOUSTIC

V ACDC	12÷24	-
V AC	-	90÷240
mA	170	30
dB(A)1m	68	

Dispositivo luminoso disponibile in versione:

STEADY e **STEADY/FLASHING** con lampada a incandescenza

LED con tecnologia a LED SMD

L'avvisatore è inoltre disponibile con segnalazione acustica integrata (versioni **ACOUSTIC**).

Tensione operativa

CTL 600 STEADY: 12/240V ACDC +/-10% (fornito senza lampada)

CTL 600 STEADY/FLASHING: 12/48V DC, 24/240V AC +/-10% (fornito senza lampada)

CTL 600 STEADY/FLASHING ACOUSTIC: 12V ACDC, 24V ACDC, 240V AC +/-10% (fornito con lampada)

CTL 600 LED e **ACOUSTIC**: 12/24V ACDC, 90/240V AC +/-10%

Caratteristiche meccaniche

Base in ABS, cupola in policarbonato. Fissaggio tramite viteria standard non fornita.

Caratteristiche luminose

CTL 600 STEADY (luce fissa), **CTL 600 STEADY/FLASHING** e **ACOUSTIC** (luce fissa/lampeggiante) con lampada a incandescenza Ba15d 5W

CTL 600 LED e **ACOUSTIC** (luce fissa/lampeggiante) con tecnologia LED SMD, triplo lampeggio 3F

Caratteristiche acustiche

Versioni **ACOUSTIC** con unità piezoelettrica integrata

CTL 600 STEADY/FLASHING: suono continuo (con luce fissa) o suono intermittente F/m 110 (con luce lampeggiante). Frequenza: 3600Hz

CTL 600 LED: suono continuo (con luce fissa) o suono intermittente F/m 180 (con luce lampeggiante). Frequenza: 3200Hz

Certificazioni / Certifications

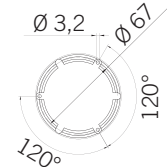
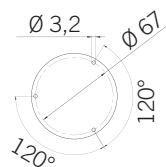
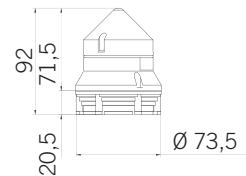
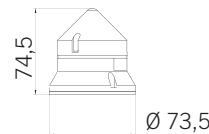

Luminous device available in different versions: **STEADY** and **STEADY/FLASHING** with incandescent lamp **LED** with SMD LED technology. The device is also available with integrated acoustic signaling (**ACOUSTIC** versions).

Voltages

CTL 600 STEADY: 12/240V ACDC +/-10% (supplied without bulb)

CTL 600 STEADY/FLASHING: 12/48V DC, 24/240V AC +/-10% (supplied without bulb)

CTL 600 STEADY/FLASHING ACOUSTIC: 12V ACDC, 24V ACDC, 240V AC +/-10% (supplied with bulb)

CTL 600 LED and **ACOUSTIC**: 12/24V ACDC, 90/240V AC +/-10%

Mechanical features

ABS base, polycarbonate dome. Screw mounting (screws not included).

Optical features

CTL 600 STEADY (steady light), **CTL 600 STEADY/FLASHING** and **ACOUSTIC** (steady/flashing light) with incandescent lamp Ba15d 5W

CTL 600 LED and **ACOUSTIC** (steady/flashing light) with SMD LED technology, triple-flash 3F

Acoustic features

ACOUSTIC versions with integrated piezoelectric unit **CTL 600 STEADY/FLASHING**: continuous sound (with steady light) or intermittent sound F/m 110 (with flashing light). Frequency: 3600Hz

CTL 600 LED: continuous sound (with steady light) or intermittent sound F/m 180 (with flashing light). Frequency: 3200Hz



Feu de signalisation disponible en version : **STEADY** et **STEADY/FLASHING** avec ampoule à incandescence **LED** avec technologie à LED SMD. Le dispositif est également disponible avec un signal acoustique intégré (versions **ACOUSTIC**).

Tension d'utilisation

CTL 600 STEADY: 12/240V ACDC +/-10% (fourni sans ampoule)

CTL 600 STEADY/FLASHING: 12/48V DC, 24/240V AC +/-10% (fourni sans ampoule)

CTL 600 STEADY/FLASHING ACOUSTIC: 12V ACDC, 24V ACDC, 240V AC +/-10% (fourni avec ampoule)

CTL 600 LED et **ACOUSTIC**: 12/24V ACDC, 90/240V AC +/-10%

Caractéristiques mécaniques

Base en ABS, dôme en polycarbonate. Fixation par vis standards non fournies.

Caractéristiques optiques

CTL 600 STEADY (feu fixe), **CTL 600 STEADY/FLASHING** et **ACOUSTIC** (feu fixe/clignotant) avec ampoule à incandescence Ba15d 5W

CTL 600 LED et **ACOUSTIC** (feu fixe/clignotant) avec technologie à LED SMD, triple flash 3F

Caractéristiques acoustiques

Versions **ACOUSTIC** avec unité piézoélectrique intégrée

CTL 600 STEADY/FLASHING: son continu (avec lumière fixe) ou son pulsé F/m 110 (avec lumière clignotante). Fréquence: 3600Hz

CTL 600 LED: son continu (avec lumière fixe) ou son pulsé F/m 180 (avec lumière clignotante). Fréquence: 3200Hz

CTL 900



CTL 900

CTL 900
ACOUSTIC

72 dB max

Cupole / Domes / Dômes



Base

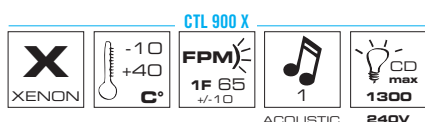
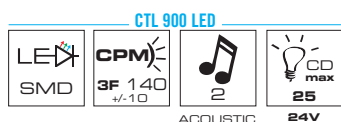
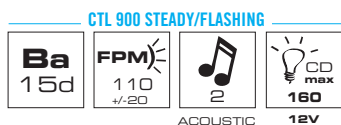
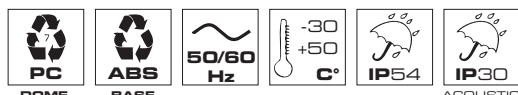

CTL 900 STEADY	
V ACDC	12 ÷ 24 ÷ 48 ÷ 110 ÷ 240
mA	830 415 210 90 42

CTL 900 STEADY/FLASHING	
V DC	12 ÷ 24 ÷ 48 - -
V AC	- 24 ÷ 48 ÷ 110 ÷ 240
mA	850 440 210 90 43

CTL 900 STEADY/FLA ACOUSTIC

V ACDC	12 24 -
V AC	- - 240
mA	850 440 43
dB(A)1m	72

CTL 900 LED		CTL 900 X	
V ACDC	12 ÷ 24 -	V ACDC	12 ÷ 24 -
V AC	- 90 ÷ 240	V AC	- 240
mA	320 75	mA	300 300 30

CTL 900 LED ACOUSTIC		CTL 900 X ACOUSTIC	
V ACDC	12 ÷ 24 -	V ACDC	12 ÷ 24 -
V AC	- 90 ÷ 240	V AC	- 240
mA	320 75	mA	305 305 35
dB(A)1m	72	dB(A)1m	72

Dispositivo luminoso disponibile in versione:

STEADY e **STEADY/FLASHING** con lampada a incandescenza

LED con tecnologia a LED SMD

X a flash con lampada a scarica di Xenon

L'avvisatore è inoltre disponibile con segnalazione acustica integrata (versioni **ACOUSTIC**).

Tensione operativa

CTL 900 STEADY: 12/240V ACDC +/-10% (fornito senza lampada)

CTL 900 STEADY/FLASHING: 12/48V DC, 24/240V AC +/-10% (fornito senza lampada)

CTL 900 STEADY/FLASHING ACOUSTIC: 12V ACDC, 24V ACDC, 240V AC +/-10% (fornito con lampada)

CTL 900 LED e **ACOUSTIC**: 12/24V ACDC, 90/240V AC +/-10%

CTL 900 X e **ACOUSTIC**: 12/24V ACDC, 240V AC +/-10% (fornito con lampada)

Caratteristiche meccaniche

Base in ABS, cupola in policarbonato. Fissaggio tramite viteria standard non fornita.

Caratteristiche luminose

CTL 900 STEADY (luce fissa), **CTL 900 STEADY/FLASHING** e **ACOUSTIC** (luce fissa/lampeggiante) con lampada a incandescenza Ba15d 10W

CTL 900 LED e **ACOUSTIC** (luce fissa/lampeggiante) con tecnologia LED SMD, triplo lampeggio 3F

CTL 900 X e **ACOUSTIC** (luce a flash) con lampada Xenon, flash singolo 1F da 1J

Caratteristiche acustiche

Versioni **ACOUSTIC** con unità piezoelettrica integrata

CTL 900 STEADY/FLASHING: suono continuo (con luce fissa) o suono intermittente F/m 110 (con luce lampeggiante). Frequenza: 2700Hz

CTL 900 LED: suono continuo (con luce fissa) o suono intermittente F/m 160 (con luce lampeggiante). Frequenza: 2700Hz

CTL 900 X: suono intermittente F/m 65. Frequenza: 3800Hz

Certificazioni / Certifications

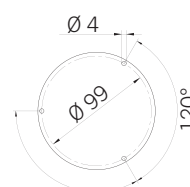
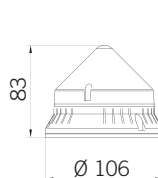

Luminous device available in different versions: **STEADY** and **STEADY/FLASHING** with incandescent lamp
LED with SMD LED technology
X flashing light with Xenon discharge tube

The device is also available with integrated acoustic signaling (**ACOUSTIC** versions).

Voltages

CTL 900 STEADY: 12/240V ACDC +/-10% (supplied without bulb)

CTL 900 STEADY/FLASHING: 12/48V DC, 24/240V AC +/-10% (supplied without bulb)

CTL 900 STEADY/FLASHING ACOUSTIC: 12V ACDC, 24V ACDC, 240V AC +/-10% (supplied with bulb)

CTL 900 LED and **ACOUSTIC**: 12/24V ACDC, 90/240V AC +/-10%

CTL 900 X and **ACOUSTIC**: 12/24V ACDC, 240V AC +/-10% (supplied with bulb)

Mechanical features

ABS base, polycarbonate dome. Screw mounting (screws not included).

Optical features

CTL 900 STEADY (steady light), **CTL 900 STEADY/FLASHING** and **ACOUSTIC** (steady/flashing light) with incandescent lamp Ba15d 10W

CTL 900 LED and **ACOUSTIC** (steady/flashing light) with SMD LED technology, triple-flash 3F

CTL 900 X and **ACOUSTIC** (Xenon flashing light) with 1J Xenon discharge tube, single flash 1F

Acoustic features

ACOUSTIC versions with integrated piezoelectric unit

CTL 900 STEADY/FLASHING: continuous sound (with steady light) or intermittent sound F/m 110 (with flashing light). Frequency: 2700Hz

CTL 900 LED: continuous sound (with steady light) or intermittent sound F/m 160 (with flashing light). Frequency: 2700Hz

CTL 900 X: intermittent sound F/m 65. Frequency: 3800Hz



Feu de signalisation disponible en version : **STEADY** et **STEADY/FLASHING** avec ampoule à incandescence
LED avec technologie à LED SMD
X à éclats, avec tube à décharge au Xénon

Le dispositif est également disponible avec un signal acoustique intégré (versions **ACOUSTIC**).

Tension d'utilisation

CTL 900 STEADY: 12/240V ACDC +/-10% (fourni sans ampoule)

CTL 900 STEADY/FLASHING: 12/48V DC, 24/240V AC +/-10% (fourni sans ampoule)

CTL 900 STEADY/FLASHING ACOUSTIC: 12V ACDC, 24V ACDC, 240V AC +/-10% (fourni avec ampoule)

CTL 900 LED et **ACOUSTIC**: 12/24V ACDC, 90/240V AC +/-10%

CTL 900 X et **ACOUSTIC**: 12/24V ACDC, 240V AC +/-10% (fourni avec ampoule)

Caractéristiques mécaniques

Base en ABS, dôme en polycarbonate. Fixation par vis standards non fournies.

Caractéristiques optiques

CTL 900 STEADY (feu fixe), **CTL 900 STEADY/FLASHING** et **ACOUSTIC** (feu fixe/clignotant) avec ampoule à incandescence Ba15d 10W

CTL 900 LED et **ACOUSTIC** (feu fixe/clignotant) avec technologie à LED SMD, triple flash 3F

CTL 900 X et **ACOUSTIC** (feu à éclats) avec tube à décharge au Xénon, simple éclat 1F 1J

Caractéristiques acoustiques

Versions **ACOUSTIC** avec unité piézoélectrique intégrée

CTL 900 STEADY/FLASHING: son continu (avec lumière fixe) ou son pulsé F/m 110 (avec lumière clignotante). Fréquence: 2700Hz

CTL 900 LED: son continu (avec lumière fixe) ou son pulsé F/m 160 (avec lumière clignotante). Fréquence: 2700Hz

CTL 900 X: son pulsé F/m 65. Fréquence: 3800Hz

CTL 1200

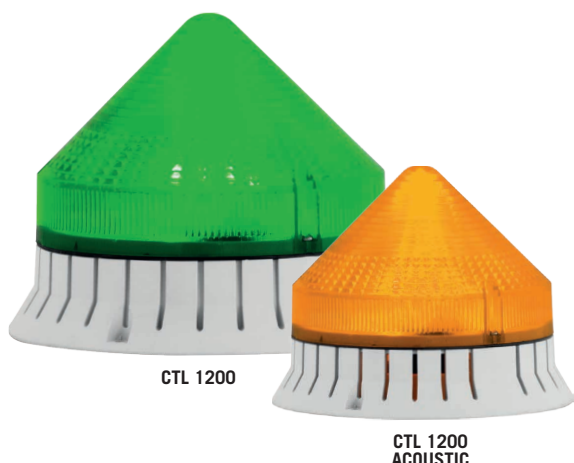

80 dB max

Cupole / Domes / Dômes Base



CTL 1200 LED

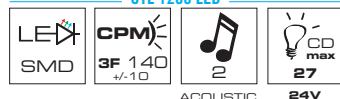

ACOUSTIC

CTL 1200 X

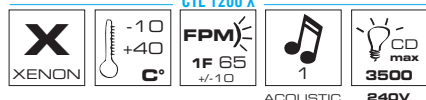

ACOUSTIC

CTL 1200 LED

V ACDC	12 ÷ 24	-	V ACDC	12 ÷ 24	-	-
V AC	-	90 ÷ 240	V AC	-	110	240
mA	320	75	mA	1,0	0,75	0,1

CTL 1200 X

CTL 1200 LED ACOUSTIC

V ACDC	12 ÷ 24	-	V ACDC	12 ÷ 24	-
V AC	-	90 ÷ 240	V AC	-	240
mA	320	75	mA	1,0	0,75
dB(A)1m	74		dB(A)1m	80	72

CTL 1200 X ACOUSTIC

Dispositivo luminoso disponibile in versione:

LED con tecnologia a LED SMD
X a flash con lampada a scarica di Xenon

L'avvisatore è inoltre disponibile con segnalazione acustica integrata (versioni ACOUSTIC).

Tensione operativa

CTL 1200 LED e ACOUSTIC: 12/24V ACDC, 90/240V AC +/-10%
CTL 1200 X: 12/24V ACDC, 110V AC, 240V AC +/-10% (fornito con lampada)
CTL 1200 X ACOUSTIC: 12/24V ACDC, 240V AC +/-10% (fornito con lampada)

Caratteristiche meccaniche

Base in ABS, cupola in policarbonato. Fissaggio tramite viteria standard non fornita.

Caratteristiche luminose

CTL 1200 LED e ACOUSTIC (luce fissa/lampeggiante) con tecnologia LED SMD, triplo lampeggio 3F
CTL 1200 X e ACOUSTIC (luce a flash) con lampada Xenon, potente flash singolo 1F da 6J

Caratteristiche acustiche

Versioni ACOUSTIC con unità piezoelettrica integrata
CTL 1200 LED: suono continuo (con luce fissa) o suono intermittente F/m 160 (con luce lampeggiante). Frequenza: 2700Hz
CTL 1200 X: suono intermittente F/m 65. Frequenza: 3700Hz

Certificazioni / Certifications

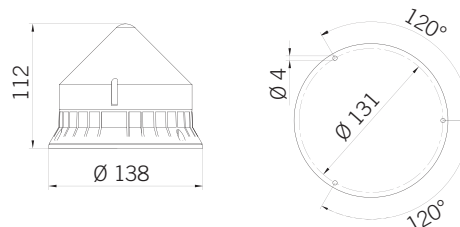

CTL 1200



Luminous device available in different versions:
LED with SMD LED technology
X flashing light with Xenon discharge tube

The device is also available with integrated acoustic signaling (ACOUSTIC versions).

Voltages

CTL 1200 LED and ACOUSTIC: 12/24V ACDC, 90/240V AC +/-10%
CTL 1200 X: 12/24V ACDC, 110V AC, 240V AC +/-10% (supplied with bulb)
CTL 1200 X ACOUSTIC: 12/24V ACDC, 240V AC +/-10% (supplied with bulb)

Mechanical features

ABS base, polycarbonate dome. Screw mounting (screws not included).

Optical features

CTL 1200 LED and ACOUSTIC (steady/flashing light) with SMD LED technology, triple-flash 3F
CTL 1200 X and ACOUSTIC (Xenon flashing light) with powerful 6J Xenon discharge tube, single flash 1F

Acoustic features

ACOUSTIC versions with integrated piezoelectric unit
CTL 1200 LED: continuous sound (with steady light) or intermittent sound F/m 160 (with flashing light). Frequency: 2700Hz
CTL 1200 X: intermittent sound F/m 65. Frequency: 3700Hz



Feu de signalisation disponible en version :
LED avec technologie à LED SMD
X à éclats, avec tube à décharge au Xénon

Le dispositif est également disponible avec un signal acoustique intégré (versions ACOUSTIC).

Tension d'utilisation

CTL 1200 LED et ACOUSTIC : 12/24V ACDC, 90/240V AC +/-10%
CTL 1200 X : 12/24V ACDC, 110V AC, 240V AC +/-10% (fourni avec ampoule)
CTL 1200 X ACOUSTIC : 12/24V ACDC, 240V AC +/-10% (fourni avec ampoule)

Caractéristiques mécaniques

Base en ABS, dôme en polycarbonate. Fixation par vis standards non fournies.

Caractéristiques optiques

CTL 1200 LED et ACOUSTIC (feu fixe/clignotant) avec technologie à LED SMD, triple flash 3F
CTL 1200 X et ACOUSTIC (feu à éclats) avec tube à décharge au Xénon, un puissant simple éclat 1F 6J

Caractéristiques acoustiques

Versions ACOUSTIC avec unité piézoélectrique intégrée
CTL 1200 LED : son continu (avec lumière fixe) ou son pulsé F/m 160 (avec lumière clignotante). Fréquence : 2700Hz
CTL 1200 X : son pulsé F/m 65. Fréquence : 3700Hz

Codici / Codes

CTL STEADY*

Luce fissa con lampada a filamento
Steady light with incandescent bulb
Feu fixe, ampoule à incandescence

	●	●	●	●	●
600 12/240V ACDC	-	33832	33833	33834	33835
900 12/240V ACDC	33841	33842	33843	33844	33845

* Fornito senza lampada / Supplied without bulb / Fourni sans ampoule

CTL STEADY/FLASHING*

Luce fissa/lampeggiante con lampada a filamento
Steady/flashing light with incandescent bulb
Feu fixe/clignotant avec ampoule à incandescence

	●	●	●	●	●
600 12/48V DC	-	33522	33523	33524	33525
24/240V AC	-	33532	33533	33534	33535
900 12/48V DC	33561	33562	33563	33564	33565
24/240V AC	33571	33572	33573	33574	33575

* Fornito senza lampada / Supplied without bulb / Fourni sans ampoule

CTL STEADY/FLASHING ACOUSTIC*

Luce fissa/lampeggiante con lampada a filamento + Acustica
Steady/flashing light with incandescent bulb + Acoustics
Feu fixe/clignotant avec ampoule à incandescence + Acoustique

	●	●	●	●	●
600 12V ACDC	-	33652	33653	33654	33655
24V ACDC	-	33662	33663	33664	33665
240V AC	-	33702	33703	33704	33705
900 12V ACDC	33711	33712	33713	33714	33715
24V ACDC	33721	33722	33723	33724	33725
240V AC	33761	33762	33763	33764	33765

* Fornito con lampada / Supplied with bulb / Fourni avec ampoule

CTL LED

Luce fissa/lampeggiante a LED
LED steady/flashing light
Feu fixe/clignotant à LED

	●	●	●	●	●
600 12/24V ACDC	-	38662	38663	38664	38665
90/240V AC	-	38672	38673	38674	38675
900 12/24V ACDC	38701	38702	38703	38704	38705
90/240V AC	38711	38712	38713	38714	38715
1200 12/24V ACDC	38741	38742	38743	38744	38745
90/240V AC	38751	38752	38753	38754	38755

CTL LED ACOUSTIC

Luce fissa/lampeggiante a LED + Acustica
LED steady/flashing light + Acoustics
Feu fixe/clignotant à LED + Acoustique

	●	●	●	●	●
600 12/24V ACDC	-	38682	38683	38684	38685
90/240V AC	-	38692	38693	38694	38695
900 12/24V ACDC	38721	38722	38723	38724	38725
90/240V AC	38731	38732	38733	38734	38735
1200 12/24V ACDC	38761	38762	38763	38764	38765
90/240V AC	38771	38772	38773	38774	38775

CTL X*

Luce allo Xenon
Flashing light with Xenon discharge tube
Feu au Xénon

	●	●	●	●	●
900 12/24V ACDC	64442	64443	64444	64445	64446
240V AC	64454	64455	64456	64457	64458
1200 12/24V ACDC	64524	64525	64526	64527	64528
110V AC	64530	64531	64532	64533	64534
240V AC	64536	64537	64538	64539	64540

* Fornito con lampada / Supplied with bulb / Fourni avec ampoule

CTL X ACOUSTIC*

Luce allo Xenon + Acustica
Flashing light with Xenon discharge tube + Acoustics
Feu au Xénon + Acoustique

	●	●	●	●	●
900 12/24V ACDC	27566	27567	27568	27569	27570
240V AC	27139	27140	27141	27142	27143
1200 12/24V ACDC	-	27481	27482	27483	27484
240V AC	27492	27493	27494	27495	27496

* Fornito con lampada / Supplied with bulb / Fourni avec ampoule

RICAMBI CUPOLE / SPARE DOMES / DOMES DE RECHANGE

	●	●	●	●	●
600	-	71191	71192	71193	71194
900	71196	71197	71198	71199	71200
1200	71090	71091	71092	71093	71094

OVOLUX RGB



OVOLUX RGB

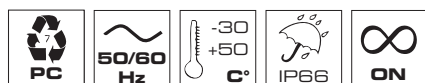

OVOLUX RGB

V ACDC	12 ÷ 24	-
V AC	-	90 ÷ 240
mA	220	40

Codici / Codes

OVOLUX RGB

12/24V ACDC	30107
90/240V AC	30108

RICAMBI CUPOLE / SPARE DOMES / DOMES DE RECHANGE



31302

Dispositivo luminoso multicolore a luce fissa, **OVOLUX RGB** è dotato di circuito elettronico con LED **RGB**, che permette di realizzare 7 colori diversi (bianco, ambra, rosso, giallo, verde, magenta, blu) risultando idoneo per le più diverse applicazioni.

Tensione operativa

12/24V ACDC, 90/240V AC +/-10%

Caratteristiche meccaniche

Base e cupola in opalino realizzate in polycarbonato. Fissaggio tramite anello di chiusura.

Caratteristiche luminose

Luce fissa . 4 LED **RGB** gestiti da circuito elettronico progettato per realizzare i seguenti colori: bianco, ambra, rosso, giallo, verde, magenta, blu.

Certificazioni / Certifications

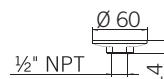
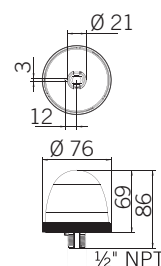

OVOLUX RGB



Steady light multicolor device equipped with electronic circuit with **RGB** LED, **OVOLUX RGB** allows different colors (white, amber, red, yellow, green, magenta, blue) in one beacon, making this device the perfect choice for most applications.

Voltages

12/24V ACDC, 90/240V AC +/-10%

Mechanical features

Polycarbonate dome (opaline) and base. Installation through locking ring.

Optical features

Steady light. 4 **RGB** multicolor LED controlled by an electronic circuit allowing different colors: white, amber, red, yellow, green, magenta, blue.



Feu fixe multicolore pour signalisation machine, **OVOLUX RGB** est équipé d'un circuit électronique avec LED **RGB**, qui permet de piloter 7 couleurs (blanc, orange, rouge, jaune, vert, magenta, bleu) dans un seul feu, ce qui le destine aux applications les plus diverses.

Tension d'utilisation

12/24V ACDC, 90/240V AC +/-10%

Caractéristiques mécaniques

Base et dôme opalin en polycarbonate. Fixation par bague de serrage.

Caractéristiques optiques

Lumière fixe. 4 LED **RGB** gérées par un circuit électronique pour réaliser les couleurs suivantes : blanc, orange, rouge, jaune, vert, magenta, bleu.

OVOLUX



OVOLUX R

OVOLUX M
(con pressacavo M16)
(with M16 cable gland)
(avec presse-étoupe M16)

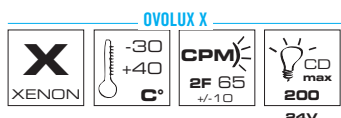
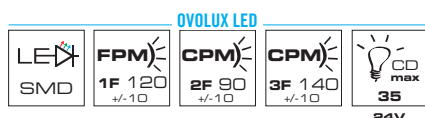
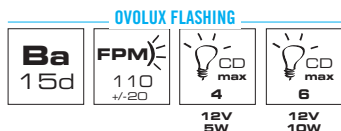
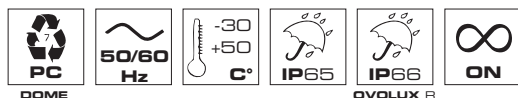

OVOLUX STEADY

V ACDC	12 ÷ 24 ÷ 48 ÷ 110 ÷ 240
mA (5W)	430 210 100 35 22
mA (10W)	830 420 210 90 42

OVOLUX FLASHING

V DC	12 ÷ 24 ÷ 48	-	-
V AC	-	24 ÷ 48 ÷ 110 ÷ 240	
mA (5W)	430	210	100 35 22
mA (10W)	830	420	210 90 42

OVOLUX LED

V ACDC	12 ÷ 24	-
V AC	-	90 ÷ 240
mA	180	40

OVOLUX X

V ACDC	24	-	-
V AC	-	110	240
mA	360	50	65

Dispositivo luminoso disponibile in versione:
STEADY e **FLASHING** con lampada a incandescenza
LED con tecnologia a LED SMD
X a flash con lampada a scarica di Xenon

L'avvisatore è dotato di base per installazione retroquadro (versioni R) o con pressacavo M16 (versioni M).

Tensione operativa

OVOLUX STEADY: 12/240V ACDC +/-10% (fornito senza lampada)

OVOLUX FLASHING: 12/48V DC, 24/240V AC +/-10% (fornito senza lampada)

OVOLUX LED: 12/24V ACDC, 90/240V AC +/-10%

OVOLUX X: 24V ACDC, 110V AC, 240V AC +/-10% (fornito con lampada)

Caratteristiche meccaniche

Cupola e base in policarbonato. Fissaggio tramite anello di chiusura (versioni R), tramite viteria standard non fornita (versioni M).

Caratteristiche luminose

OVOLUX STEADY (luce fissa), **OVOLUX FLASHING** (luce lampeggiante) con lampada a incandescenza Ba15d da 5W o 10W

OVOLUX LED con tecnologia LED SMD, è possibile realizzare 4 diverse funzioni luminose tramite dip-switch (luce fissa, singolo lampeggio, doppio lampeggio, triplo lampeggio)

OVOLUX X con lampada Xenon, doppio flash 2F da 2J

Certificazioni / Certifications

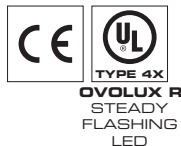

OVOLUX R
STEADY
FLASHING
LED

OVOLUX R

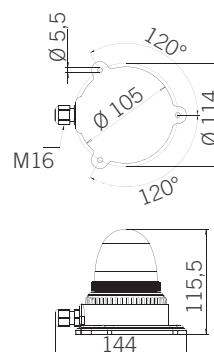
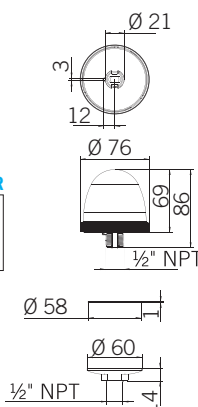

OVOLUX M



Luminous device available in different versions:
STEADY and **FLASHING** with incandescent lamp
LED with SMD LED technology
X flashing light with Xenon discharge tube.

Available with flush mounting base (R versions) or with M16 cable gland (M versions).

Voltages

OVOLUX STEADY: 12/240V ACDC +/-10% (supplied without bulb)

OVOLUX FLASHING: 12/48V DC, 24/240V AC +/-10% (supplied without bulb)

OVOLUX LED: 12/24V ACDC, 90/240V AC +/-10%

OVOLUX X: 24V ACDC, 110V AC, 240V AC +/-10% (supplied with bulb)

Mechanical features

Polycarbonate dome and base. Mounting through the provided locking ring (R versions). Screw mounting (screws not included) for M versions.

Optical features

OVOLUX STEADY (steady light), **OVOLUX FLASHING** (flashing light) with incandescent lamp Ba15d 5W or 10W

OVOLUX LED with SMD LED technology, it is possible to select via dip-switch 4 light effects (steady light, single flash, double flash, triple-flash)

OVOLUX X with 2J Xenon discharge tube, double flash 2F



Feu de signalisation disponible en version :
STEADY et **FLASHING** avec ampoule à incandescence
LED avec technologie à LED SMD
X à éclats, avec tube à décharge au Xénon.

Le dispositif est disponible pour installation à encastrer (versions R) ou avec presse-étoupe M16 (versions M).

Tension d'utilisation

OVOLUX STEADY: 12/240V ACDC +/-10% (fourni sans ampoule)

OVOLUX FLASHING: 12/48V DC, 24/240V AC +/-10% (fourni sans ampoule)

OVOLUX LED: 12/24V ACDC, 90/240V AC +/-10%

OVOLUX X: 24V ACDC, 110V AC, 240V AC +/-10% (fourni avec ampoule)

Caractéristiques mécaniques

Base et dôme en polycarbonate. Fixation par bague de serrage (versions R), ou par vis standards non fournies (versions M).

Caractéristiques optiques

OVOLUX STEADY (feu fixe), **OVOLUX FLASHING** (feu clignotant) avec ampoule à incandescence Ba15d 5W ou 10W

OVOLUX LED avec technologie à LED SMD, on peut sélectionner par dip-switch 4 différents effets lumineux (lumière fixe, simple, double ou triple éclat)

OVOLUX X avec tube à décharge au Xénon, double éclat 2F 2J

Codici / Codes

OVOLUX STEADY*







Luce fissa con lampada a filamento
Steady light with incandescent bulb
Feu fixe, ampoule à incandescence

							
BASES R	12/240V ACDC	30011	30012	30013	30014	30015	30016
M	12/240V ACDC	30031	30032	30033	30034	30035	30036

* Fornito senza lampada / Supplied without bulb / Fourni sans ampoule

OVOLUX FLASHING*







Luce lampeggiante con lampada a filamento
Flashing light with incandescent bulb
Feu clignotant avec ampoule à incandescence

							
BASES R	12/48V DC	30051	30052	30053	30054	30055	30056
	24/240V AC	30091	30092	30093	30094	30095	30096
M	12/48V DC	30071	30072	30073	30074	30075	30076
	24/240V AC	30111	30112	30113	30114	30115	30116

* Fornito senza lampada / Supplied without bulb / Fourni sans ampoule







OVOLUX LED

Luce multifunzione a LED
LED multifunctional light
Feu multifonction à LED

							
BASES R	12/24V ACDC	38781	38782	38783	38784	38785	38786
	90/240V AC	38791	38792	38793	38794	38795	38796
M	12/24V ACDC	38801	38802	38803	38804	38805	38806
	90/240V AC	38811	38812	38813	38814	38815	38816

OVOLUX X*

Luce allo Xenon
Flashing light with Xenon discharge tube
Feu au Xénon

							
BASES R	24V ACDC	30131	30132	30133	30134	30135	30136
	110V AC	30171	30172	30173	30174	30175	30176
	240V AC	30211	30212	30213	30214	30215	30216
M	24V ACDC	30151	30152	30153	30154	30155	30156
	110V AC	30191	30192	30193	30194	30195	30196
	240V AC	30231	30232	30233	30234	30235	30236

* Fornito con lampada / Supplied with bulb / Fourni avec ampoule

RICAMBI CUPOLE / SPARE DOMES / DOMES DE RECHANGE

						
	71115	71116	71117	71098	71099	71100

ACCESSORI / ACCESSORIES / ACCESSOIRES

	
OVOLUX MOUNTING ADAPTER	27697
WALL MOUNT	27762
DOUBLE WALL MOUNT	27763
EXTENDED FOOT L10	27764

ACCESSORI ACCESSORIES ACCESSOIRES



OVOLUX MOUNTING ADAPTER

OVOLUX MOUNTING ADAPTER

ADATTATORE (necessario per utilizzare gli accessori)
ADAPTER (to mount the accessories)
ADAPTATEUR (nécessaire pour utiliser les accessoires)

Codici / Codes

OVOLUX MOUNTING ADAPTER

27697

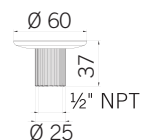

EXTENDED FOOT L10

EXTENDED FOOT L10

Base piana per montaggio superficiale con estensione di 10 cm
Flat base for surface mount with 10 cm extension
Base pour montage à plat (position soulevée de 10 cm)

Codici / Codes

EXTENDED FOOT L10

27764

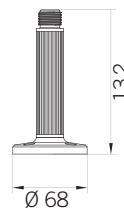

WALL MOUNT

WALL MOUNT

Base parete per montaggio laterale
Wall base for side mount
Support fixation en applique (à filetage simple)

Codici / Codes

WALL MOUNT

27762

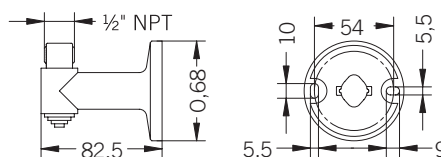

DOUBLE WALL MOUNT

DOUBLE WALL MOUNT

Base parete per montaggio laterale di 2 dispositivi
Wall base for side mount of 2 devices
Support fixation en applique (à double filetage) pour 2 dispositifs

Codici / Codes

DOUBLE WALL MOUNT

27763

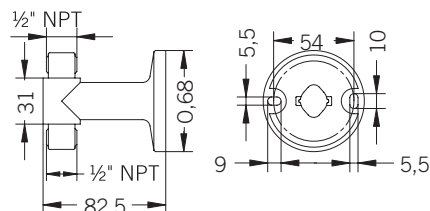

LUCI INDUSTRIALI

Le Luci Industriali rappresentano la gamma più vasta della linea **ELECTRA**.

La quantità dei prodotti e la loro diversificazione (luci rotanti, lampeggianti, Xenon e LED multifunzione) consentono di soddisfare ogni genere di richiesta: dall'applicazione in ambienti industriali e civili all'utilizzo in ambienti heavy duty e navali, per i quali sono state sviluppate luci con base in alluminio (versioni Heavy Duty) e con base stagna in acciaio INOX (versioni Waterproof).

È possibile inoltre incrementare le applicazioni utilizzando gli accessori che consentono il montaggio su base palo o una maggior protezione del prodotto grazie ad apposite griglie.

CARATTERISTICHE DELLA GAMMA

Il grafico mostra la gamma completa delle Luci Industriali a confronto, considerando la larghezza massima di ciascun dispositivo luminoso.

Le famiglie prodotto sono sei:

- **ROTALLARM S LED** (luce a LED con base in plastica), **ROTALLARM HD LED** (luce a LED con base in alluminio), **ROTALLARM WP LED** (luce a LED in versione stagna), **ROTALLARM S** (3 sorgenti di luce con base in plastica), **ROTALLARM HD** (3 sorgenti di luce con base in alluminio)
- **MINIFLASH LED** (con tecnologia FLR e SLR), **MINIFLASH** (disponibile con tre basi di fissaggio)
- **MAXIFLASH LED** (con tecnologia FLR e SLR), **MAXIFLASH** (disponibile con 2 sorgenti di luce)
- **TYPE 200** (disponibile con 2 sorgenti di luce)
- **FAROLAMP LED** (3 effetti di luce), **FAROLAMP X** (luce Xenon con due basi di fissaggio)
- **STR** (disponibile con due basi di fissaggio e 2 sorgenti luminose).



MINIFLASH E MINIFLASH P MINIFLASH S MAXIFLASH S ROTALLARM S ROTALLARM HD

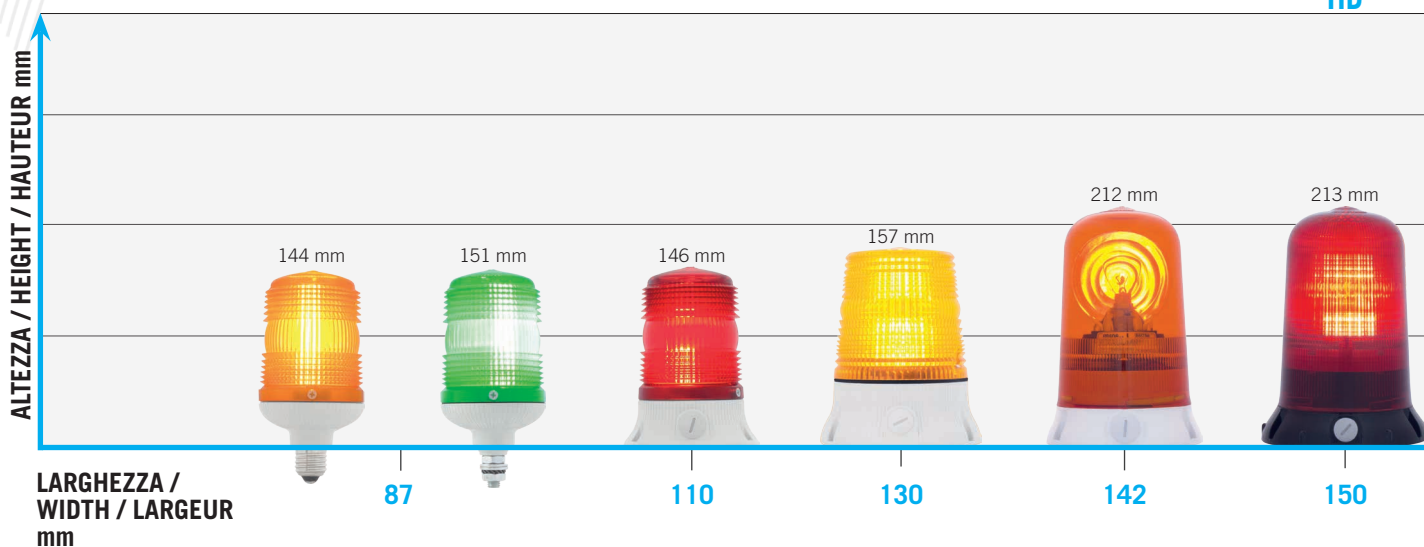



INDUSTRIAL BEACONS

Industrial Beacons represent the widest range of **ELECTRA** products. The number of products and the different options available (rotating, flashing, Xenon flashing and LED multifunction beacons) allow us to satisfy the most demanding requirements, from use in industrial and civil sectors to installation in heavy duty and naval environments. For these latter two sectors we have developed beacons with aluminium base (Heavy Duty versions) and with watertight stainless steel base (Waterproof versions).

The wide range of accessories allows multiple installation possibilities (pole and wall bases) and higher impact resistance thanks to special protection grids.

RANGE FEATURES

The graph shows a comparison of all Industrial Beacons, considering the maximum width of each device.

Six product families belong to this range:

- **ROTALLARM S LED** (LED beacon with thermoplastic base), **ROTALLARM HD LED** (LED beacon with aluminium base), **ROTALLARM WP LED** (LED beacon with watertight stainless steel base), **ROTALLARM S** (3 luminous sources with thermoplastic base), **ROTALLARM HD** (3 luminous sources with aluminium base)
- **MINIFLASH LED** (with FLR and SLR technology), **MINIFLASH** (available with 3 mounting bases)
- **MAXIFLASH LED** (with FLR and SLR technology), **MAXIFLASH** (available with 2 luminous sources)
- **TYPE 200** (available with 2 luminous sources)
- **FAROLAMP LED** (3 light effects), **FAROLAMP X** (Xenon flashing beacon with two mounting bases)
- **STR** (available with two mounting bases and 2 luminous sources).



FEUX INDUSTRIELS

Les Feux Industriels représentent la gamme la plus large de la ligne **ELECTRA**.

Le nombre de produits et leurs diversités (feux tournants, clignotants, Xénon et LED multifonction) peut satisfaire tout type de demande : application dans les environnements industriels et civils, utilisation intensive et marine : pour laquelle ont été développés des feux avec base en aluminium (versions Heavy Duty) et avec base en acier inoxydable (versions Waterproof).

On peut aussi diversifier les applications avec des accessoires qui permettent l'installation sur tube ou une protection mécanique aux chocs plus élevée grâce à une large gamme de grilles spéciales.

CARACTERISTIQUE DE LA GAMME

Le graphique montre la gamme complète des Feux Industriels en comparant la largeur maximale de chaque dispositif lumineux.

Nous vous proposons six familles de produits :

- **ROTALLARM S LED** (feu LED, base en matériel plastique), **ROTALLARM HD LED** (feu LED, base en aluminium), **ROTALLARM WP LED** (feu LED, en version étanche), **ROTALLARM S** (3 sources lumineuses, base en matériel plastique), **ROTALLARM HD** (3 sources lumineuses, base en aluminium) ;
- **MINIFLASH LED** (avec technologie FLR ou SLR), **MINIFLASH** (disponible avec 3 bases de fixation) ;
- **MAXIFLASH LED** (avec technologie FLR ou SLR), **MAXIFLASH** (disponible avec 2 sources lumineuses) ;
- **TYPE 200** (disponible avec 2 sources lumineuses) ;
- **FAROLAMP LED** (3 effets lumineux), **FAROLAMP X** (tube à décharge au Xénon avec deux bases de fixation) ;
- **STR** (disponibles avec deux bases de fixation et deux sources lumineuses).

STR P

ROTALLARM WP LED

STR S

TYPE 200

FAROLAMP P FAROLAMP S

331,5 mm

261 mm

206,5 mm

204 mm

211,5 mm

230 mm

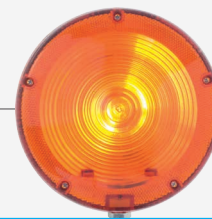

153,5

165

173

190

ROTALLARM S LED



ROTALLARM S LED

Cupole / Domes / Dômes



Base

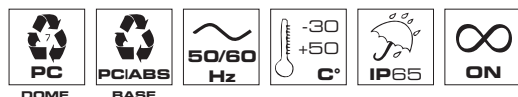

ROTALLARM S LED

V ACDC	12 ÷ 24	-	-
V AC	-	90 ÷ 240	
mA	420	250	80
			55

Accessori / Accessories / Accessoires

GRIGLIA per BASE P
GRID for P BASE
GRILLE pour BASE P

BASE P

Base a palo con attacco Ø 48,5 e due grani di fissaggio

P BASE Base for pole mounted installations (Ø 48,5) with two retaining dowels

BASE P Base hampe Ø 48,5 avec deux vis sans tête

BASE A PARETE
WALL BASE
BASE POUR FIXATION EN APPLIQUE

Luce di segnalazione multifunzione, ROTALLARM S LED è dotato di tecnologia LED SMD che consente tre effetti luminosi con un unico dispositivo. La sua struttura garantisce un'elevata resistenza agli impatti e alle vibrazioni ed un alto grado IP.

Tensione operativa

12/24V ACDC, 90/240V AC +/-10%

Caratteristiche meccaniche

Base in PC/ABS con pressacavo M20, cupola in policarbonato autoestinguente. Fissaggio tramite viteria standard non fornita. Trasmissione assente. Guarnizione in poliuretano sulla base.

Caratteristiche luminose

32x LED 5050 ad alta luminosità producono tre effetti luminosi: luce fissa, rotante e lampeggiante.

Certificazioni / Certifications

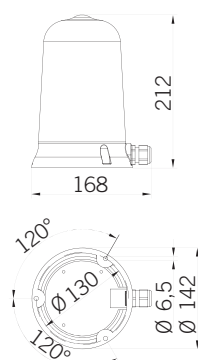

ROTALLARM S LED

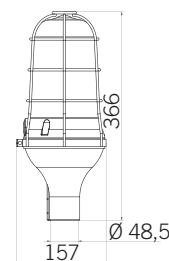
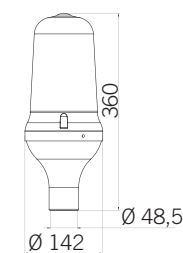
ROTALLARM S LED
+ GRID + P BASEROTALLARM S LED
+ P BASE

Multifunctional beacon ROTALLARM S LED has been developed with SMD LED technology that allows three light effects in one device. The structure guarantees high impact and vibrations resistance as well as high IP grade.

Voltages

12/24V ACDC, 90/240V AC +/-10%

Mechanical features

PC/ABS base with M20 cable gland, self-extinguishing polycarbonate dome. Screw mounting (screws not included). No moving parts. Polyurethane gasket on base.

Optical features

32x 5050 bright LEDs produce three light effects: steady, rotating and flashing light.



Feu de signalisation multifonctionnel avec technologie à LED SMD, ROTALLARM S LED dispose de trois effets lumineux dans un seul feu. Sa structure garantit une haute résistance aux chocs et aux vibrations ainsi que un degré IP élevé.

Tension d'utilisation

12/24V ACDC, 90/240V AC +/-10%

Caractéristiques mécaniques

Base en PC/ABS avec presse-étoupe M20, dôme en polycarbonate autoextinguible. Fixation par vis standards non fournies. Transmission absente. Joint sur la base en polyuréthane.

Caractéristiques optiques

32x LED 5050 à haute luminosité qui produisent trois effets lumineux : lumière fixe, effet tournant, lumière clignotante.

Codici / Codes

ROTALLARM S LED

12/24V ACDC	90061	90062	90063	90064	90065
90/240V AC	90081	90082	90083	90084	90085

RICAMBI CUPOLA / SPARE DOMES / DOMES DE RECHANGE

71301	71300	71303	71304	71330
-------	-------	-------	-------	-------

ACCESSORI / ACCESSORIES / ACCESSOIRES

GRID for P BASE	90883
P BASE for ROTALLARM S LED	83005
WALL BASE	72692

ROTALLARM HD LED



ROTALLARM HD LED

Cupole / Domes / Dômes



Base

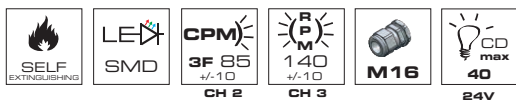
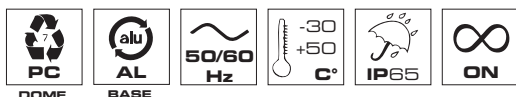

ROTALLARM HD LED

V ACDC	12 ÷ 24	-	-
V AC	-	90 ÷ 240	
mA	420 250	80	55

Accessori / Accessories / Accessoires

GRIGLIA
GRID
GRILLESUPPORTO A PARETE
WALL SUPPORT
SUPPORT POUR FIXATION EN APPLIQUE

Luce di segnalazione dotata di base heavy duty in alluminio. ROTALLARM HD LED è multifunzione, dotato di tecnologia LED SMD che consente tre effetti luminosi con un unico dispositivo. La struttura garantisce un'elevata resistenza agli impatti e alle vibrazioni ed un alto grado IP.

Tensione operativa

12/24V ACDC, 90/240V AC +/-10%

Caratteristiche meccaniche

Base in alluminio con pressacavo M16. Cupola in policarbonato autoestinguente. Fissaggio tramite viteria standard non fornita. Trasmissione assente. Guarnizione in poliuretano sulla base.

Caratteristiche luminose

32x LED 5050 ad alta luminosità producono tre effetti luminosi: luce fissa, rotante e lampeggiante.

Certificazioni / Certifications

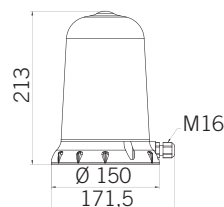
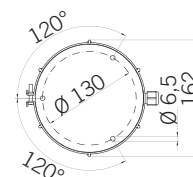
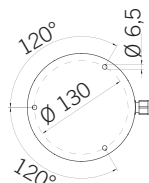

ROTALLARM HD LED

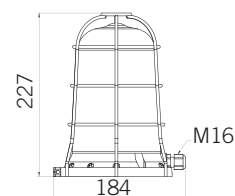
ROTALLARM HD LED
+ GRID

Warning beacon developed with heavy-duty aluminium base. ROTALLARM HD LED is a multifunctional device engineered with SMD LED technology that allows three light effects in one beacon. His structure guarantees high impact and vibrations resistance as well as high IP grade.

Voltages

12/24V ACDC, 90/240V AC +/-10%

Mechanical features

Aluminium base with M16 cable gland. Self-extinguishing polycarbonate dome. Screw mounting (screws not included). No moving parts. Polyurethane gasket on base.

Optical features

32x 5050 bright LEDs produce three light effects: steady, rotating and flashing light.



Feu de signalisation équipé d'une base en aluminium. ROTALLARM HD LED est multifonctionnel, développé avec technologie à LED SMD qui permet trois effets lumineux dans un seul feu. Sa structure garantit une haute résistance aux chocs et aux vibrations ainsi qu'un degré IP élevé.

Tension d'utilisation

12/24V ACDC, 90/240V AC +/-10%

Caractéristiques mécaniques

Base en aluminium avec presse-étoupe M16. Dôme en polycarbonate autoextinguible. Fixation par vis standards non fournies. Transmission absente. Joint sur la base en polyuréthane.

Caractéristiques optiques

32x LED 5050 à haute luminosité qui produisent trois effets lumineux : lumière fixe, effet tournant, lumière clignotante.

Codici / Codes

ROTALLARM HD LED

12/24V ACDC	90181	90182	90183	90184	90185
90/240V AC	90191	90192	90193	90194	90195

RICAMBI CUPOLA / SPARE DOMES / DOMES DE RECHANGE

71301	71300	71303	71304	71330
-------	-------	-------	-------	-------

ACCESSORI / ACCESSORIES / ACCESSOIRES

GRID for HD versions	71690
WALL SUPPORT	71818

ROTALLARM WP LED



ROTALLARM WP LED

Cupole / Domes / Dômes

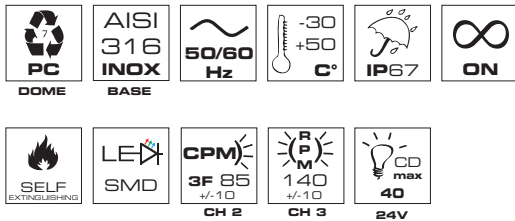

ROTALLARM WP LED

V ACDC	12 ÷ 24	-	-
V AC	-	90 ÷ 240	
mA	420 250	80	55

Luce di segnalazione dotata di base stagna in acciaio inox che le conferisce l'indice di protezione IP67. ROTALLARM WP LED è multifunzione, dotato di tecnologia LED SMD che consente tre effetti luminosi con un unico dispositivo. La struttura garantisce un'elevata resistenza agli impatti e alle vibrazioni.

Tensione operativa

12/24V ACDC, 90/240V AC +/-10%

Caratteristiche meccaniche

Base in acciaio inox con attacco filettato 3/4" G. Cupola in policarbonato autoestinguente. Trasmissione assente.

Caratteristiche luminose

32x LED 5050 ad alta luminosità producono tre effetti luminosi: luce fissa, rotante e lampeggiante.

Certificazioni / Certifications

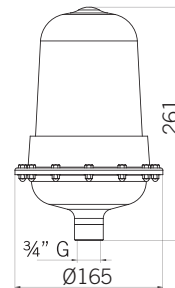

ROTALLARM WP LED



Warning beacon developed with watertight stainless steel base that meets the protection grade IP 67. ROTALLARM WP LED is a multifunctional device engineered with SMD LED technology that allows three light effects in one beacon. His structure guarantees high impact and vibrations resistance.

Voltages

12/24V ACDC, 90/240V AC +/-10%

Mechanical features

Stainless steel base with 3/4" G threaded mount. Self-extinguishing polycarbonate dome. No moving parts.

Optical features

32x 5050 bright LEDs produce three light effects: steady, rotating and flashing light.



Feu de signalisation équipé d'une base étanche en acier inoxydable qui garantit l'indice de protection IP67. ROTALLARM WP LED est multifonctionnel, développé avec technologie à LED SMD qui permet trois effets lumineux dans un seul feu. Sa structure garantit une haute résistance aux chocs et aux vibrations.

Tension d'utilisation

12/24V ACDC, 90/240V AC +/-10%

Caractéristiques mécaniques

Base en acier inoxydable avec fixation fileté 3/4" G. Dôme en polycarbonate autoextinguible. Transmission absente.

Caractéristiques optiques

32x LED 5050 à haute luminosité qui produisent trois effets lumineux : lumière fixe, effet tournant, lumière clignotante.

Codici / Codes

ROTALLARM WP LED

12/24V ACDC	90221	90222	90223	90224	90225
90/240V AC	90231	90232	90233	90234	90235



ROTALLARM S



ROTALLARM S
ROTALLARM S H1

ROTALLARM S STEADY FLASHING
ROTALLARM S FLASHING H1
ROTALLARM S X

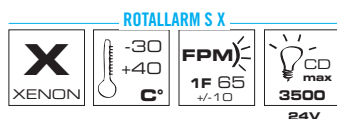
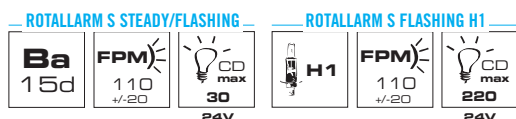
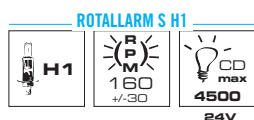
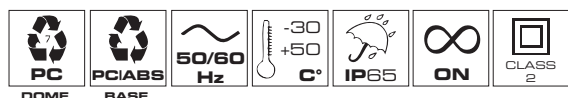

ROTALLARM S				
V ACDC	12	24	-	-
V AC	-	-	110	240
A	4	2,1	0,27	0,20

ROTALLARM S H1		ROTALLARM S STEADY/FLASHING				
V ACDC	12	24	V ACDC	12 ÷ 24 ÷ 48	-	-
A	4,8	3,1	V AC	-	24 ÷ 48 ÷ 110 ÷ 240	
			A	3,4	1,7	0,83

ROTALLARM S FLASHING H1		ROTALLARM S X			
V ACDC	12	24	V ACDC	12 ÷ 24	-
A	4,6	2,9	V AC	-	110
			A	1	0,75

Luce di segnalazione disponibile con tre tecnologie di luce:

S e S STEADY/FLASHING con lampada a incandescenza

S H1 e S FLASHING H1 con lampada alogena H1

S X con lampada a scarica di Xenon

La sua struttura garantisce un'elevata resistenza agli impatti e alle vibrazioni ed un alto grado IP.

Tensione operativa

ROTALLARM S: 12V ACDC, 24V ACDC, 110V AC e 240V AC +/-10% (fornito con lampada)

ROTALLARM S H1: 12V ACDC, 24V ACDC +/-10% (fornito con lampada)

ROTALLARM S STEADY/FLASHING: 12/48V DC, 24/240V AC +/-10% (fornito senza lampada)

ROTALLARM S FLASHING H1: 12V ACDC, 24V ACDC +/-10% (fornito con lampada)

ROTALLARM S X: 12/24V ACDC, 110V AC e 240V AC +/-10% (fornito con lampada)

Caratteristiche meccaniche

Base in PC/ABS con pressacavo M20 e cupola in policarbonato autoestinguento. Fissaggio tramite viteria standard non fornita.

Versioni rotanti ROTALLARM S e S H1: trasmissione meccanica a ingranaggio ad assi paralleli.

Caratteristiche luminose

ROTALLARM S luce rotante con specchio in alluminio anodizzato e lampada BA 15s 45W (12V ACDC e 24V ACDC) oppure lampada E14 25W (110V AC e 240V AC)

ROTALLARM S H1 luce rotante con specchio in alluminio anodizzato e lampada alogena H1 da 55W (12V) o 70W (24V)

ROTALLARM S STEADY/FLASHING luce fissa/lampeggiante con lampada a filamento Ba 15d da 40W

ROTALLARM S FLASHING H1 luce lampeggiante con lampada alogena H1 da 55W (12V) o 70W (24V)

ROTALLARM S X luce a flash con lampada Xenon da 6J, potente flash singolo 1F

Certificazioni / Certifications



Warning beacon available in three different luminous sources:

S and S STEADY/FLASHING with incandescent lamp

S H1 and S FLASHING H1 with halogen bulb

S X with Xenon discharge tube

The structure guarantees high impact and vibrations resistance as well as high IP grade.

Voltages

ROTALLARM S: 12V ACDC, 24V ACDC, 110V AC and 240V AC +/-10% (supplied with bulb)

ROTALLARM S H1: 12V ACDC, 24V ACDC +/-10% (supplied with bulb)

ROTALLARM S STEADY/FLASHING: 12/48V DC, 24/240V AC +/-10% (supplied without bulb)

ROTALLARM S FLASHING H1: 12V ACDC, 24V ACDC +/-10% (supplied with bulb)

ROTALLARM S X: 12/24V ACDC, 110V AC and 240V AC +/-10% (supplied with bulb)

Mechanical features

Self-extinguishing PC/ABS base with M20 cable gland and polycarbonate dome. Screw mounting (screws not included).

Rotating versions ROTALLARM S and S H1: Parallel axis gear drive.

Optical features

ROTALLARM S rotating light with anodized aluminium reflector and BA 15s 45W bulb (12V ACDC and 24V ACDC) or E14 25W bulb (110V AC and 240V AC)

ROTALLARM S H1 rotating light with anodized aluminium reflector and H1 55W (12V) or 70W (24V) halogen bulb

ROTALLARM S STEADY/FLASHING steady/flashing light with 40W Ba 15d incandescent lamp

ROTALLARM S FLASHING H1 flashing light with H1 55W (12V) or 70W (24V) halogen bulb

ROTALLARM S X Xenon flashing light with 6J Xenon discharge tube, high intensity single flash 1F



Feu de signalisation disponible avec trois technologies lumineuses :

S et S STEADY/FLASHING avec ampoule à incandescence

S H1 et S FLASHING H1 avec ampoule halogène H1

S X avec tube à décharge au Xénon

Sa structure garantit une haute résistance aux chocs et aux vibrations ainsi que un degré IP élevé.

Tension d'utilisation

ROTALLARM S : 12V ACDC, 24V ACDC, 110V AC et 240V AC +/-10% (fourni avec ampoule)

ROTALLARM S H1 : 12V ACDC, 24V ACDC +/-10% (fourni avec ampoule)

ROTALLARM S STEADY/FLASHING : 12/48V DC, 24/240V AC +/-10% (fourni sans ampoule)

ROTALLARM S FLASHING H1 : 12V ACDC, 24V ACDC +/-10% (fourni avec ampoule)

ROTALLARM S X : 12/24V ACDC, 110V AC et 240V AC +/-10% (fourni avec ampoule)

Caractéristiques mécaniques

Base en PC/ABS avec presse-étoupe M20 et dôme en polycarbonate autoextinguible. Fixation par vis standards non fournies.

Version tournante ROTALLARM S et S H1 : Entraînement par engrenage à axes parallèles.

Caractéristiques optiques

ROTALLARM S feu tournant avec réflecteur en aluminium anodisé et ampoule BA 15s 45W (12V ACDC et 24V ACDC) ou ampoule E14 25W (110V AC et 240V AC)

ROTALLARM S H1 feu tournant avec réflecteur en aluminium anodisé et ampoule halogène H1 55W (12V) ou 70W (24V)

ROTALLARM S STEADY/FLASHING lumière fixe/clignotante avec ampoule à incandescence Ba 15d 40W

ROTALLARM S FLASHING H1 lumière clignotante avec ampoule halogène H1 55W (12V) ou 70W (24V)

ROTALLARM S X feu à éclats avec tube à décharge au Xénon 6J, puissant flash simple éclat 1F

Accessori / Accessories / Accessoires



GRIGLIA per BASE P
GRID for P BASE
GRILLE pour BASE P



BASE P
Base a palo con attacco Ø 48,5
e due grani di fissaggio
P BASE Base for pole
mounted installations (Ø 48,5)
with two retaining dowels
BASE P Base hampe Ø 48,5
avec deux vis sans tête



BASE A PARETE
WALL BASE
BASE POUR FIXATION EN APPLIQUE

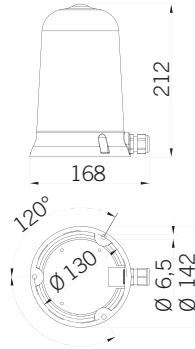

ROTALLARM S

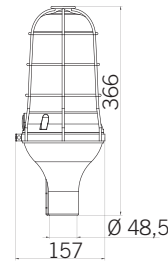

ROTALLARM S
+ GRID + P BASE

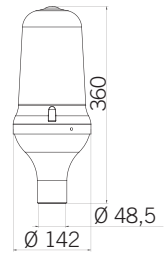

ROTALLARM S
+ P BASE



Codici / Codes

ROTALLARM S*

Luce rotante con lampada a filamento
Rotating beacon with incandescent bulb
Feu tournant avec ampoule à incandescence

12V ACDC	63001	63002	63003	63004	63005
24V ACDC	63013	63014	63015	63016	63017
110V AC	63037	63038	63039	63040	63041
240V AC	63049	63050	63051	63052	63053

* Fornito con lampada / Supplied with bulb / Fourni avec ampoule

ROTALLARM S H1*

Luce rotante con lampada alogena
Rotating beacon with halogen bulb
Feu tournant avec ampoule halogène

12V ACDC	63055	63056	63057	63058	63059
24V ACDC	63066	63067	63068	63069	63070

* Fornito con lampada / Supplied with bulb / Fourni avec ampoule

ROTALLARM S STEADY/FLASHING*

Luce fissa/lampeggiante con lampada a filamento
Steady/flashing light with incandescent bulb
Feu fixe/clignotant avec ampoule à incandescence

12/48V DC	89451	89452	89453	89454	89455
24/240V AC	89461	89462	89463	89464	89465

* Fornito senza lampada / Supplied without bulb / Fourni sans ampoule

ROTALLARM S FLASHING H1*

Luce lampeggiante con lampada alogena
Flashing light with halogen bulb
Feu clignotant avec ampoule halogène

12V ACDC	82401	82402	82403	82404	82405
24V ACDC	82421	82422	82423	82424	82425

* Fornito con lampada / Supplied with bulb / Fourni avec ampoule

ROTALLARM S X*

Luce allo Xenon
Flashing light with Xenon discharge tube
Feu au Xénon

12/24V ACDC	85411	85412	85413	85414	85415
110V AC	85421	85422	85423	85424	85425
240V AC	85431	85432	85433	85434	85435

* Fornito con lampada / Supplied with bulb / Fourni avec ampoule

RICAMBI CUPOLE / SPARE DOMES / DOMES DE RECHANGE

ROTALLARM S / H1	71306	71305	71308	71309	71331
-------------------------	-------	-------	-------	-------	-------

Cupola liscia / Internally smooth / Dôme lisse à l'intérieur

ROTALLARM S STY/FLA / X	71301	71300	71303	71304	71330
--------------------------------	-------	-------	-------	-------	-------

Cupola rigata / Internally fluted / Dôme strié à l'intérieur

ACCESSORI / ACCESSORIES / ACCESSOIRES

GRID for P BASE	90883
P BASE for ROTALLARM S	83005
WALL BASE	72692

ROTALLARM HD



ROTALLARM HD
ROTALLARM HD H1

ROTALLARM HD STEADY FLASHING
ROTALLARM HD FLASHING H1
ROTALLARM HD X

Cupole / Domes / Dômes



Base

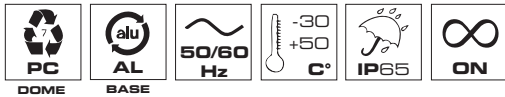

ROTALLARM HD

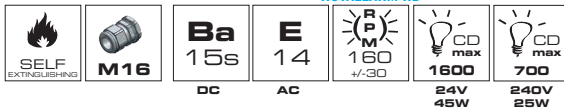

ROTALLARM HD H1

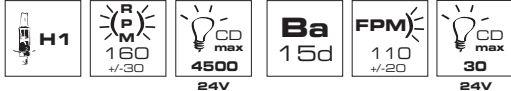

ROTALLARM HD STEADY/FLASHING

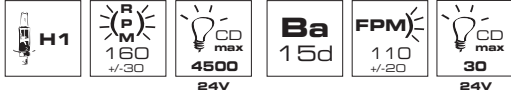

ROTALLARM HD FLASHING H1

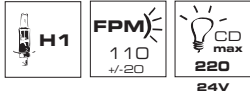

ROTALLARM HD X

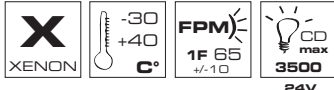

ROTALLARM HD

V ACDC	12	24	-	-
V AC	-	-	110	240
A	4	2,1	0,27	0,20

ROTALLARM HD H1

V ACDC	12	24
A	4,8	3,1

ROTALLARM HD STEADY/FLASHING

V ACDC	12	24	48	-	-
V AC	-	24	48	110	240
A	3,4	1,7	0,83	0,36	0,17

ROTALLARM HD FLASHING H1

V ACDC	12	24
A	4,6	2,9

ROTALLARM HD X

V ACDC	12	24	-	-
V AC	-	-	110	240
A	1	0,75	0,1	0,09

Luce di segnalazione dotata di base heavy duty in alluminio disponibile con tre tecnologie di luce:

HD e **HD STEADY/FLASHING** con lampada a incandescenza

HD H1 e **HD FLASHING H1** con lampada alogena H1

HD X con lampada a scarica di Xenon

La sua struttura garantisce un'elevata resistenza agli impatti e alle vibrazioni ed un alto grado IP.

Tensione operativa

ROTALLARM HD: 12V ACDC, 24V ACDC, 110V AC e 240V AC +/-10% (fornito con lampada)

ROTALLARM HD H1: 12V ACDC, 24V ACDC +/-10% (fornito con lampada)

ROTALLARM HD STEADY/FLASHING: 12/48V DC, 24/240V AC +/-10% (fornito senza lampada)

ROTALLARM HD FLASHING H1: 12V ACDC, 24V ACDC +/-10% (fornito con lampada)

ROTALLARM HD X: 12/24V ACDC, 110V AC e 240V AC +/-10% (fornito con lampada)

Caratteristiche meccaniche

Base in alluminio con pressacavo M16 e cupola in policarbonato autoestinguente. Fissaggio tramite viteria standard non fornita.

Versioni rotanti **ROTALLARM HD** e **HD H1**: trasmissione meccanica a ingranaggio ad assi paralleli.

Caratteristiche luminose

ROTALLARM HD luce rotante con specchio in alluminio anodizzato e lampada BA 15s 45W (12V ACDC e 24V ACDC) oppure lampada E14 25W (110V AC e 240V AC)

ROTALLARM HD H1 luce rotante con specchio in alluminio anodizzato e lampada alogena H1 da 55W (12V) o 70W (24V)

ROTALLARM HD STEADY/FLASHING luce fissa/lampeggiante con lampada a filamento Ba 15d da 40W

ROTALLARM HD FLASHING H1 luce lampeggiante con lampada alogena H1 da 55W (12V) o 70W (24V)

ROTALLARM HD X luce a flash con lampada Xenon da 6J, potente flash singolo 1F

Certificazioni / Certifications



Warning beacon developed with heavy-duty aluminium base available in three different luminous sources:

HD and **HD STEADY/FLASHING** with incandescent lamp

HD H1 and **HD FLASHING H1** with halogen bulb

HD X with Xenon discharge tube

The structure guarantees high impact and vibrations resistance as well as high IP grade.

Voltages

ROTALLARM HD: 12V ACDC, 24V ACDC, 110V AC and 240V AC +/-10% (supplied with bulb)

ROTALLARM HD H1: 12V ACDC, 24V ACDC +/-10% (supplied with bulb)

ROTALLARM HD STEADY/FLASHING: 12/48V DC, 24/240V AC +/-10% (supplied without bulb)

ROTALLARM HD FLASHING H1: 12V ACDC, 24V ACDC +/-10% (supplied with bulb)

ROTALLARM HD X: 12/24V ACDC, 110V AC and 240V AC +/-10% (supplied with bulb)

Mechanical features

Aluminium base with M16 cable gland. Self-extinguishing polycarbonate dome. Screw mounting (screws not included).

Rotating version **ROTALLARM HD** and **HD H1**: parallel axis gear drive.

Optical features

ROTALLARM HD rotating light with anodized aluminium reflector and BA 15s 45W bulb (12V ACDC and 24V ACDC) or E14 25W bulb (110V AC and 240V AC)

ROTALLARM HD H1 rotating light with anodized aluminium reflector and H1 55W (12V) or 70W (24V) halogen bulb

ROTALLARM HD STEADY/FLASHING steady/flashing light with 40W Ba 15d incandescent lamp

ROTALLARM HD FLASHING H1 flashing light with H1 55W (12V) or 70W (24V) halogen bulb

ROTALLARM HD X Xenon flashing light with 6J Xenon discharge tube, high intensity single flash 1F



Feu de signalisation, équipé d'une base en aluminium, disponible avec trois technologies lumineuses :

HD et **HD STEADY/FLASHING** avec ampoule à incandescence

HD H1 et **HD FLASHING H1** avec ampoule halogène H1

HD X avec tube à décharge au Xénon

Sa structure garantit une haute résistance aux chocs et aux vibrations ainsi que un degré IP élevé.

Tension d'utilisation

ROTALLARM HD : 12V ACDC, 24V ACDC, 110V AC et 240V AC +/-10% (fourni avec ampoule)

ROTALLARM HD H1 : 12V ACDC, 24V ACDC +/-10% (fourni avec ampoule)

ROTALLARM HD STEADY/FLASHING : 12/48V DC, 24/240V AC +/-10% (fourni sans ampoule)

ROTALLARM HD FLASHING H1 : 12V ACDC, 24V ACDC +/-10% (fourni avec ampoule)

ROTALLARM HD X : 12/24V ACDC, 110V AC et 240V AC +/-10% (fourni avec ampoule)

Caractéristiques mécaniques

Base en aluminium avec presse-étoupe M16 et dôme en polycarbonate autoextinguible. Fixation par vis standards non fournies.

Version tournante **ROTALLARM HD** et **HD H1** : Entraînement par engrenage à axes parallèles

Caractéristiques optiques

ROTALLARM HD feu tournant avec réflecteur en aluminium anodisé et ampoule BA 15s 45W (12V ACDC et 24V ACDC) ou ampoule E14 25W (110V AC et 240V AC)

ROTALLARM HD H1 feu tournant avec réflecteur en aluminium anodisé et ampoule halogène H1 55W (12V) ou 70W (24V)

ROTALLARM HD STEADY/FLASHING lumière fixe/clignotante avec ampoule à incandescence Ba 15d 40W

ROTALLARM HD FLASHING H1 lumière clignotante avec ampoule halogène H1 55W (12V) ou 70W (24V)

ROTALLARM HD X feu à éclats avec tube à décharge au Xénon 6J, puissant flash simple éclat 1F

Accessori / Accessories / Accessoires



GRIGLIA
GRID
GRILLE



SUPPORTO A PARETE
WALL SUPPORT
SUPPORT POUR FIXATION EN APPLIQUE

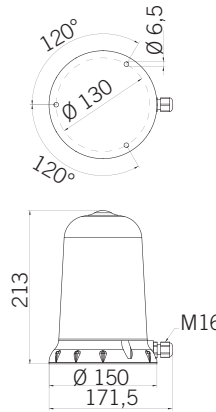

ROTALLARM HD

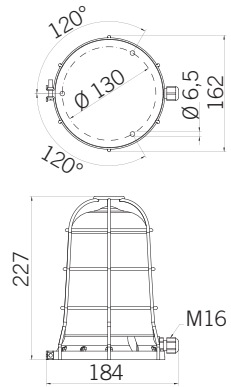

ROTALLARM HD
+ GRID



Codici / Codes

ROTALLARM HD*

Luce rotante con lampada a filamento
Rotating beacon with incandescent bulb
Feu tournant avec ampoule à incandescence

	●	●	●	●	●
12V ACDC	82201	82200	82203	82204	82270
24V ACDC	82211	82210	82213	82214	82271
110V AC	82226	82225	82228	82229	82247
240V AC	82241	82240	82243	82244	82274

* Fornito con lampada / Supplied with bulb / Fourni avec ampoule

ROTALLARM HD H1*

Luce rotante con lampada alogena
Rotating beacon with halogen bulb
Feu tournant avec ampoule halogène

	●	●	●	●	●
12V ACDC	82251	82250	82253	82254	82256
24V ACDC	82261	82260	82263	82264	82273

* Fornito con lampada / Supplied with bulb / Fourni avec ampoule

ROTALLARM HD STEADY/FLASHING*

Luce fissa/lampeggiante con lampada a filamento
Steady/flashing light with incandescent bulb
Feu fixe/clignotant avec ampoule à incandescence

	●	●	●	●	●
12/48V DC	89491	89492	89493	89494	89495
24/240V AC	89511	89512	89513	89514	89515

* Fornito senza lampada / Supplied without bulb / Fourni sans ampoule

ROTALLARM HD FLASHING H1*

Luce lampeggiante con lampada alogena
Flashing light with halogen bulb
Feu clignotant avec ampoule halogène

	●	●	●	●	●
12V ACDC	82441	82442	82443	82444	82445
24V ACDC	82461	82462	82463	82464	82465

* Fornito con lampada / Supplied with bulb / Fourni avec ampoule

ROTALLARM HD X*

Luce allo Xenon
Flashing light with Xenon discharge tube
Feu au Xénon

	●	●	●	●	●
12/24V ACDC	84751	84752	84753	84754	84755
110V AC	84761	84762	84763	84764	84765
240V AC	84771	84772	84773	84774	84775

* Fornito con lampada / Supplied with bulb / Fourni avec ampoule

RICAMBI CUPOLE / SPARE DOMES / DOMES DE RECHANGE

	●	●	●	●	●
ROTALLARM HD / H1	71306	71305	71308	71309	71331

Cupola liscia / Internally smooth / Dôme lisse à l'intérieur

	●	●	●	●	●
ROTALLARM HD STY/FLA / X	71301	71300	71303	71304	71330

Cupola rigata / Internally fluted / Dôme strié à l'intérieur

ACCESSORI / ACCESSORIES / ACCESSOIRES

GRID for HD VERSION	71690
WALL SUPPORT	71818

MINIFLASH LED



MINIFLASH LED FLR S

MINIFLASH LED SLR S

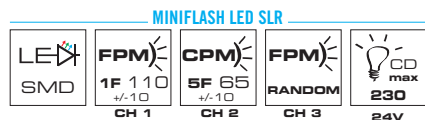
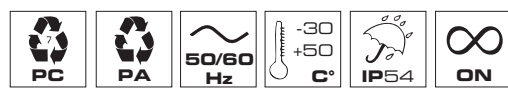

MINIFLASH LED FLR				MINIFLASH LED SLR			
V ACDC	12	24	-	V ACDC	12	24	-
V AC	-	-	90 240	V AC	-	-	90 240
mA	405	255	25 15	mA	375	470	125 85

Accessori / Accessories / Accessoires



BASE A PARETE
WALL BASE
BASE POUR FIXATION EN APPLIQUE

Codici / Codes

MINIFLASH LED FLR

BASES	12/24V ACDC	90/240V AC	Green	Orange	Red	Yellow	White
S	66501	66502	66503	66504	66505	66506	66506
P	66511	66512	66513	66514	66515	66516	66516

MINIFLASH LED SLR S

12/24V ACDC	90/240V AC	Green	Orange	Red	Yellow	White
66541	66542	66543	66544	66545	66546	66546
66551	66552	66553	66554	66555	66556	66556

RICAMBI CUPOLE / SPARE DOMES / DOMES DE RECHANGE

Green	Orange	Red	Yellow	White
71318	71315	71316	71319	71333
71317				

ACCESSORI / ACCESSORIES / ACCESSOIRES

WALL BASE	72692
-----------	-------

Luca a LED multifunzionale di medie dimensioni, sviluppata con tecnologia multicanale. **MINIFLASH LED** è disponibile in versione **FLR** (luce fissa, lampeggiante, rotante) oppure **SLR** (luce lampeggiante, effetto strobo, random).

Tensione operativa

12/24V ACDC, 90/240V AC +/-10%

Caratteristiche meccaniche

Base autoestinguente in poliammide caricato fibra vetro con pressacavo M16 e cupola in policarbonato autoestinguente ad alta resistenza agli impatti. Fissaggio tramite viteria standard non fornita.

Caratteristiche luminose

MINIFLASH LED FLR: 32x LED ad alta luminosità, in configurazione 8x4, producono tre effetti luminosi: luce fissa, lampeggiante (flash singolo 1F), rotante (effetto rotante che simula perfettamente le luci rotanti tradizionali pur non avendo componenti mobili, permettendo quindi di accrescere enormemente il ciclo di vita del prodotto).

MINIFLASH LED SLR: 2x LED SuperBright, consentono tre effetti luminosi: luce lampeggiante (flash singolo 1F), effetto stroboscopico 5F, luce random (effetto unico nel suo genere con lampeggio casuale che consente di aumentare la capacità del dispositivo di attirare l'attenzione).

I diversi effetti luminosi sono gestiti tramite contatti elettrici indipendenti.

La cupola a lente di Fresnel consente di magnificare il fascio luminoso di questi dispositivi.

Certificazioni / Certifications

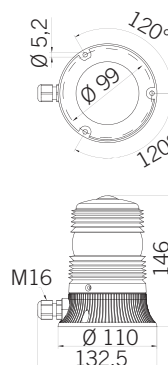

MINIFLASH LED FLR
MINIFLASH LED SLR



Medium size multifunctional LED beacon, developed with a multichannel technology. **MINIFLASH LED** is available in **FLR** (steady, flashing, rotating light) or in **SLR** (flashing, strobe, random light) version.

Voltages

12/24V ACDC, 90/240V AC +/-10%

Mechanical features

High impact resistance self-extinguishing glass reinforced polyamide base with M16 cable gland and polycarbonate dome. Screw mounting (screws not included).

Optical features

MINIFLASH LED FLR: 32x bright LEDs, in a 8x4 configuration, allow three luminous effects: steady light, flashing light (single flash 1F), rotating light (a rotating effect perfectly simulating the traditional rotating beacons yet without moving parts, hence enormously enhancing product life time).

MINIFLASH LED SLR: 2x SuperBright LEDs allow three luminous effects: flashing light (single flash 1F), strobe effect 5F, random light (a unique random effect consisting in an uneven flashing pattern, augmenting the ability of catching attention).

Light effects are controllable via independent electric contacts.

The dome-shaped Fresnel lens intensifies the luminous beam of these devices.



Feu à LED multifonction de taille moyenne, développé sur la base d'une technologie multicanale. **MINIFLASH LED** est disponible en version **FLR** (lumière fixe, clignotante, effet tournant) ou **SLR** (lumière clignotante, effet stroboscopique, effet random).

Tension d'utilisation

12/24V ACDC, 90/240V AC +/-10%

Caractéristiques mécaniques

Base autoextinguible en polyamide renforcé fibre de verre avec presse-étoupe M16 et dôme en polycarbonate autoextinguible à haute résistance aux chocs. Fixation par vis standards non fournies.

Caractéristiques lumineuses

MINIFLASH LED FLR: 32x LED à haute luminosité, en configuration 8x4, produisent trois effets lumineux: lumière fixe, lumière clignotante (simple éclat 1F), tournant (effet tournant qui simule parfaitement les feux tournants traditionnels sans avoir de composants mobiles, permettant ainsi d'augmenter considérablement la durée de vie du produit).

MINIFLASH LED SLR: 2x LED SuperBright, produisent trois effets lumineux: lumière clignotante (simple éclat 1F), effet stroboscopique 5F, effet random (consistant en un clignotement aléatoire, qui permet au dispositif d'augmenter sa capacité d'attirer l'attention).

Les divers effets lumineux sont gérés par connexions électriques indépendantes. Le dôme à lentille de Fresnel permet d'amplifier le faisceau lumineux de ces dispositifs.

MINIFLASH

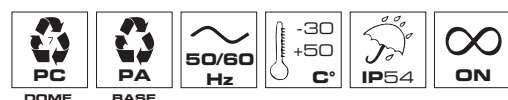

MINIFLASH STEADY					
V ACDC	12 ÷ 24 ÷ 48 ÷ 110 ÷ 240				
A	2,1	1,1	0,52	0,22	0,1

MINIFLASH STEADY/FLASHING					
V AC	12 ÷ 24 ÷ 48	-	-		
V DC	-	24 ÷ 48 ÷ 110 ÷ 240			
A	2,2	1,1	0,52	0,22	0,1

MINIFLASH X			
V ACDC	12 ÷ 24	-	-
V AC	-	110	240
mA	400	350	65
			40

Luce di medie dimensioni disponibile in versione:

STEADY e **STEADY/FLASHING** con lampada a incandescenza

X a flash con lampada a scarica di Xenon

MINIFLASH offre inoltre 3 basi di fissaggio (standard S, a palo P e attacco Edison E).

Tensione operativa

MINIFLASH STEADY: 12/240V ACDC +/-10% (fornito senza lampada)

MINIFLASH STEADY/FLASHING: 12/48V DC, 24/240V AC +/-10% (fornito senza lampada)

MINIFLASH X: 12/24V ACDC, 110V AC, 240V AC +/-10% (fornito con lampada)

Caratteristiche meccaniche

Base autoestingente in poliammide caricato fibra vetro e cupola in polycarbonato autoestingente ad alta resistenza agli impatti. Versioni base S con pressacavo M16 e fissaggio tramite viteria standard non fornita.

Caratteristiche luminose

MINIFLASH STEADY (luce fissa), **MINIFLASH STEADY/FLASHING** (luce fissa/lampeggiante per le basi S e P, luce lampeggiante per la base E) con lampada a incandescenza Ba15d 25W.

MINIFLASH X (luce a flash) con lampada Xenon da 2J, potente flash singolo 1F.

Cupola a lente di Fresnel che consente di magnificare il fascio luminoso.

Certificazioni / Certifications



Medium size beacon available in different versions:

STEADY and **STEADY/FLASHING** with incandescent lamp

X flashing light with Xenon discharge tube

MINIFLASH offers three base versions (standard S, pole mount P and Edison screw base E)

Voltages

MINIFLASH STEADY: 12/240V ACDC +/-10% (supplied without bulb)

MINIFLASH STEADY/FLASHING: 12/48V DC, 24/240V AC +/-10% (supplied without bulb)

MINIFLASH X: 12/24V ACDC, 110V AC, 240V AC +/-10% (supplied with bulb)

Mechanical features

High impact resistance self-extinguishing glass reinforced polyamide base and polycarbonate dome. S base versions with M16 cable gland and screw mounting (screws not included).

Optical features

MINIFLASH STEADY (steady light), **MINIFLASH STEADY/FLASHING** (steady/flashing light for S and P bases, flashing light for E base) with incandescent lamp Ba15d 25W.

MINIFLASH X (Xenon flashing light) with 2J Xenon discharge tube, strong single flash 1F.

The dome-shaped Fresnel lens intensifies the beam of light.



Feu de taille moyenne disponible en version :

STEADY et **STEADY/FLASHING** avec ampoule à incandescence

X à éclats, avec tube à décharge au Xénon

MINIFLASH offre trois bases de fixation (standard S, hampe P et culot Edison E)

Tension d'utilisation

MINIFLASH STEADY : 12/240V ACDC +/-10% (fourni sans ampoule)

MINIFLASH STEADY/FLASHING : 12/48V DC, 24/240V AC +/-10% (fourni sans ampoule)

MINIFLASH X : 12/24V ACDC, 110V AC, 240V AC +/-10% (fourni avec ampoule)

Caractéristiques mécaniques

Base autoextinguible en polyamide renforcé fibre de verre et dôme en polycarbonate autoextinguible à haute résistance aux chocs. Versions base S avec presse-étoupe M16 et fixation par vis standards non fournies.

Caractéristiques optiques

MINIFLASH STEADY (feu fixe), **MINIFLASH STEADY/FLASHING** (feu fixe/clignotant pour les bases S et P, feu clignotant pour la base E) avec ampoule à incandescence Ba15d 25W.

MINIFLASH X (feu à éclats) avec tube à décharge au Xénon 2J, un puissant simple éclat 1F.

Dôme à lentille de Fresnel qui permet d'augmenter le faisceau lumineux.

Accessori / Accessories / Accessoires



BASE A PARETE
WALL BASE
BASE POUR FIXATION EN APPLIQUE

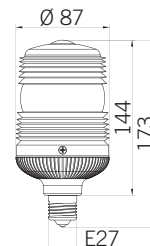
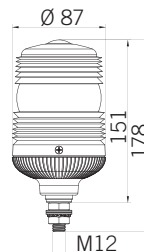
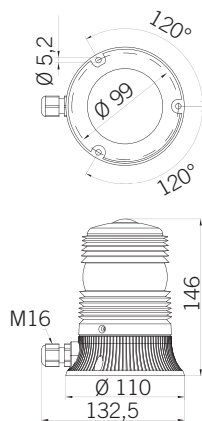

MINIFLASH S



MINIFLASH P



MINIFLASH E



Codici / Codes

MINIFLASH STEADY*

Luce fissa con lampada a filamento
Steady light with incandescent bulb
Feu fixe, ampoule à incandescence

BASES							
S	12/240V ACDC	89111	89112	89113	89114	89115	89116
P	12/240V ACDC	89131	89132	89133	89134	89135	89136
E	12/240V ACDC	89151	89152	89153	89154	89155	89156

* Fornito senza lampada / Supplied without bulb / Fourni sans ampoule

MINIFLASH STEADY/FLASHING*

Luce fissa/lampeggiante con lampada a filamento
Steady/flashing light with incandescent bulb
Feu fixe/clignotant avec ampoule à incandescence

BASES							
S	12/48V DC	89171	89172	89173	89174	89175	89176
	24/240V AC	89181	89182	89183	89184	89185	89186
P	12/48V DC	89211	89212	89213	89214	89215	89216
	24/240V AC	89221	89222	89223	89224	89225	89226
E	12/48V DC	89611	89612	89613	89614	89615	89616
	24/240V AC	89251	89252	89253	89254	89255	89256

* Fornito senza lampada / Supplied without bulb / Fourni sans ampoule

MINIFLASH X*

Luce allo Xenon
Flashing light with Xenon discharge tube
Feu au Xénon

BASES							
S	12/24V ACDC	63753	63754	63755	63756	63757	63758
	110V AC	63759	63760	63761	63762	63763	63764
	240V AC	63765	63766	63767	63768	63769	63770
P	12/24V ACDC	63788	63789	63790	63750	63791	63792
	110V AC	63793	63794	63795	63796	63797	63798
	240V AC	63799	63800	63801	63802	63803	63804
E	12/24V ACDC	63817	63818	63819	89617	63820	89618
	110V AC	63821	63822	63823	63824	63825	63826
	240V AC	63827	63828	63829	63830	63831	63832

* Fornito con lampada / Supplied with bulb / Fourni avec ampoule

RICAMBI CUPOLE / SPARE DOMES / DOMES DE RECHANGE

	71318	71315	71316	71319	71333	71317

ACCESSORI / ACCESSORIES / ACCESSOIRES

WALL BASE	72692
-----------	-------

MAXIFLASH LED



MAXIFLASH LED FLR S

MAXIFLASH LED SLR S

Cupole / Domes / Dômes



Base

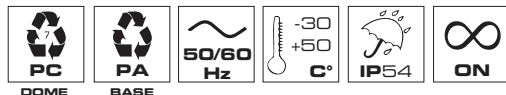

MAXIFLASH LED FLR

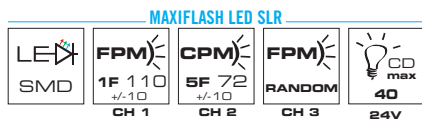

MAXIFLASH LED SLR

MAXIFLASH LED FLR				MAXIFLASH LED SLR			
V ACDC	12 ÷ 24	-	-	V ACDC	12 ÷ 24	-	-
V AC	-	90 ÷ 240		V AC	-	90 ÷ 240	
mA	450	250	70	40	mA	250	550
						70	80

Accessori / Accessories / Accessoires



BASE A PARETE
WALL BASE
BASE POUR FIXATION EN APPLIQUE

Codici / Codes

MAXIFLASH LED FLR S

12/24V ACDC	43002	43003	43004	43005
90/240V AC	43012	43013	43014	43015

MAXIFLASH LED SLR S

12/24V ACDC	43042	43043	43044	43045
90/240V AC	43052	43053	43054	43055

RICAMBI CUPOLE / SPARE DOMES / DOMES DE RECHANGE

71320	71323	71324	71334
-------	-------	-------	-------

ACCESSORI / ACCESSORIES / ACCESSOIRES

WALL BASE	72692
-----------	-------

Luce a LED multifunzionale sviluppata con tecnologia multicanale. **MAXIFLASH LED** è disponibile in versione **FLR** (luce fissa, lampeggiante, rotante) oppure **SLR** (luce lampeggiante, effetto strobo, random).

Tensione operativa

12/24V ACDC, 90/240V AC +/-10%

Caratteristiche meccaniche

Base autoestinguente in poliammide caricato fibra vetro con pressacavo M16 e cupola in policarbonato autoestinguente ad alta resistenza agli impatti. Fissaggio tramite viteria standard non fornita.

Caratteristiche luminose

MAXIFLASH LED FLR: 32x LED ad alta luminosità, in configurazione 8x4, producono tre effetti luminosi: luce fissa, lampeggiante (flash singolo 1F), rotante (effetto rotante che simula perfettamente le luci rotanti tradizionali pur non avendo componenti mobili, permettendo quindi di accrescere enormemente il ciclo di vita del prodotto).

MAXIFLASH LED SLR: 2x LED SuperBright, consentono tre effetti luminosi: luce lampeggiante (flash singolo 1F), effetto stroboscopico 5F, luce random (effetto unico nel suo genere con lampeggio casuale che consente di aumentare la capacità del dispositivo di attirare l'attenzione).

I diversi effetti luminosi sono gestiti tramite contatti elettrici indipendenti.

La cupola a lente di Fresnel consente di magnificare il fascio luminoso di questi dispositivi.

Certificazioni / Certifications

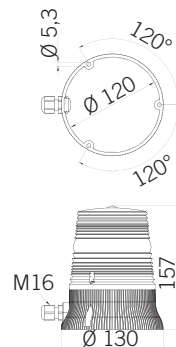

MAXIFLASH LED FLR
MAXIFLASH LED SLR



Multifunctional LED beacon, developed with a multichannel technology. **MAXIFLASH LED** is available in **FLR** (steady, flashing, rotating light) or in **SLR** (flashing, strobe, random light) version.

Voltages

12/24V ACDC, 90/240V AC +/-10%

Mechanical features

High impact resistance self-extinguishing glass reinforced polyamide base (with M16 cable gland) and polycarbonate dome. Screw mounting (screws not included).

Optical features

MAXIFLASH LED FLR: 32x bright LEDs, in a 8x4 configuration, allow three luminous effects: steady light, flashing light (single flash 1F), rotating light (a rotating effect perfectly simulating the traditional rotating beacons yet without moving parts, hence enormously enhancing product life time).

MAXIFLASH LED SLR: 2x SuperBright LEDs allow three luminous effects: flashing light (single flash 1F), strobe effect 5F, random light (a unique random effect consisting in an uneven flashing pattern, augmenting the ability of catching attention).

Light effects are controllable via independent electric contacts.

The dome-shaped Fresnel lens intensifies the luminous beam of these devices.



Feu à LED multifonction développé sur la base d'une technologie multicanale. **MAXIFLASH LED** est disponible en version **FLR** (lumière fixe, clignotante, effet tournant) ou **SLR** (lumière clignotante, effet stroboscopique, effet random).

Tension d'utilisation

12/24V ACDC, 90/240V AC +/-10%

Caractéristiques mécaniques

Base autoextinguible en polyamide renforcé fibre de verre avec presse-étoupe M16 et dôme en polycarbonate autoextinguible à haute résistance aux chocs. Fixation par vis standards non fournies.

Caractéristiques optiques

MAXIFLASH LED FLR : 32x LED à haute luminosité, en configuration 8x4, produisent trois effets lumineux : lumière fixe, lumière clignotante (simple éclat 1F), tournant (effet tournant qui simule parfaitement les feux tournants traditionnels sans avoir de composants mobiles, permettant ainsi d'augmenter considérablement la durée de vie du produit).

MAXIFLASH LED SLR : 2x LED SuperBright, produisent trois effets lumineux : lumière clignotante (simple éclat 1F), effet stroboscopique 5F, effet random (consistant en un clignotement aléatoire, qui permet au dispositif d'augmenter sa capacité d'attirer l'attention).

Les divers effets lumineux sont gérés par connexions électriques indépendantes. Le dôme à lentille de Fresnel permet d'amplifier le faisceau lumineux de ces dispositifs.

MAXIFLASH



MAXIFLASH S

Cupole / Domes / Dômes



Base

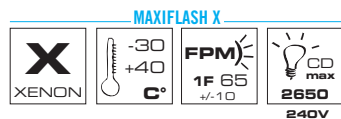
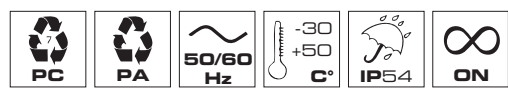

MAXIFLASH STEADY

V ACDC	12 ÷ 24 ÷ 48 ÷ 110 ÷ 240
A (25W)	2,1 1,1 0,52 0,22 0,1
A (40W)	3,3 1,65 0,83 0,36 0,17

MAXIFLASH STEADY/FLASHING

V DC	12 ÷ 24 ÷ 48	-	-
V AC	-	24 ÷ 48 ÷ 110 ÷ 240	
A (25W)	2,2	1,1	0,52 0,22 0,1
A (40W)	3,4	1,7	0,83 0,36 0,17

MAXIFLASH X

V ACDC	12 ÷ 24	-	-
V AC	-	110	240
A	1	0,75	0,1 0,09

Accessori / Accessories / Accessoires



BASE A PARETE
WALL BASE
BASE POUR FIXATION EN APPLIQUE

Luce di medie dimensioni disponibile in versione:
STEADY e STEADY/FLASHING con lampada a incandescenza
X a flash con lampada a scarica di Xenon.

Tensione operativa

MAXIFLASH STEADY: 12/240V ACDC +/-10% (fornito senza lampada)

MAXIFLASH STEADY/FLASHING: 12/48V DC, 24/240V AC +/-10% (fornito senza lampada)

MAXIFLASH X: 12/24V ACDC, 110V AC, 240V AC +/-10% (fornito con lampada)

Caratteristiche meccaniche

Base autoestinguente con pressacavo M16 in poliammide caricato fibra vetro e cupola in policarbonato autoestinguente ad alta resistenza agli impatti. Fissaggio tramite viteria standard non fornita.

Caratteristiche luminose

MAXIFLASH STEADY (luce fissa), MAXIFLASH STEADY/FLASHING (luce fissa/lampeggiante) con lampada a incandescenza Ba15d 25W o 40W.

MAXIFLASH X (luce a flash) con lampada Xenon da 6J, potente flash singolo 1F.

Cupola a lente di Fresnel che consente di magnificare il fascio luminoso.

Certificazioni / Certifications

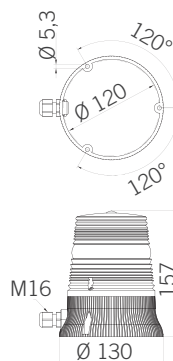

MAXIFLASH S



Medium size beacon available in different versions:
STEADY and STEADY/FLASHING with incandescent lamp
X flashing light with Xenon discharge tube.

Voltages

MAXIFLASH STEADY: 12/240V ACDC +/-10% (supplied without bulb)

MAXIFLASH STEADY/FLASHING: 12/48V DC, 24/240V AC +/-10% (supplied without bulb)

MAXIFLASH X: 12/24V ACDC, 110V AC, 240V AC +/-10% (supplied with bulb)

Mechanical features

High impact resistance self-extinguishing glass reinforced polyamide base with M16 cable gland and polycarbonate dome. Screw mounting (screws not included).

Optical features

MAXIFLASH STEADY (steady light), MAXIFLASH STEADY/FLASHING (steady/flashing light) with incandescent lamp Ba15d 25W or 40W.

MAXIFLASH X (Xenon flashing light) with 6J Xenon discharge tube, strong single flash 1F.

The dome-shaped Fresnel lens intensifies the beam of light.



Feu de taille moyenne disponible en version :
STEADY et STEADY/FLASHING avec ampoule à incandescence
X à éclats, avec tube à décharge au Xénon.

Tension d'utilisation

MAXIFLASH STEADY : 12/240V ACDC +/-10% (fourni sans ampoule)

MAXIFLASH STEADY/FLASHING : 12/48V DC, 24/240V AC +/-10% (fourni sans ampoule)

MAXIFLASH X : 12/24V ACDC, 110V AC, 240V AC +/-10% (fourni avec ampoule)

Caractéristiques mécaniques

Base autoextinguible avec presse-étoupe M16 en polyamide renforcé fibre de verre et dôme en polycarbonate à haute résistance aux chocs. Fixation par vis standards non fournies.

Caractéristiques optiques

MAXIFLASH STEADY (feu fixe), MAXIFLASH STEADY/FLASHING (feu fixe/clignotante) avec ampoule à incandescence Ba15d 25W ou 40W.

MAXIFLASH X (feu à éclats) avec tube à décharge au Xénon 6J, un puissant simple éclat 1F.

Dôme à lentille de Fresnel qui permet d'augmenter le faisceau lumineux.

Codici / Codes

MAXIFLASH STEADY S* Luce fissa con lampada a filamento
Steady light with incandescent bulb / Feu fixe, ampoule à incandescence

12/240V ACDC 89272 89273 89274 89275

* Fornito senza lampada / Supplied without bulb / Fourni sans ampoule

MAXIFLASH STEADY/FLASHING S* Luce fissa/lampeggiante con lampada a filamento
Steady/flashing light with incandescent bulb / Feu fixe/clignotant avec ampoule à filament

12/48V DC 89332 89333 89334 89335
24/240V AC 89342 89343 89344 89345

* Fornito senza lampada / Supplied without bulb / Fourni sans ampoule

MAXIFLASH X S* Luce allo Xenon / Xenon flashing light / Feu au Xénon

12/24V ACDC 63866 63867 63868 63869
110V AC 63872 63873 63874 63875
240V AC 63878 63879 63880 63881

* Fornito con lampada / Supplied with bulb / Fourni avec ampoule

RICAMBI CUPOLE / SPARE DOMES / DOMES DE RECHANGE

71320 71323 71324 71334

ACCESSORI / ACCESSORIES / ACCESSOIRES

WALL BASE 72692

TYPE 200



TYPE 200 H1

TYPE 200 LED

Cupole / Domes / Dômes



Base

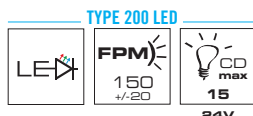

	TYPE 200 H1				TYPE 200 LED			
V ACDC	12	24	-	-	V ACDC	24	-	-
V AC	-	-	110	240	V AC	-	110	240
A	4,8	3,1	0,5	0,22	mA	180	40	40

Accessori / Accessories / Accessoires



BASE A PARETE
WALL BASE
BASE POUR FIXATION EN APPLIQUE

Codici / Codes

TYPE 200 H1* *Luce rotante con lampada alogena*

Rotating beacon with halogen bulb / Feu tournant avec ampoule halogène

	Orange	Red	Green	Yellow
12V ACDC	26352	26353	26354	26355
24V ACDC	26362	26363	26364	26365
110V AC	26382	26383	26384	26385
240V AC	26392	26393	26394	26395

* Fornito con lampada / Supplied with bulb / Fourni avec ampoule

TYPE 200 LED* *Luce fissa/lampeggiante a LED*

LED Steady/flashing light / Feu fixe/clignotant à LED

	Orange	Red	Green	Yellow
24V ACDC	26252	26253	26254	26255
110V AC	26272	26273	26274	26275
240V AC	26282	26283	26284	26285

* Fornito con lampada / Supplied with bulb / Fourni avec ampoule

RICAMBI CUPOLE / SPARE DOMES / DOMES DE RECHANGE

	Orange	Red	Green	Yellow
	71167	71168	71169	71172

ACCESSORI / ACCESSORIES / ACCESSOIRES

WALL BASE	72692
-----------	-------

Luce progettata per applicazioni ad uso gravoso, disponibile con due tecnologie di luce:

H1 con lampada alogena H1

LED con tecnologia LED (5 mm)

La sua struttura garantisce un'elevata durabilità del prodotto, la versione LED incrementa ulteriormente questa caratteristica offrendo un prodotto virtualmente a manutenzione zero.

Tensione operativa

TYPE 200 H1: 12V ACDC, 24V ACDC, 110V AC e 240V AC +/-10% (fornito con lampada)

TYPE 200 LED: 24V ACDC, 110V AC e 240V AC +/-10%

Caratteristiche meccaniche

Base in poliammide caricato fibra di vetro con pressacavo M20 e cupola in policarbonato autoestinguente. Fissaggio tramite viteria standard non fornita.

Trasmissione meccanica a ingranaggio con vite senza fine (versione H1).

Caratteristiche luminose

TYPE 200 H1 (luce rotante) con specchio parabolico rotante cromato e lampada alogena H1 da 55W (12V) o 70W (24V)

TYPE 200 LED (luce fissa/lampeggiante) con 45 led colorati da 5 mm e lente di Fresnel interna per una perfetta intensità di colore

Certificazioni / Certifications

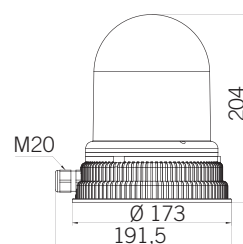
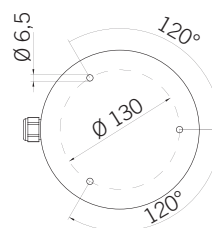

TYPE 200



Warning beacon designed for heavy-duty applications, available with two different luminous sources:

H1 with halogen bulb

LED with LED technology (5 mm)

Its unique structure guarantees the best durability of the product; the LED version extends even further the life of the product delivering a virtually maintenance-free device.

Voltages

TYPE 200 H1: 12V ACDC, 24V ACDC, 110V AC and 240V AC +/-10% (supplied with bulb)

TYPE 200 LED: 24V ACDC, 110V AC and 240V AC +/-10%

Mechanical features

Self-extinguishing glass reinforced polyamide base with M20 cable gland, self-extinguishing polycarbonate dome. Screw mounting (screws not included).

Worm gear drive (H1 version).

Optical features

TYPE 200 H1 (rotating light) with chromed metal parabolic reflector with H1 55W (12V) or 70W (24V) halogen bulb

TYPE 200 LED (steady/flashing light) with 45 x 5 mm colored LEDs and inner Fresnel lens that provide a perfect color intensity output.



Feu conçu pour une utilisation intensive, disponible avec deux technologies lumineuses :

H1 avec ampoule halogène

LED avec technologie LED (5 mm)

Sa structure garantit une haute durabilité du produit, la version à LED favorise cette caractéristique, en offrant un produit à entretien quasi-nul.

Tension d'utilisation

TYPE 200 H1 : 12V ACDC, 24V ACDC, 110V AC et 240V AC +/-10% (fourni avec ampoule)

TYPE 200 LED : 24V ACDC, 110V AC et 240V AC +/-10%

Caractéristiques mécaniques

Base autoextinguible en polyamide renforcé fibre de verre avec presse-étoupe M20 et dôme en polycarbonate autoextinguible. Fixation par vis standards non fournies

Entraînement par engrenage à vis sans fin (version H1).

Caractéristiques optiques

TYPE 200 H1 (feu tournant) avec réflecteur tournant chromé et ampoule halogène H1 55W (12V) ou 70W (24V)

TYPE 200 LED (lumière fixe/clignotante) avec 45 LED colorées de 5 mm et lentille de Fresnel qui garantissent l'intensité des couleurs.

FAROLAMP LED



FAROLAMP LED S

FAROLAMP LED P

Cupole / Domes / Dômes



Base



FAROLAMP LED

V ACDC	12 ÷ 24
mA	450 700

Codici / Codes

FAROLAMP LED

BASES					
S	12/24V ACDC	85092	85093	85094	85095
P	12/24V ACDC	85225	85226	85227	85228

RICAMBI CUPOLE / SPARE DOMES / DOMES DE RECHANGE

	71325	71328	71329	71293

Luce a LED multifunzionale, sviluppata con tecnologia multicanale. FAROLAMP LED dispone di 3 effetti luce: luce lampeggiante, effetto strobo, random. Disponibile con due basi di fissaggio (standard S e a palo P).

Tensione operativa

12/24V ACDC +/-10%

Caratteristiche meccaniche

Base in acciaio ad alta resistenza agli impatti e fissaggio tramite viteria standard non fornita (versione base S). Cupola in policarbonato autoestinguente.

Caratteristiche luminose

2x LED SuperBright, consentono tre effetti luminosi: luce lampeggiante (flash singolo 1F), effetto stroboscopico 5F, luce random (effetto unico nel suo genere con lampeggio casuale che consente di aumentare la capacità del dispositivo di attirare l'attenzione).

I diversi effetti luminosi sono gestiti tramite contatti elettrici indipendenti.

La cupola a lente di Fresnel consente di magnificare il fascio luminoso di questi dispositivi.

Certificazioni / Certifications

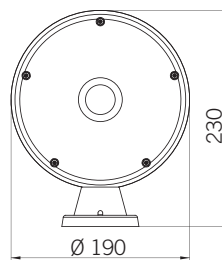
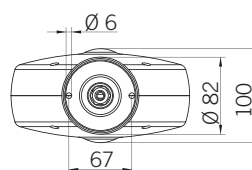

FAROLAMP LED S

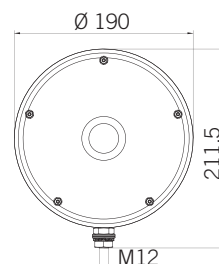

FAROLAMP LED P



Multifunctional LED beacon, developed with a multichannel technology. FAROLAMP LED allows three separate light effects: flashing, strobe and random.

Two bases available (standard S and pole mount P).

Voltages

12/24V ACDC +/-10%

Mechanical features

High impact resistance steel base. Screw mounting, screws not included (S base version). Self-extinguishing polycarbonate dome.

Optical features

2x SuperBright LEDs allow three luminous effects: flashing light (single flash 1F), strobe effect 5F, random light (a unique random effect consisting in an uneven flashing pattern, augmenting the ability of catching attention).

Light effects are controllable via independent electric contacts.

The dome-shaped Fresnel lens intensifies the luminous beam of these devices.



Feu à LED multifonction développé sur la base d'une technologie multicanale. FAROLAMP LED dispose de trois divers effets lumineux : lumière clignotante, effet stroboscopique, effet random.

Disponible avec deux bases de fixation (standard S et hampe P).

Tension d'utilisation

12/24V ACDC +/-10%

Caractéristiques mécaniques

Base en acier à haute résistance aux chocs et fixation par vis standards non fournies (version base S). Dôme en polycarbonate autoextinguible.

Caractéristiques optiques

2x LED SuperBright, produisent trois effets lumineux: lumière clignotante (simple éclat 1F), effet stroboscopique 5F, effet random (consistant en un clignotement aléatoire, qui permet au dispositif d'augmenter sa capacité d'attirer l'attention).

Les divers effets lumineux sont gérés par connexions électriques indépendantes.

Le dôme à lentille de Fresnel permet d'amplifier le faisceau lumineux de ces dispositifs.

FAROLAMP X



FAROLAMP X S

FAROLAMP X P

Cupole / Domes / Dômes



Base

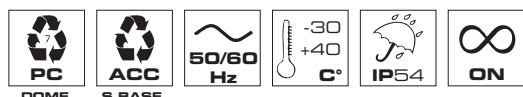

FAROLAMP X

V ACDC	12 ÷ 24	-
V AC	-	240
mA	900	450
	120	

Codici / Codes

FAROLAMP X*

BASES	●	●	●	●	●
S	12/24V ACDC	84970	85044	85370	84968
	240V AC	84971	85271	85371	84992
P	12/24V ACDC	84978	85033	85049	85037
	240V AC	84979	84982	85160	84995

* Fornito con lampada / Supplied with bulb / Fourni avec ampoule

RICAMBI CUPOLE / SPARE DOMES / DOMES DE RECHANGE

●	●	●	●
71325	71328	71329	71293

Luce allo Xenon ad alte performance ottiche. Disponibile con due basi di fissaggio (standard S e a palo P).

Tensione operativa

12/24V ACDC e 240V AC +/-10% (fornito con lampada)

Caratteristiche meccaniche

Base in acciaio ad alta resistenza agli impatti e fissaggio tramite viteria standard non fornita (versione base S). Cupola in policarbonato autoestingente.

Caratteristiche luminose

La lampada a scarica di Xenon da 6J e la cupola appositamente studiata garantiscono un potente flash singolo (1F).

Certificazioni / Certifications

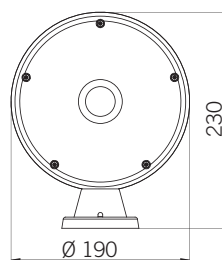
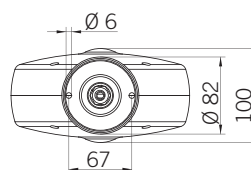

FAROLAMP X S

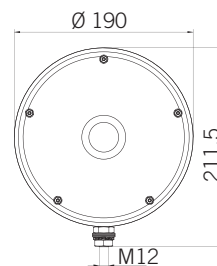

FAROLAMP X P



Xenon flashing beacon, delivering high optical performance. Two bases available (standard S and pole mount P).

Voltages

12/24V ACDC and 240V AC +/-10% (supplied with bulb)

Mechanical features

High impact resistance steel base. Screw mounting, screws not included (S base version). Self-extinguishing polycarbonate dome.

Optical features

6J Xenon discharge tube enhanced by the dome-shaped Fresnel lens provide a strong single flash (1F).



Feu au Xénon à haute performance optique. Disponible avec deux bases de fixation (standard S et hampe P).

Tension d'utilisation

12/24V ACDC ou 240V AC +/-10% (fourni avec ampoule)

Caractéristiques mécaniques

Base en acier à haute résistance aux chocs et fixation par vis standards non fournies (version base S). Dôme en polycarbonate autoextinguible.

Caractéristiques optiques

Tube à décharge au Xénon 6J et dôme spécialement conçu pour garantir un puissant flash simple éclat (1F).

STR



STR S

STR P

Cupole / Domes / Dômes



Base

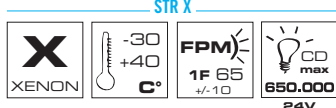
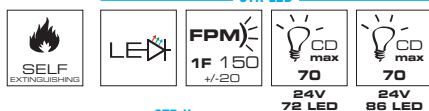
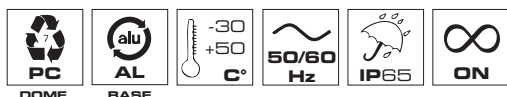

STR LED

V ACDC	24	-
V AC	-	240
mA 72 LED	420	40
mA 86 LED	450	60

STR X

V DC	12 ÷ 24	-
V AC	-	240
A	2,5	1,2
		0,15

Accessori / Accessories / Accessoires

GRIGLIA
GRID
GRILLE

Luce di grandi dimensioni disponibile in versione:

LED con tecnologia LED (5 mm)

X a flash con lampada a scarica di Xenon

Con l'utilizzo della griglia di protezione il prodotto è ideale per uso gravoso.

Tensione operativa

STR LED: 24V ACDC e 240V AC +/-10%

STR X: 12/24V DC, 240V AC +/-10% (fornito con lampada)

Caratteristiche meccaniche

Base in alluminio disponibile nella versione per fissaggio su base piana tramite viteria standard non fornita (STR S) e su base palo con attacco Ø 48,5 mm e due grani di fissaggio (STR P). Cupola in policarbonato autoestinguente ad alta resistenza agli impatti.

Caratteristiche luminose

STR LED (luce fissa/lampeggiante) disponibile nella versione con 72 LED e 86 LED Ø 5 mm (luce verticale).

STR X (luce a flash) con lampada Xenon da 15J, potente flash singolo 1F. Versioni 20J disponibili a richiesta.

Certificazioni / Certifications

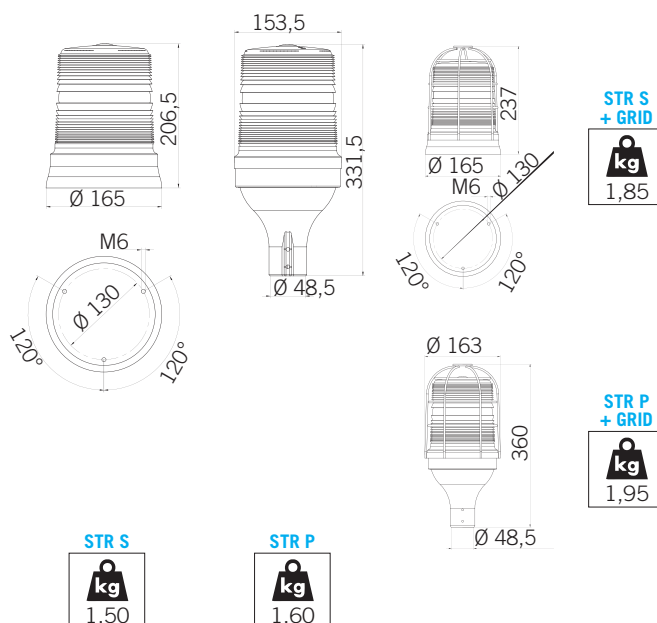

Large size beacon available in different versions:
LED with LED technology (5 mm)
X flashing light with Xenon discharge tube
With the protection grid the product is suitable for heavy-duty applications.

Voltages

STR LED: 24V ACDC and 240V AC +/-10%

STR X: 12/24V DC, 240V AC +/-10% (supplied with bulb)

Mechanical features

Aluminium base available for flat surface mounting through screws not included (STR S) or for pole mounted installations (Ø 48,5 mm) with 2 retaining dowels (STR P). Self-extinguishing high impact resistance PC dome.

Optical features

STR LED (steady/flashing light) available with 72 x 5 mm colored LEDs or 86 x 5 mm colored LEDs (vertical light).

STR X (Xenon flashing light) with 15J Xenon discharge tube, strong single flash 1F. 20J versions available on request.



Feu de grandes dimensions disponible en version :
LED avec technologie LED (5 mm)
X à éclats, avec tube à décharge au Xénon
Avec sa grille de protection, le produit est idéal pour une utilisation intensive.

Tension d'utilisation

STR LED : 24V ACDC et 240V AC +/-10%

STR X : 12/24V DC, 240V AC +/-10% (fourni avec ampoule)

Caractéristiques mécaniques

Base en aluminium disponible en version base plate avec fixation par vis standards non fournies (STR S) ou en version avec base hampe Ø 48,5 mm et deux vis sans tête (STR P). Dôme en polycarbonate à haute résistance aux chocs.

Caractéristiques optiques

STR LED (feu fixe/clignotant) disponible en version 72 LED ou 86 LED Ø 5 mm (lumière verticale).

STR X (feu à éclats) avec tube à décharge au Xénon 15J, un puissant flash simple éclat 1F. Versions 20J disponible sur demande.

Codici / Codes

STR LED

Luce fissa/lampeggiante a LED
LED Steady/flashing light
Feu fixe/clignotant à LED

72 LED

BASES				
S	24V ACDC	65792	65793	65796
	240V AC	65822	65823	65826
P	24V ACDC	65832	65833	65836
	240V AC	65862	65863	65866





86 LED

Luce verticale
Vertical light
Lumière verticale

BASES				
S	24V ACDC	65872	65873	65876
	240V AC	65902	65903	65906
P	24V ACDC	65912	65913	65916
	240V AC	65942	65943	65946

STR X*

Luce allo Xenon 15J 1F
Xenon flashing light 15J 1F
Feu au Xénon 15J 1F

BASES				
S	12/24V DC	22191	22192	22195
	240V AC	87760	87759	87763
P	12/24V DC	22281	22282	22285
	240V AC	87767	87768	87771

* Fornito con lampada / Supplied with bulb / Fourni avec ampoule

RICAMBI CUPOLE / SPARE DOMES / DOMES DE RECHANGE

		
71385	71388	71387

RICAMBI STR / STR SPARE PARTS / PIECES DETACHEES STR

P BASE for STR
83055

ACCESSORI / ACCESSORIES / ACCESSOIRES

GRID for STR	71693
--------------	-------



SEGNALATORI QUADRISTICA

La Quadristica è la gamma che include la segnalazione acustica e luminosa progettata per l'installazione a pannello.

Accanto alla linea tradizionale di ronzatori piezoelettrici, disponibili con diversi gradi di protezione e livelli acustici, alla linea P40, completa sia in termini di versioni sia di colori, proponiamo oggi la nuova gamma P50, indicatori acustici e luminosi, progettati per l'automazione e l'installazione a pannello, ideali per l'utilizzo in molteplici ambienti e applicazioni.

Le diverse soluzioni offerte dall'ampia scelta di prodotti consentono l'applicazione in qualsiasi tipologia di quadro elettrico: quadri elettrici di comando per il controllo dell'automazione, quadri elettrici di distribuzione e pannelli di controllo.

La Quadristica di **ELECTRA** rappresenta la migliore componentistica presente e richiesta dal mercato.

CARATTERISTICHE DELLA GAMMA

Le famiglie prodotto si suddividono in due categorie:

- **BUZZERS:** P50 A e P40 A (P40 A disponibile anche in versione JUNIOR), P50 A LED e P40 A LED (buzzers con luce a LED), BIMF LED (buzzer luminoso disponibile anche in colore rosso). Ronzatori ad incasso: BIP 92, BEBIP, BIP 84, BIP 81
- **DISPOSITIVI LUMINOSI A LED:** P50 S e P40 S (P40 S disponibile anche in versione JUNIOR), P50 RGB, P50 RGA e P40 RGA (dotati di LED multicolore). Dispositivi lineari: FWL 3.0 e LD 12 LINEAR.

GAMMA P50

Gli indicatori acustici e luminosi della gamma P50 sono progettati per l'automazione e l'installazione a pannello l foro Ø22. Sono sviluppati con connettore a montaggio rapido (versioni QC M12 4 PIN) o con pressacavo M12. Sono inoltre realizzati con tecnologia multicanale che consente di creare diversi livelli di allarme, selezionabili tramite contatti elettrici indipendenti. Gli indicatori, dotati di cupola illuminata (con diametro da 50 mm), costituiscono un punto di riferimento chiaramente visibile all'operatore e forniscono un'indicazione chiara dello stato dell'apparecchiatura.

Le versioni acustiche producono fino a sette tipologie di suono differenti. Gli indicatori ottici e ottico-acustici possono realizzare diversi effetti luminosi (dalla luce fissa all'effetto random, lampeggio casuale unico nel suo genere).

Sono inoltre disponibili le versioni RGA e RGB che consentono diverse colorazioni con un unico dispositivo.

Performance ottiche e acustiche eccellenti per l'automazione e la segnalazione a pannello.

Nel grafico viene presentata la gamma completa progettata per l'installazione a pannello, tenendo conto dell'ingombro dei singoli prodotti. Il grafico suddivide la gamma in base alle esigenze di segnalazione. Per una soluzione di suono e luce, proponiamo i dispositivi P50 A LED e P40 A LED, disponibili con diversi colori di cupola, mentre per esigenze legate ad una segnalazione acustica offriamo diversi buzzers completi anche di indicatori luminosi a LED di colore rosso.

Tra le soluzioni luminose, oltre ai modelli disponibili con diversi colori di cupola, proponiamo le luci multicolore P50 RGB, P50 RGA e P40 RGA che consentono di selezionare diverse colorazioni con un unico dispositivo.

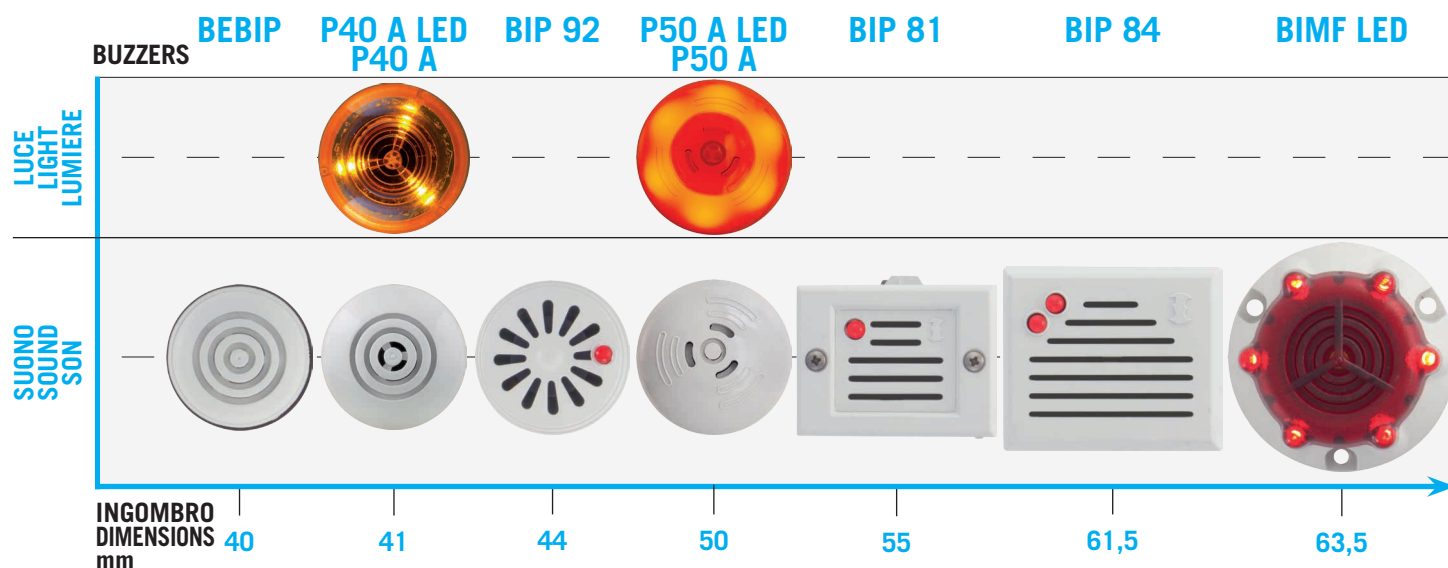



SIGNALING DEVICES FOR CONTROL PANELS

This range includes acoustic and luminous signaling devices engineered for panel mount applications.

Besides traditional piezoelectric sounders, available with different IP grades and sound pressure levels, P40 range, complete in dome and base colors, we have developed the new P50 series, audible and light indicators engineered for automation and installation on electrical panels, the ideal choice for most demanding environments and applications.

Multiple solutions offered by the wide product portfolio allow installation in the most demanding panel applications: electrical control switchboards for automation, distribution and control panels.

ELECTRA panel mount devices represent the best components on the market.

RANGE FEATURES

Product families of this range can be divided in two categories:

- **BUZZERS:** P50 A and P40 A buzzers (P40 A JUNIOR versions also available), P50 A LED and P40 A LED (buzzer, with LED light), BIMF LED (luminous buzzer, red version also available). Buzzers for flush mount applications: BIP 92, BEBIP, BIP 84, BIP 81.
- **LED LUMINOUS DEVICES:** P50 S and P40 S (P40 S JUNIOR versions also available), P50 RGB, P50 RGA and P40 RGA (developed with multicolor LED). Linear warning lights: FWL 3.0 and LD 12 LINEAR.

P50 RANGE

The audible and light indicators of P50 range have been engineered for automation and installation on high-end electrical panels I Ø22 holes.

P50 has been developed with quick connectors (QC M12 4 PIN versions) or with M12 cable gland. Based on a multichannel technology, these allow different levels of alarm via independent electrical contacts.

Illuminated dome (Ø50) provides easy-to-see operator guidance and indication of machinery status.

Audible indicators benefit from seven types of alarm. Light and audible I light indicators provide different sound/light effects (from steady light to random effect, consisting in an uneven flashing pattern).

RGA and RGB multicolor versions are also available, allowing different colors in one device.

Outstanding acoustic and optical performance for automation and panel mount applications.

The graph shows the complete range engineered for panel mount applications, considering dimensions of each product and signaling needs. For a combined luminous/acoustic solution we propose P50 A LED and P40 A LED, domes available in different colors. For acoustic only signaling we offer different buzzers, also with red LED indicators.

Among the luminous solutions available, we propose devices in different colors as well as multicolor LED beacons P50 RGB, P50 RGA and P40 RGA: these devices allow different colors with a single device.



AVERTISSEURS POUR TABLEAUX DE COMMANDE

Cette gamme comprend toute la signalisation acoustique et lumineuse conçue pour les installations sur les tableaux de commande.

Parallèlement à la ligne traditionnelle de buzzers piézoélectriques, disponible avec degrés de protection et niveaux acoustiques différents, et à la gamme P40, complète par rapport aux versions et aux couleurs des dômes et des bases disponibles, il s'ajoute aujourd'hui la nouvelle gamme P50, les avertisseurs sonores et lumineux développés pour l'automatisation industrielle ainsi que pour l'installation sur les panneaux électriques, un choix cohérent par rapport aux besoins du secteur industriel.

Les différentes solutions offertes par ce large choix de produits permettent les applications dans n'importe quel type de tableaux de commande électrique pour l'automatisme ou la distribution ou le contrôle.

Les Avertisseurs Sonores et Lumineux **ELECTRA** de Sirena sont les meilleurs composants disponibles sur leur marché.

CARACTERISTIQUE DE LA GAMME

Les familles de produits se partagent en deux catégories :

- **BUZZERS:** P50 A et P40 A (P40 A disponibles aussi en version JUNIOR), P50 A LED et P40 A LED (buzzers à LED), BIMF LED (buzzer lumineux, disponible aussi en couleur rouge). Buzzers pour installation à encastrement : BIP 92, BEBIP, BIP94, BIP81.
- **AVERTISSEURS LUMINEUX A LED:** P50 S et P40 S (P40 S aussi disponible en version JUNIOR), P50 RGB, P50 RGA et P40 RGA (équipés de LED multicolore). Dispositifs linéaires : FWL 3.0 et LD 12 LINEAR.

GAMME P50

Les avertisseurs sonores et lumineux de la gamme P50 ont été développés pour l'automatisation industrielle ainsi que pour une installation de haute qualité sur les panneaux électriques, trou de perçage 22 mm.

La famille des P50 a été développée avec des connecteurs rapides (version QC M12 4 PIN) et avec presse-étoupe M12. Leur technologie multicanale permet la signalisation de plusieurs niveaux d'alarme programmables par des connexions électriques séparées.

Les feux (50 mm) offrent un signal visuel clair de l'état de fonctionnement des machines pour l'opérateur.

Les avertisseurs sonores bénéficient de sept types d'alarme et les avertisseurs lumineux offrent sept effets (du simple fixe au clignotement aléatoire). Les combinés sonores et lumineux permettent de nombreuses combinaisons de signaux : Sonore + lumineux | Sonore seul | Lumineux seul.

Aussi disponible, les feux multicolores RGA et RGB qui rendent possible la variation de couleurs sur un même dispositif.

Des performances acoustiques et visuelles exceptionnelles au service de l'automatisation et des installateurs de tableaux de commande.

Le graphique montre la gamme complète conçue pour montage sur panneau, considérant l'encombrement des dispositifs individuels. Le graphique partage la gamme en fonction des besoins de signalisation. Pour une solution comprenant sonnerie et lumière, nous offrons le P50 A LED et P40 A LED, disponible en différentes couleurs de dôme, tandis que pour des exigences liées à une signalisation acoustique nous offrons différents buzzers complets avec avertisseurs lumineux LED de couleur rouge.

Parmi les solutions lumineuses, en différentes couleurs de dôme, nous proposons les feux multicolores P50 RGB, P50 RGA et P40 RGA qui permettent de sélectionner différentes couleurs dans un seul dispositif.

DISPOSITIVI LUMINOSI / LUMINOUS DEVICES / DISPOSITIFS LUMINEUX

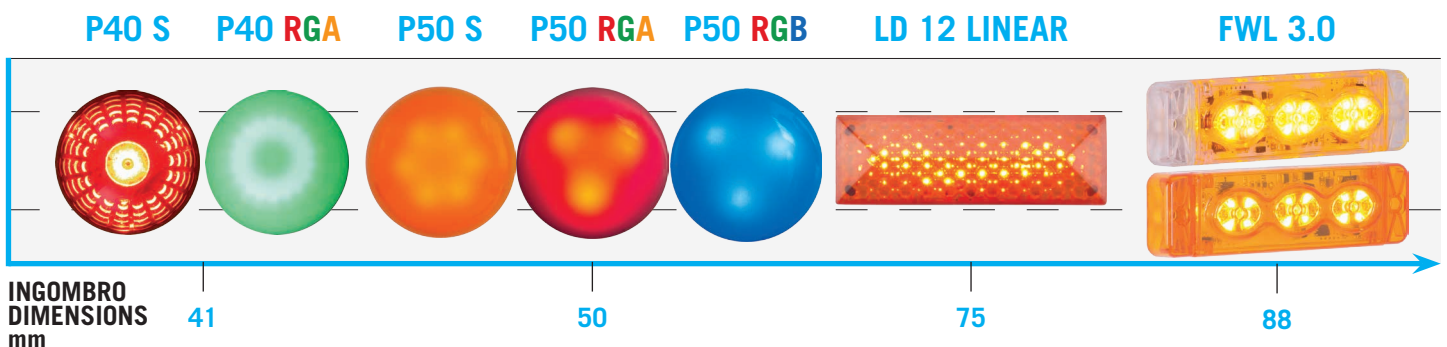

P50 A



P50 A QC M12



P50 A

92 dB max

Cupole / Domes / Dômes

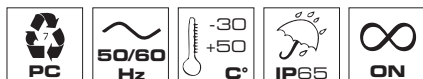

Corpo / Body / Corps

P50 A QC M12
P50 A

V DC	12 ÷ 24	-	-	-
V AC	-	-	12 ÷ 24	-
mA	15	25	40	70
dB(A)1m	80	88	86	92

Codici / Codes

P50 A QC M12

12/24V ACDC	91367	91368

P50 A

12/24V ACDC	91327	91328

Buzzer piezoelettrico multifunzione, sviluppato con tecnologia multicanale. P50 A consente sette modalità di allarme selezionabili tramite contatti elettrici indipendenti. Disponibili versioni con connettore a montaggio rapido QC M12 o con pressacavo M12.

Tensione operativa

12/24V ACDC +/-5%

Caratteristiche meccaniche

Polycarbonato autoestinguento ad alta resistenza agli impatti, guarnizione o-ring in EPDM presente sulla cupola e guarnizione in poliuretano sulla base. Può essere installato a pannello tramite foro Ø22 e bloccato con l'anello di chiusura fornito. Connessione elettrica tramite connettore a montaggio rapido (QC M12 4 PIN) o con pressacavo M12.

Caratteristiche acustiche

Circuito acustico con buzzer multitenzione.

Sette suoni disponibili (Suono Continuo - Suono Intermittente Lento, Suono Intermittente Veloce, Suono Intermittente Triplo, Telegrafo, Random). Frequenza: 3500+/-100Hz.

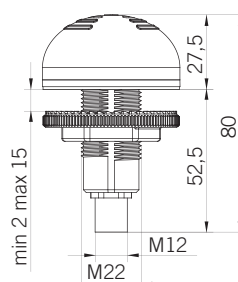
Certificazioni / Certifications

P50 A QC M12

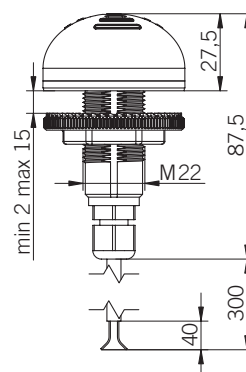

P50 A



Multi-function piezoelectric sounder, developed with a multichannel technology. P50 A allows seven different types of alarm controllable via independent electric contacts. Versions available with QC M12 connector or M12 cable gland.

Voltagess

12/24V ACDC +/-5%

Mechanical features

Self-extinguishing PC body totally protected against vibrations, dust and atmospheric elements. EPDM o-ring on dome and polyurethane gasket on base. Can be panel mounted through a M22 hole and secured with the locking ring provided. Electrical connection through QC M12 4 PIN connector or M12 cable gland.

Acoustic features

Electronic circuit with multitenion buzzer. Seven sounds available (Continuous sound, Slow Intermittent Sound, Fast Intermittent Sound, Double Intermittent Sound, Triple Intermittent Sound, Telegraph, Random). Sound frequency: 3500+/-100Hz.



Buzzer piézoélectrique multifonctionnel, développé avec une technologie multicanale. P50 A permet sept types d'alarme sélectionnables par contacts électriques indépendants. Disponible en version à connexion rapide QC M12 ou avec presse-étoupe M12.

Tension d'utilisation

12/24V ACDC +/-5%

Caractéristiques mécaniques

Polycarbonate autoextinguible, à haute résistance aux chocs, joint O-ring en EPDM présent sur le dôme et joint en polyuréthane sur la base. Il peut être encastré (trou de perçage 22 mm de diamètre) et sécurisé avec la bague de serrage fournie. Connexion électrique rapide QC M12 avec 4 contacts ou avec presse-étoupe M12.

Caractéristiques acoustiques

Circuit acoustique avec buzzer multitenion. Sept types d'alarme sélectionnables (Son continu - Son pulsé lent, Son pulsé rapide, Double son pulsé, Triple son pulsé, Télégraphe, aléatoire). Fréquence: 3500+/-100Hz.

P40 A



P40 A
P40 A JUNIOR

85 dB max

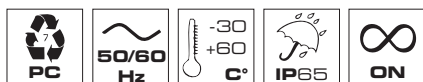

P40 A

V DC	12	24	-	-	-	-
V AC	-	-	12	24	48 ÷ 240	
mA	10	15	50	60	20	15
dB(A)1m	85					

P40 A JUNIOR

V DC	12	24	-	-	-	-
V AC	-	-	12	24	90 ÷ 240	
mA	10	10	20	25	10	20
dB(A)1m	70					

Codici / Codes

P40 A

12/24V ACDC	91177	91178
48/240V AC	91179	91180

P40 A JUNIOR

12/24V ACDC	91208	91207
90/240V AC	91210	91209

Buzzer piezoelettrico sviluppato con tecnologia multicanale. P40 A consente due livelli di allarme (pre-allarme, allarme) selezionabili tramite contatti elettrici indipendenti.

Tensione operativa

P40 A: 12/24V ACDC, 48/240V AC +/-10%

P40 A JUNIOR: 12/24V ACDC, 90/240V AC +/-10%

Caratteristiche meccaniche

Polycarbonato autoestinguente ad alta resistenza agli impatti, guarnizione o-ring in EPDM presente sulla cupola e guarnizione in poliuretano sulla base. Può essere installato a pannello tramite foro Ø30 e bloccato con l'anello di chiusura fornito.

Caratteristiche acustiche

Circuito acustico con buzzer multitemperatura

Suono intermittente (pre-allarme)

Suono continuo (allarme)

Frequenza:

P40 A: 3500+/-100Hz

P40 A JUNIOR: 3000+/-100Hz

Certificazioni / Certifications

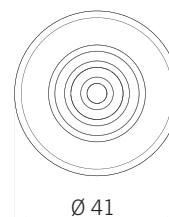
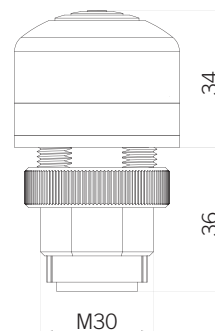

P40 A
P40 A JUNIOR



Piezoelectric sounder developed with a multichannel technology. P40 A allows two different levels of alarm (pre-alarm, alarm) controllable via independent electric contacts.

Voltages

P40 A: 12/24V ACDC, 48/240V AC +/-10%

P40 A JUNIOR: 12/24V ACDC, 90/240V AC +/-10%

Mechanical features

Self-extinguishing PC body totally protected against vibrations, dust and atmospheric elements. EPDM o-ring on dome and polyurethane gasket on base. Can be panel mounted through a 30 mm hole and secured with the locking ring provided.

Acoustic features

Electronic circuit with multitemperature buzzer

Intermittent Sound (pre-alarm)

Continuous sound (alarm)

Sound frequency:

P40 A: 3500+/-100Hz

P40 A JUNIOR: 3000+/-100Hz



Buzzer piézo-électrique développé avec technologie multicanale. P40 A permet deux niveaux d'alarme (pré-alarme, alarme) sélectionnables par contacts électriques indépendants.

Tension d'utilisation

P40 A : 12/24V ACDC, 48/240V AC +/-10%

P40 A JUNIOR : 12/24V ACDC, 90/240V AC +/-10%

Caractéristiques mécaniques

Polycarbonate autoextinguible, à haute résistance aux chocs, joint O-ring en EPDM présent sur le dôme et joint en polyuréthane sur la base.

Il peut être encastré (trou de perçage 30 mm de diamètre) et sécurisé avec la bague de serrage fournie.

Caractéristiques acoustiques

Circuit acoustique avec buzzer multitemperatura

Son pulsé (pré-alarme)

Son continu (alarme)

Fréquence:

P40 A : 3500+/-100Hz

P40 A JUNIOR : 3000+/-100Hz

P50 A LED



P50 A LED QC M12

P50 A LED

92 dB max

Cupole / Domes / Dômes



Corpo / Body / Corps



P50 A LED QC M12
P50 A LED

V DC	12 ÷ 24	-	-
V AC	-	-	12 ÷ 24
mA	45	45	90 110
dB(A)1m	80	88	86 92

Codici / Codes

P50 A LED QC M12



12/24V ACDC 91381 91382 91383 91384 91386

P50 A LED



12/24V ACDC 91341 91342 91343 91344 91346

Buzzer piezoelettrico con luce LED multifunzione, sviluppato con tecnologia multicanale. P50 A LED consente diverse modalità acustico/luminose selezionabili tramite contatti elettrici indipendenti: Luce fissa, Suono continuo, Luce fissa + Suono continuo, 2 Flash - suono/luce sync, 3 Flash - suono/luce sync, Intermittente - suono/luce sync, Random - suono/luce no sync.

Disponibili versioni con connettore a montaggio rapido QC M12 o con pressacavo M12.

Tensione operativa

12/24V ACDC +/-5%

Caratteristiche meccaniche

Polycarbonato autoestinguente ad alta resistenza agli impatti, guarnizione o-ring in EPDM presente sulla cupola e guarnizione in poliuretano sulla base. Può essere installato a pannello tramite foro Ø22 e bloccato con l'anello di chiusura fornito. Connessione elettrica tramite connettore a montaggio rapido (QC M12 4 PIN) o con pressacavo M12.

Caratteristiche luminose

6 LED ad alta luminosità. Cupola in polycarbonato trasparente.

Caratteristiche acustiche

Circuito acustico con buzzer multitemperatura.

Cinque suoni disponibili. Frequenza: 3500+/-100Hz.

Certificazioni / Certifications

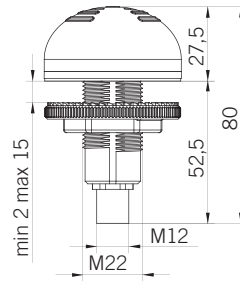

P50 A LED QC M12

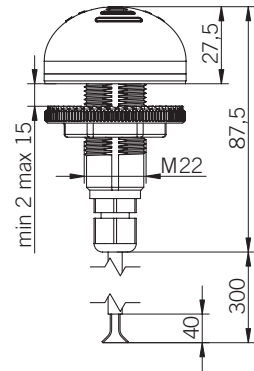

P50 A LED



Multi-function piezoelectric sounder with LED light, developed with a multichannel technology. P50 A LED allows different sound/light effects controllable via independent electric contacts: Steady light, Continuous sound, Steady light + Continuous sound, 2 Flashes - sync sound/light, 3 Flashes - sync sound/light, Intermittent - sync sound/light, Random - no sync sound/light. Versions available with QC M12 connector or M12 cable gland.

Voltages

12/24V ACDC +/-5%

Mechanical features

Self-extinguishing PC body totally protected against vibrations, dust and atmospheric elements. EPDM o-ring on dome and polyurethane gasket on base. Can be panel mounted through a M22 hole and secured with the locking ring provided. Electrical connection through QC M12 4 PIN connector or M12 cable gland.

Optical features

6 bright LEDs. Polycarbonate dome.

Acoustic features

Electronic circuit with multitemperature buzzer. Five sounds available. Frequency: 3500+/-100Hz.



Buzzer piézoélectrique multifonctionnel à LED, développé avec une technologie multicanale. P50 A LED permet différents types d'alarme sélectionnables par contacts électriques indépendants : Lumière fixe, Son continu, Lumière fixe + Son continu, 2 Flash + son/lumière sync, 3 Flash + son/lumière sync, Pulsé - son/lumière sync, Random - son/lumière no sync. Disponible en version à connexion rapide QC M12 ou avec presse-étoupe M12.

Tension d'utilisation

12/24V ACDC +/-5%

Caractéristiques mécaniques

Polycarbonate autoextinguible, à haute résistance aux chocs, joint O-ring en EPDM présent sur le dôme et joint en polyuréthane sur la base. Il peut être encastré (trou de perçage 22 mm de diamètre) et sécurisé avec la bague de serrage fournie. Connexion électrique rapide QC M12 avec 4 contacts ou avec presse-étoupe M12.

Caractéristiques optiques

6 LED à haute luminosité. Dôme en polycarbonate.

Caractéristiques acoustiques

Circuit acoustique avec buzzer multitempérature. Cinq sons disponibles. Fréquence : 3500+/-100Hz.

P40 A LED



P40 A LED

85 dB max

Cupole / Domes / Dômes



Corpo / Body / Corps

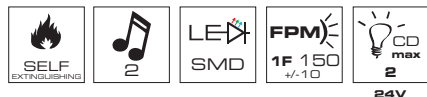
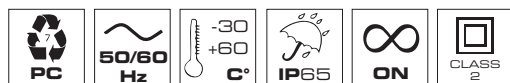

P40 A LED

V DC	12	24	-	-	-	-
V AC	-	-	12	24	48 ÷ 240	
mA	25	30	80	110	30	20
dB(A)1m	85					

Codici / Codes

P40 A LED

12/24V ACDC	91181	91182	91183	91184	91185	91186
48/240V AC	91201	91202	91203	91204	91205	91206
12/24V ACDC	91191	91192	91193	91194	91195	91196
48/240V AC	91211	91212	91213	91214	91215	91216

Buzzer piezoelettrico con luce a LED, sviluppato con tecnologia multicanale. P40 A LED consente tre livelli di allarme (allerta, pre-allarme, allarme) selezionabili tramite contatti elettrici indipendenti.

Tensione operativa

12/24V ACDC, 48/240V AC +/-10%

Caratteristiche meccaniche

Polycarbonato autoestinguente ad alta resistenza agli impatti, guarnizione o-ring in EPDM presente sulla cupola e guarnizione in poliuretano sulla base. Può essere installato a pannello tramite foro Ø30 e bloccato con l'anello di chiusura fornito.

Caratteristiche luminose

3 LED ad alta luminosità. Cupola in polycarbonato trasparente. Effetti luminosi: Luce lampeggiante, Luce lampeggiante + Suono intermittente, Luce fissa + Suono continuo.

Caratteristiche acustiche

Circuito acustico con buzzer multitemperatura
Suono intermittente (pre-allarme)
Suono continuo (allarme)
Frequenza: 3500+/-100Hz

Certificazioni / Certifications

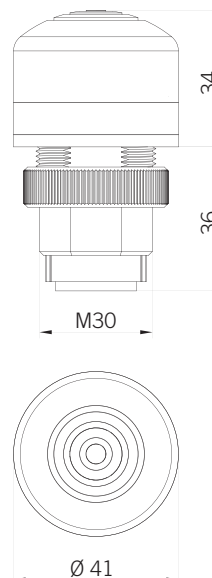

P40 A LED



Piezoelectric sounder with LED light, developed with a multichannel technology. P40 A LED allows three levels of alarm (alert, pre-alarm, alarm) controllable via independent electric contacts.

Voltages

12/24V ACDC, 48/240V AC +/-10%

Mechanical features

Self-extinguishing PC body totally protected against vibrations, dust and atmospheric elements. EPDM o-ring on dome and polyurethane gasket on base. Can be panel mounted through a 30 mm hole and secured with the locking ring provided.

Optical features

3 bright LEDs. Transparent polycarbonate dome. Light effects: Flashing light, Flashing light + Intermittent sound, Steady light + Continuous sound.

Acoustic features

Electronic circuit with multitemperature buzzer
Intermittent Sound (pre-alarm)
Continuous sound (alarm)
Sound frequency: 3500+/-100Hz



Buzzer piézo-électrique à LED, développé avec une technologie multicanale. P40 A LED permet trois niveaux d'alarme (alerte, pré-alarme, alarme) sélectionnables par contacts électriques indépendants.

Tension d'utilisation

12/24V ACDC, 48/240V AC +/-10%

Caractéristiques mécaniques

Polycarbonate autoextinguible, à haute résistance aux chocs, joint O-ring en EPDM présent sur le dôme et joint en polyuréthane sur la base. Il peut être encastré (trou de perçage 30 mm de diamètre) et sécurisé avec la bague de serrage fournie.

Caractéristiques optiques

3 LED à haute luminosité. Dôme en polycarbonate transparent. Effets lumineux : Lumière clignotante, Lumière clignotante + Son pulsé, Lumière fixe + Son continu.

Caractéristiques acoustiques

Circuit acoustique avec buzzer multitemperatura
Son pulsé (pré-alarme)
Son continu (alarme)
Fréquence : 3500+/-100Hz

BIMF LED



BIMF LED

85 dB max



BIMF LED

V ACDC	12 ÷ 24 ÷ 48 ÷ 110 ÷ 240
mA	25 12 12 10 13
dB(A)1m	85

Codici / Codes

BIMF LED

12/240V ACDC

38030

38032

Buzzer multifunzione acustico-luminoso sviluppato con capsula acustica piezoelettrica.

Tensione operativa

12/240V ACDC +/-10%

Caratteristiche meccaniche

Corpo, rondella e ghiera in ABS. Il fissaggio avviene tramite viteria standard oppure tramite ghiera per installazione retroquadro (Ø 12 mm). Fornito adattatore per foro Ø 16 mm - Ø 22 mm.

Caratteristiche luminose

6 LED di colore rosso. Luce fissa (con suono continuo) o lampeggiante (in modalità lenta o veloce) con suono intermittente (rispettivamente lento o veloce).

Caratteristiche acustiche

Capsula acustica piezoelettrica.

Suono continuo - Suono intermittente lento/veloce selezionabili tramite dip-switch.

Frequenza: 2500+/-500Hz.

Certificazioni / Certifications

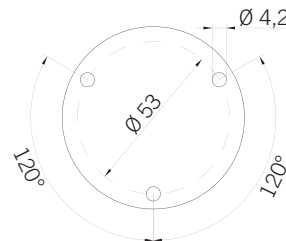
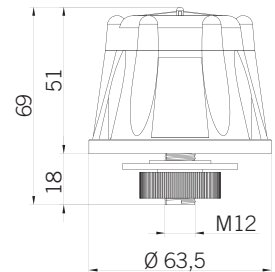
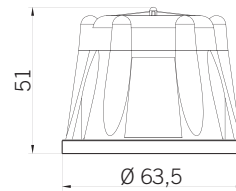

BIMF LED



Multifunctional sounder with LED light developed with acoustic piezoelectric capsule.

Voltages

12/240V ACDC +/-10%

Mechanical features

ABS body, washer and lock ring. Screw mounting or flush mounting through the lock ring provided (Ø 12 mm). Adapter for holes Ø 16 mm - Ø 22 mm supplied with the product.

Optical features

6 red LEDs. Steady light (with continuous sound) or flashing light (slow or fast mode) with Intermittent sound (respectively slow or fast mode).

Acoustic features

Acoustic piezoelectric capsule
Continuous sound - Slow/Fast Intermittent
selectable via dip-switch.
Sound frequency: 2500+/-500Hz



Buzzer multifonctionnel acoustico-lumineux développé avec capsule acoustique piézo-électrique.

Tension d'utilisation

12/240V ACDC +/-10%

Caractéristiques mécaniques

Corps, rondelle et bague en ABS. Fixation par vis standards ou par bague pour installation à encastrer (Ø 12 mm). Fourni adaptateur pour trou Ø 16 mm - Ø 22 mm.

Caractéristiques optiques

6 LED rouges. Lumière fixe (avec son continu) ou clignotante (lente ou rapide) avec son pulsé (respectivement lent ou rapide).

Caractéristiques acoustiques

Capsule acoustique piézo-électrique.
Son continu - Son pulsé lent ou rapide
sélectionnables par dip-switch.
Fréquence : 2500+/-500Hz

BIP 92



BIP 92

75 dB max



BIP 92

V ACDC	12	24	48	-	-
V DC	-	-	-	110	240
V AC	-	-	-	110	240
mA	5				
dB(A)1m	75				

Codici / Codes

BIP 92

	○	●
12V ACDC	42318	33080
24V ACDC	42319	33081
48V ACDC	42320	33082
110V DC	42321	33083
110V AC	42322	33084
240V DC	42325	33088
240V AC	42326	33087

Buzzer ad incasso sviluppato con capsula acustica piezoelettrica.

Tensione operativa

12V ACDC, 24V ACDC, 48V ACDC, 110V DC, 110V AC, 240V DC, 240V AC +/-10%

Caratteristiche meccaniche

Corpo e ghiera in PC. Installazione retroquadro per foro tondo (Ø 16 - 22 - 30 mm) tramite ghiera.

Caratteristiche acustiche

Capsula acustica piezoelettrica.

Suono intermittente.

Frequenza: 3600Hz.

Certificazioni / Certifications

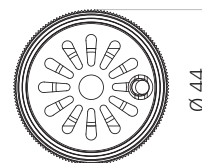
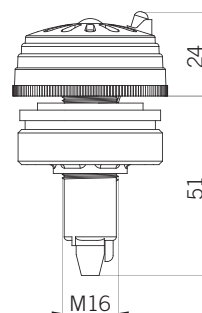

BIP 92



Panel mount sounder developed with acoustic piezoelectric capsule.

Voltages

12V ACDC, 24V ACDC, 48V ACDC, 110V DC, 110V AC, 240V DC, 240V AC +/-10%

Mechanical features

PC body and lock ring. Flush mounting (holes Ø 16 - 22 - 30 mm) through the lock ring provided.

Acoustic features

Acoustic piezoelectric capsule.

Intermittent sound.

Sound frequency: 3600Hz.



Buzzer pour installation à encastrer développé avec capsule acoustique piézo-électrique.

Tension d'utilisation

12V ACDC, 24V ACDC, 48V ACDC, 110V DC, 110V AC, 240V DC, 240V AC +/-10%

Caractéristiques mécaniques

Corps et bague en PC. Installation à encastrer avec trou rond (Ø 16 - 22 - 30 mm) par la bague fournie.

Caractéristiques acoustiques

Capsule acoustique piézo-électrique

Son pulsé.

Fréquence : 3600Hz.

BEBIP

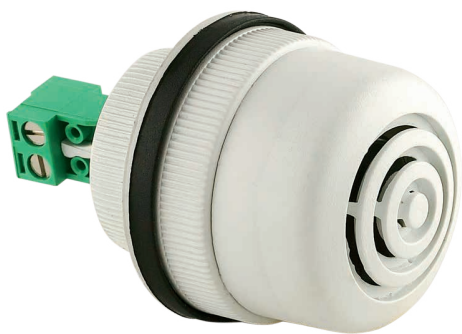

BEBIP

82 dB max

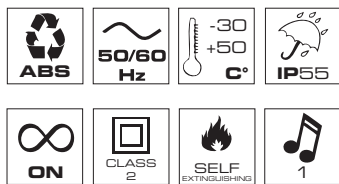

	BEBIP				
V ACDC	12	24	48	-	-
V DC	-	-	-	110	240
V AC	-	-	-	110	240
mA	7				
dB(A)1m	82				

Codici / Codes

BEBIP

12V ACDC	38000
24V ACDC	38001
48V ACDC	38002
110V DC	38003
110V AC	38004
240V DC	38005
240V AC	38006

Buzzer ad incasso sviluppato con capsula acustica piezoelettrica.

Tensione operativa

12V ACDC, 24V ACDC, 48V ACDC, 110V DC, 110V AC, 240V DC, 240V AC +/-10%

Caratteristiche meccaniche

Corpo e ghiera in ABS. Installazione retroquadro per foro tondo (Ø 16 - 22 - 30 mm) tramite ghiera.

Caratteristiche acustiche

Capsula acustica piezoelettrica.
Suono intermittente. Frequenza: 4000+/-300Hz.

Certificazioni / Certifications

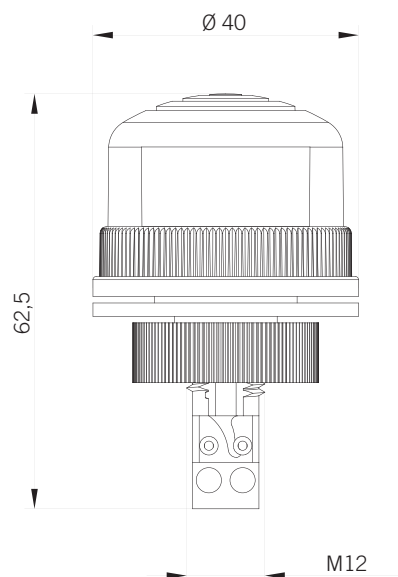

BEBIP



Panel mount sounder developed with acoustic piezoelectric capsule.

Voltages

12V ACDC, 24V ACDC, 48V ACDC, 110V DC, 110V AC, 240V DC, 240V AC +/-10%

Mechanical features

ABS body and lock ring. Flush mounting (holes Ø 16 - 22 - 30 mm) through the lock ring provided.

Acoustic features

Acoustic piezoelectric capsule.
Intermittent sound.
Sound frequency: 4000+/-300Hz.



Buzzer pour installation à encastrer développé avec capsule acoustique piézo-électrique.

Tension d'utilisation

12V ACDC, 24V ACDC, 48V ACDC, 110V DC, 110V AC, 240V DC, 240V AC +/-10%

Caractéristiques mécaniques

Corps et bague en ABS. Installation à encastrer avec trou rond (Ø 16 - 22 - 30 mm) par la bague fournie.

Caractéristiques acoustiques

Capsule acoustique piézo-électrique.
Son pulsé.
Fréquence : 4000+/-300Hz.

BIP 84



BIP 84

80 dB max



BIP 84

V ACDC	12	24	48	-	-
V DC	-	-	-	110	240
V AC	-	-	-	110	240
mA	6				
dB(A)1m	80				

Codici / Codes

BIP 84

12V ACDC	42345	33060
24V ACDC	42346	30061
48V ACDC	42347	33065
110V DC	42348	33067
110V AC	42349	33063
240V DC	42352	33069
240V AC	42353	33066

Buzzer ad incasso sviluppato con capsula acustica piezoelettrica. Dotato di due LED di segnalazione.

Tensione operativa

12V ACDC, 24V ACDC, 48V ACDC, 110V DC, 110V AC, 240V DC, 240V AC +/-10%

Caratteristiche meccaniche

Corpo in PC e ghiera in alluminio. Installazione retroquadro per foro tondo (Ø 30 mm) tramite ghiera.

Caratteristiche acustiche

Capsula acustica piezoelettrica.
Suono intermittente.
Frequenza: 2200/3500Hz.

Certificazioni / Certifications

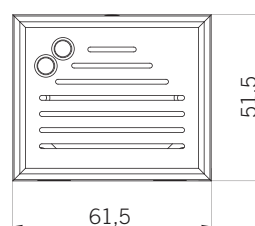
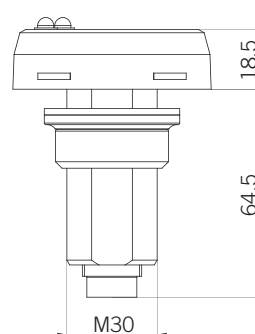

BIP 84



Panel mount sounder with LED light developed with acoustic piezoelectric capsule.

Voltages

12V ACDC, 24V ACDC, 48V ACDC, 110V DC, 110V AC, 240V DC, 240V AC +/-10%

Mechanical features

PC body and aluminium lock ring. Flush mounting (holes Ø 30 mm) through the lock ring provided.

Acoustic features

Acoustic piezoelectric capsule.
Intermittent sound.
Sound frequency: 2200/3500Hz.



Buzzer pour installation à encastrer développé avec capsule acoustique piézo-électrique et équipé avec deux LED de signalisation.

Tension d'utilisation

12V ACDC, 24V ACDC, 48V ACDC, 110V DC, 110V AC, 240V DC, 240V AC +/-10%

Caractéristiques mécaniques

Corps en PC et bague en aluminium. Installation à encastrer avec trou rond (Ø 30 mm) par la bague fournie.

Caractéristiques acoustiques

Capsule acoustique piézo-électrique.
Son pulsé.
Fréquence : 2200/3500Hz.

BIP 81



BIP 81

72 dB max



BIP 81

V ACDC	12	24	48	-	-
V DC	-	-	-	110	240
V AC	-	-	-	110	240
mA				3,5	
dB(A)1m				72	

Codici / Codes

BIP 81

	—●—	—●—
12V ACDC	42300	33010
24V ACDC	42301	33011
48V ACDC	42302	33015
110V DC	42303	33040
110V AC	42304	33012
240V DC	42307	33042
240V AC	42308	33014

Buzzer ad incasso sviluppato con capsula acustica piezoelettrica.

Tensione operativa

12V ACDC, 24V ACDC, 48V ACDC, 110V DC, 110V AC, 240V DC, 240V AC +/-10%

Caratteristiche meccaniche

Corpo in PC. Installazione retroquadro per foro quadro.

Caratteristiche acustiche

Capsula acustica piezoelettrica.

Suono intermittente.

Frequenza: 1800Hz.

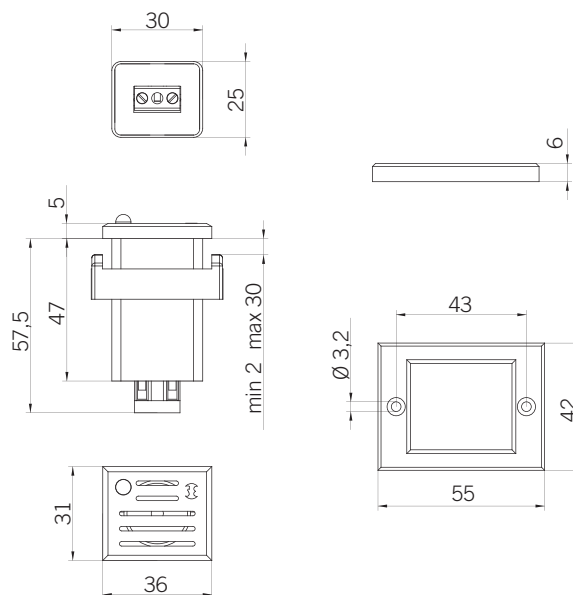
Certificazioni / Certifications

BIP 81



Panel mount sounder developed with acoustic piezoelectric capsule.

Voltages

12V ACDC, 24V ACDC, 48V ACDC, 110V DC, 110V AC, 240V DC, 240V AC +/-10%

Mechanical features

PC body. Flush mounting for square holes.

Acoustic features

Acoustic piezoelectric capsule.

Intermittent sound.

Sound frequency: 1800Hz.



Buzzer pour installation à encastrer développé avec capsule acoustique piézo-électrique.

Tension d'utilisation

12V ACDC, 24V ACDC, 48V ACDC, 110V DC, 110V AC, 240V DC, 240V AC +/-10%

Caractéristiques mécaniques

Corps en PC. Installation à encastrer avec trou carré.

Caractéristiques acoustiques

Capsule acoustique piézo-électrique.

Son pulsé.

Fréquence : 1800Hz.

P50 S

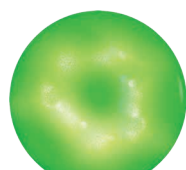

P50 S QC M12



P50 S

Cupole / Domes / Dômes

Corpo / Body / Corps

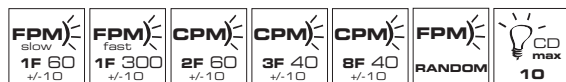

P50 S QC M12
P50 S

V DC	12 ÷ 24	-	-
V AC	-	-	12 ÷ 24
mA	40	30	70 60

Codici / Codes

P50 S QC M12

12/24V ACDC 91361 91362 91363 91364 91366

P50 S

12/24V ACDC 91321 91322 91323 91324 91326

Luce a LED multifunzione sviluppata con tecnologia multicanale. P50 S dispone di sette effetti luminosi selezionabili tramite contatti elettrici indipendenti. Disponibili versioni con connettore a montaggio rapido QC M12 o con pressacavo M12.

Tensione operativa
12/24V ACDC +/-5%

Caratteristiche meccaniche

Polycarbonato autoestinguente ad alta resistenza agli impatti, guarnizione o-ring in EPDM presente sulla cupola e guarnizione in poliuretano sulla base. Può essere installato a pannello tramite foro Ø22 e bloccato con l'anello di chiusura fornito. Connessione elettrica tramite connettore a montaggio rapido (QC M12 4 PIN) o con pressacavo M12.

Caratteristiche luminose

6 LED ad alta luminosità. Cupola in polycarbonato con design per la diffusione luminosa sui 360°.

Sette effetti luminosi (luce fissa, lampeggio lento, lampeggio veloce, doppio flash, triplo flash, strobo, random).

Certificazioni / Certifications

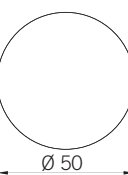
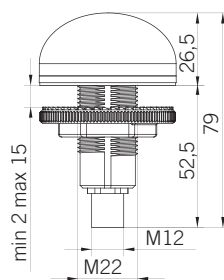

P50 S QC M12

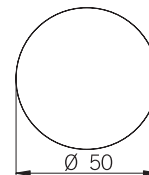
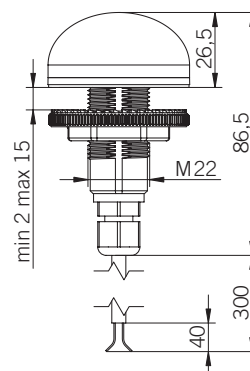

P50 S



Multifunctional LED beacon developed with a multichannel technology. P50 S allows seven different light effects controllable via independent electric contacts. Versions available with QC M12 connector or M12 cable gland.

Voltages
12/24V ACDC +/-5%

Mechanical features

Self-extinguishing PC body totally protected against vibrations, dust and atmospheric elements. EPDM o-ring on dome and polyurethane gasket on base. Can be panel mounted through a M22 hole and secured with the locking ring provided. Electrical connection through QC M12 4 PIN connector or M12 cable gland.

Optical features

6 bright LEDs. Polycarbonate dome with 360 degrees light-diffusion design. Seven different light effects (steady light, slow flashing, fast flashing, double flash, triple flash, strobe and random).



Feu LED multifonctionnel, développé avec technologie multicanale. P50 S permet sept effets lumineux sélectionnables par contacts électriques indépendants. Disponible en version à connexion rapide QC M12 ou avec presse-étoupe M12.

Tension d'utilisation
12/24V ACDC +/-5%

Caractéristiques mécaniques

Polycarbonate autoextinguible, à haute résistance aux chocs, joint O-ring en EPDM présent sur le dôme et joint en polyuréthane sur la base. Il peut être encastré (trou de perçage 22 mm de diamètre) et sécurisé avec la bague de serrage fournie. Connexion électrique rapide QC M12 avec 4 contacts ou avec presse-étoupe M12.

Caractéristiques optiques

6 LED à haute luminosité. Dôme en polycarbonate développé pour une diffusion lumineuse sur 360°. Sept effets lumineux (lumière fixe, lumière clignotante lente, lumière clignotante rapide, double flash, triple flash, stroboscopique, aléatoire).

P40 S



P40 S
P40 JUNIOR

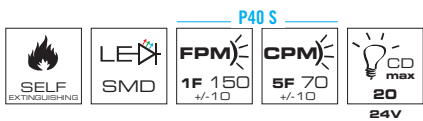

P40 S

V DC	12	24	-	-	-	-
V AC	-	-	12	24	48 ÷ 240	
mA	60	45	110	130	40	25

P40 JUNIOR

V DC	12	24	-	-	-	-
V AC	-	-	12	24	90 ÷ 240	
mA	25	25	30	45	20	35

Codici / Codes

P40 S

12/24V ACDC	91131	91132	91133	91134	91135	91136
48/240V AC	91151	91152	91153	91154	91155	91156

12/24V ACDC	91141	91142	91143	91144	91145	91146
48/240V AC	91161	91162	91163	91164	91165	91166

P40 JUNIOR

12/24V ACDC	91221	91222	91223	91224	91225	91226
90/240V AC	91241	91242	91243	91244	91245	91246

12/24V ACDC	91231	91232	91233	91234	91235	91236
90/240V AC	91251	91252	91253	91254	91255	91256

Luce a LED multifunzione sviluppata con tecnologia multicanale. P40 S dispone di tre livelli di allarme (luce fissa, lampeggiante, strobo) selezionabili tramite contatti elettrici indipendenti.

Tensione operativa

P40 S: 12/24V ACDC, 48/240V AC +/-10%

P40 JUNIOR: 12/24V ACDC, 90/240V AC +/-10%

Caratteristiche meccaniche

Polycarbonato autoestinguente ad alta resistenza agli impatti, guarnizione o-ring in EPDM presente sulla cupola e guarnizione in poliuretano sulla base. Può essere installato a pannello tramite foro Ø30 e bloccato con l'anello di chiusura fornito.

Caratteristiche luminose

4 LED ad alta luminosità. Cupola in polycarbonato con design per la diffusione luminosa sui 360°, abbinata ad una lente posizionata sulla parte alta del dispositivo al fine di migliorarne la performance frontale.

3 effetti luminosi (luce fissa, lampeggiante, strobo).

Certificazioni / Certifications

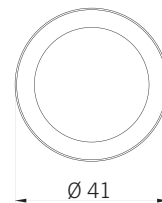
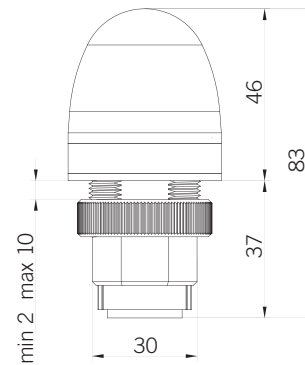

P40 S
P40 S JUNIOR



Multifunctional LED beacon developed with a multichannel technology. P40 S allows three different levels of alarm (steady, flashing, strobe light effect) controllable via independent electric contacts.

Voltages

P40 S: 12/24V ACDC, 48/240V AC +/-10%

P40 JUNIOR: 12/24V ACDC, 90/240V AC +/-10%

Mechanical features

Self-extinguishing PC body totally protected against vibrations, dust and atmospheric elements. EPDM o-ring on dome and polyurethane gasket on base. Can be panel mounted through a 30 mm hole and secured with the locking ring provided.

Optical features

4 bright LEDs. Polycarbonate dome with 360 degrees light-diffusion design in conjunction with a light-concentrating lens on the top of the device to maximize frontal performance. Three light effects (steady, flashing, strobe light effect).



Feu LED multifonctionnel, développé avec une technologie multicanale. P40 S permet trois niveaux d'alarme (lumière fixe, clignotante, strobo) sélectionnables par contacts électriques indépendants.

Tension d'utilisation

P40 S : 12/24V ACDC, 48/240V AC +/-10%

P40 JUNIOR : 12/24V ACDC, 90/240V AC +/-10%

Caractéristiques mécaniques

Polycarbonate autoextinguible, à haute résistance aux chocs, joint O-ring en EPDM présent sur le dôme et joint en polyuréthane sur la base. Il peut être encastré (trou de perçage 30 mm de diamètre) et sécurisé avec la bague de serrage fournie.

Caractéristiques optiques

4 LED à haute luminosité. Dôme en polycarbonate développé pour une diffusion lumineuse sur 360°, à l'aide d'une lentille positionnée sur la partie supérieure du dispositif, qui permet d'améliorer la performance optique du produit. Trois effets lumineux (lumière fixe, clignotante, strobo).

P50 RGB



P50 RGB QC M12

P50 RGB

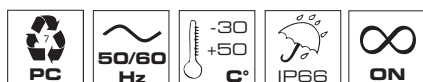

Corpo / Body / Corps

P50 RGB QC M12
P50 RGB

V DC	12 ÷ 24	-	-
V AC	-	-	12 ÷ 24
mA	140	80	280 180

Codici / Codes

P50 RGB QC M12

12/24V ACDC 91378

P50 RGB

12/24V ACDC 91337

Luce a LED multicolore sviluppata con tecnologia multicanale. P50 RGB permette di realizzare sette diversi colori a luce fissa.

Disponibili versioni con connettore a montaggio rapido QC M12 o con pressacavo M12.

Tensione operativa

12/24V ACDC +/-5%

Caratteristiche meccaniche

Polycarbonato autoestinguente ad alta resistenza agli impatti, guarnizione o-ring in EPDM presente sulla cupola e guarnizione in poliuretano sulla base. Può essere installato a pannello tramite foro Ø22 e bloccato con l'anello di chiusura fornito. Connessione elettrica tramite connettore a montaggio rapido (QC M12 4 PIN) o con pressacavo M12.

Caratteristiche luminose

3 LED RGB ad alta luminosità. La cupola in polycarbonato opalino diffonde la luce in modo omogeneo permettendo di esaltare la performance luminosa di ciascun colore.

Sette colori a luce fissa (bianco, ambra, rosso, giallo, verde, magenta, blu).

Certificazioni / Certifications

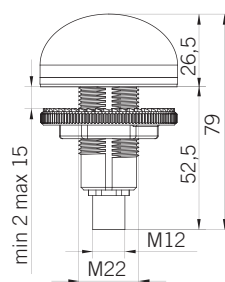

P50 RGB QC M12

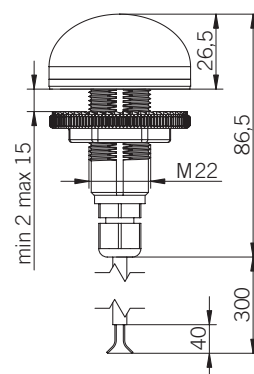

P50 RGB

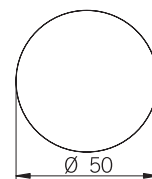
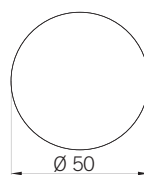

Multicolor LED beacon developed with a multichannel technology. P50 RGB allows steady light in seven different colors.

Versions available with QC M12 connector or M12 cable gland.

Voltages

12/24V ACDC +/-5%

Mechanical features

Self-extinguishing PC body totally protected against vibrations, dust and atmospheric elements. EPDM o-ring on dome and polyurethane gasket on base. Can be panel mounted through a M22 hole and secured with the locking ring provided. Electrical connection through QC M12 4 PIN connector or M12 cable gland.

Optical features

3 bright RGB LEDs. Polycarbonate opaline dome for a smooth coloring of the device according to the selected color. Steady light in different colors (white, amber, red, yellow, green, magenta, blue).



Feu LED multicolore, développé avec technologie multicanale. P50 RGB produit sept couleurs à lumière fixe.

Disponible en version à connexion rapide QC M12 ou avec presse-étoupe M12.

Tension d'utilisation

12/24V ACDC +/-5%

Caractéristiques mécaniques

Polycarbonate autoextinguible, à haute résistance aux chocs, joint O-ring en EPDM présent sur le dôme et joint en polyuréthane sur la base. Il peut être encastré (trou de perçage 22 mm de diamètre) et sécurisé avec la bague de serrage fournie. Connexion électrique rapide QC M12 avec 4 contacts ou avec presse-étoupe M12.

Caractéristiques optiques

3 LED RGB à haute luminosité. Dôme en polycarbonate opalin permet une diffusion homogène de la lumière et d'exalter les performances lumineuses de chaque couleur. Sept couleurs à lumière fixe (blanc, orange, rouge, jaune, vert, magenta, bleu).

P50 RGA



P50 RGA

Corpo / Body / Corps

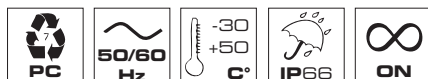

P50 RGA

V DC	12	24	-	-
V AC	-	-	12	24
mA	60	40	150	120

Codici / Codes

P50 RGA

—●—●—●—	—●—●—●—
12V ACDC	91447
24V ACDC	91427

Luce a LED multicolore sviluppata con tecnologia multicanale. P50 RGA dispone di tre colorazioni a luce fissa (rosso, verde e ambra) selezionabili tramite contatti elettrici indipendenti.

Fornito con pressacavo M12.

Tensione operativa

12V ACDC, 24V ACDC +/-5%

Caratteristiche meccaniche

Polycarbonato autoestinguente ad alta resistenza agli impatti, guarnizione o-ring in EPDM presente sulla cupola e guarnizione in poliuretano sulla base. Può essere installato a pannello tramite foro Ø22 e bloccato con l'anello di chiusura fornito. Connessione elettrica tramite pressacavo M12.

Caratteristiche luminose

6 LED RG ad alta luminosità. La cupola in polycarbonato opalino diffonde la luce in modo omogeneo permettendo di esaltare la performance luminosa di ciascun colore a luce fissa (rosso, verde, ambra).

Certificazioni / Certifications

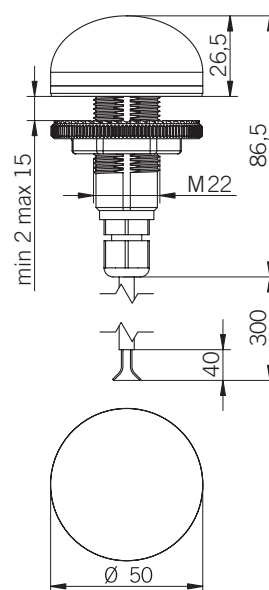

P50 RGA



Multicolor LED beacon developed with a multichannel technology. P50 RGA allows steady light in three different colors (red, green, amber) controllable via independent electric contacts. Supplied with M12 cable gland.

Voltages

12V ACDC, 24V ACDC +/-5%

Mechanical features

Self-extinguishing PC body totally protected against vibrations, dust and atmospheric elements. EPDM o-ring on dome and polyurethane gasket on base. Can be panel mounted through a M22 hole and secured with the locking ring provided. Electrical connection through M12 cable gland.

Optical features

6 bright RG LEDs. Polycarbonate opaline dome for a smooth coloring of the device according to the selected color. Steady light in three colors (red, green, amber).



Feu LED multicolore, développé avec une technologie multicanale. P50 RGA produit trois couleurs (rouge, vert, orange) à lumière fixe, sélectionnables par contacts électriques indépendants.

Fourni avec presse-étoupe M12.

Tension d'utilisation

12V ACDC, 24V ACDC +/-5%

Caractéristiques mécaniques

Polycarbonate autoextinguible, à haute résistance aux chocs, joint O-ring en EPDM présent sur le dôme et joint en polyuréthane sur la base. Il peut être encastré (trou de perçage 22 mm de diamètre) et sécurisé avec la bague de serrage fournie. Connexion électrique avec presse-étoupe M12.

Caractéristiques optiques

6 LED RG à haute luminosité. Dôme en polycarbonate opalin permet une diffusion homogène de la lumière et d'exalter les performances lumineuses de chaque couleur à lumière fixe (rouge, vert, orange).

P40 RGA



P40 RGA

Corpo / Body / Corps

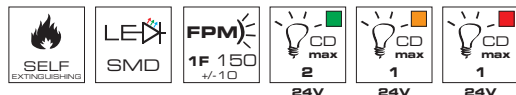

P40 RGA						
V DC	12	24	-	-	-	-
V AC	-	-	12	24	48 ÷ 240	
mA	50	40	110	115	40	20

Codici / Codes

P40 RGA

—●—	—●●●—	
12/24V ACDC	91167	91168
48/240V AC	91171	91172
—●—	—●●●—	
12/24V ACDC	91169	91170
48/240V AC	91173	91174

Luce a LED multicolore sviluppata con tecnologia multicanale. P40 RGA dispone di tre colorazioni (rosso, verde e ambra) selezionabili tramite contatti elettrici indipendenti. Disponibile in versione luce fissa (STEADY) o lampeggiante (FLASHING).

Tensione operativa

12/24V ACDC, 48/240V AC +/-10%

Caratteristiche meccaniche

Polycarbonato autoestinguente ad alta resistenza agli impatti, guarnizione o-ring in EPDM presente sulla cupola e guarnizione in poliuretano sulla base. Può essere installato a pannello tramite foro Ø30 e bloccato con l'anello di chiusura fornito.

Caratteristiche luminose

1 LED RGA ad alta luminosità. Cupola in polycarbonato opalino diffonde la luce in modo omogeneo permettendo di esaltare la performance luminosa di ciascun colore (rosso, verde, ambra).

Certificazioni / Certifications

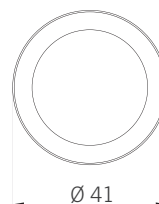
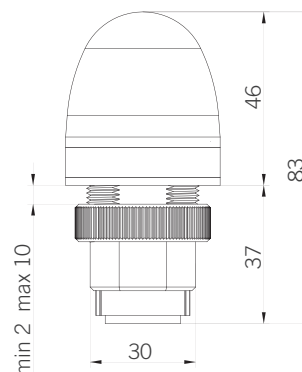

P40 RGA



Multicolor LED beacon developed with a multichannel technology. P40 RGA allows three different colors (red, green, amber) controllable via independent electric contacts. Available in steady or flashing light version.

Voltages

12/24V ACDC, 48/240V AC +/-10%

Mechanical features

Self-extinguishing PC body totally protected against vibrations, dust and atmospheric elements. EPDM o-ring on dome and polyurethane gasket on base. Can be panel mounted through a 30 mm hole and secured with the locking ring provided.

Optical features

1 bright RGA LED. Polycarbonate opaline dome for a smooth coloring of the device according to the selected color (red, green, amber).



Feu LED multicolore, développé avec technologie multicanale. P40 RGA produit trois couleurs (rouge, vert, orange) sélectionnables par contacts électriques indépendants. Disponible en version lumière fixe (STEADY) ou clignotante (FLASHING).

Tension d'utilisation

12/24V ACDC, 48/240V AC +/-10%

Caractéristiques mécaniques

Polycarbonate autoextinguible, à haute résistance aux chocs, joint O-ring en EPDM présent sur le dôme et joint en polyuréthane sur la base. Il peut être encastré (trou de perçage 30 mm de diamètre) et sécurisé avec la bague de serrage fournie.

Caractéristiques optiques

1 LED RGA à haute luminosité. Dôme en polycarbonate opalin, permet une diffusion homogène de la lumière et d'exalter les performances lumineuses de chaque couleur (rouge, vert, orange).

FWL 3.0

allCOLOR



FWL 3.0

Cupole / Domes / Dômes



FWL 3.0

V DC	12	24	-	-
V AC	-	-	12	24
mA	90	67	55	65

Codici / Codes

FWL 3.0

allCOLOR	90980	90981	90982	90979	90983
allCLEAR	90984	90985	90986	90987	

Segnalatore lineare a LED. **FWL 3.0** è dotato di una particolare lente che amplifica l'intensità luminosa, rendendolo superluminoso e quindi ideale per applicazioni in cui la segnalazione è importante ma dove sono richieste dimensioni ridotte.

Il segnalatore dispone di due effetti luminosi: effetto flash e luce fissa a bassa intensità. Possibilità di sincronizzazione tra più dispositivi.

Disponibile con lente **allCOLOR** e **allCLEAR**.

Tensione operativa

12/24V ACDC +/-10%

Caratteristiche meccaniche

Cupola e corpo in polycarbonato.

Caratteristiche luminose

Il segnalatore è dotato di gruppo ottico, costituito da 3 LED superluminosi e da una particolare lente che amplifica l'intensità luminosa ad effetto flash. Il dispositivo produce inoltre luce fissa a bassa intensità.

Disponibile con due tipologie di lente:

allCOLOR

Lente colorata con sorgente luminosa colorata

allCLEAR

Lente neutra con sorgente luminosa colorata

Certificazioni / Certifications

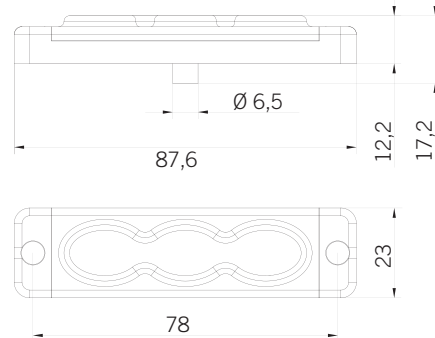

FWL 3.0



LED linear warning light. **FWL 3.0** is provided with a lens, especially engineered to intensify the flashing light effect.

The device offers excellent optical performance and is the ideal choice when the signaling function is important but where compact size is required.

The device allows two light effects: flashing light and low intensity steady light.

Synchronization of more devices possible.

Available with **allCOLOR** and **allCLEAR** lens.

Voltages

12/24V ACDC +/-10%

Mechanical features

Unbreakable polycarbonate lens and housing

Optical features

The device is provided with an optical group made up of 3 superbright LED and a lens especially engineered to intensify the light intensity of flashing effect.

The device can also produce low intensity steady light.

Available with 2 different lens types:

allCOLOR

Colored lens with colored light source

allCLEAR

Clear lens with colored light source



Dispositif linéaire à LED. **FWL 3.0** est équipé avec une lentille qui permet d'augmenter l'intensité lumineuse et rend le dispositif super lumineux et donc idéal pour une signalisation efficace avec dimensions réduites.

Le dispositif linéaire permet deux effets lumineux : effet flash ou lumière fixe à basse intensité.

Il est possible la synchronisation entre plusieurs dispositifs.

Disponibile avec lentille **allCOLOR** et **allCLEAR**.

Tension d'utilisation

12/24V ACDC +/-10%

Caractéristiques mécaniques

Lentille et corps en polycarbonate.

Caractéristiques optiques

Le dispositif est équipé avec groupe optique, constitué par 3 LED superlumineuses et par une lentille conçue pour augmenter l'intensité lumineuse à effet flash.

Il produit aussi une lumière fixe à basse intensité.

Disponibile avec deux types de lentille :

allCOLOR

Lentille colorée et source lumineuse colorée

allCLEAR

Lentille incolore transparente et source lumineuse colorée

LD 12 LINEAR



LD 12 LINEAR STEADY/FLASHING

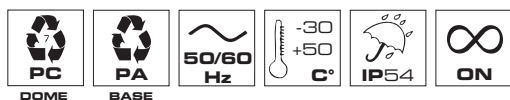

LD 12 LINEAR STEADY/FLASHING

V ACDC	24	-
V AC	-	240
mA	65	10

Codici / Codes

LD 12 LINEAR STEADY/FLASHING

24V ACDC	66460	66461	66462	66463	66464	66465
240V AC	66466	66467	66468	66469	66470	66471

LD 12 LINEAR STEADY/FLASHING è un dispositivo lineare a LED dal design compatto che produce luce fissa/lampeggiante.

Tensione operativa

24V ACDC, 240V AC +/-10%

Caratteristiche meccaniche

Base in poliammide e cupola in policarbonato autoestinguente ad alta resistenza agli impatti. Fissaggio tramite viteria standard non fornita.

Caratteristiche luminose

12 LED ad elevata definizione ottica. Luce fissa/lampeggiante.

Certificazioni / Certifications

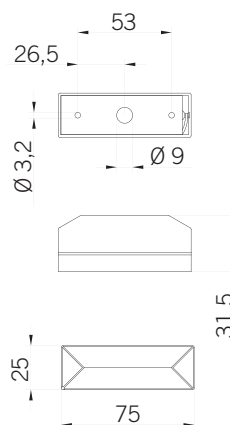

LD 12 LINEAR STEADY/FLASHING



LD 12 LINEAR STEADY/FLASHING is a compact size LED linear warning light, providing steady/flashing light.

Voltages

24V ACDC, 240V AC +/-10%

Mechanical features

Polyamide base and self-extinguishing high impact resistance polycarbonate dome. Screw mounting, screws not included.

Optical features

12 LEDs with high optical performance providing steady/flashing light.



LD 12 LINEAR STEADY/FLASHING est un feu linéaire à LED de design compact. Il produit une lumière fixe/clignotante.

Tension d'utilisation

24V ACDC, 240V AC +/-10%

Caractéristiques mécaniques

Base en polyamide et dôme en polycarbonate autoextinguible à haute résistance aux chocs. Installation par vis (non fournies).

Caractéristiques optiques

12 LED à haute définition optique. Lumière fixe/clignotante.

LAMPADIE RICAMBIO

SPARE BULBS

AMPOULES DE RECHANGE



BA 15d

5W

scatola: box: boîte :	1x25 pz. 1x25 pcs. 1x25 pcs.	singola single individuelle	25 pz. 25 pcs. 25 pcs.
12V	70970	70941	27780
24V	70971	70942	27781
48V	70972	70943	27782
110V	70973	70944	27783
240V	70974	70945	27784

CTL 600 STEADY, CTL 600 STEADY/FLASHING,
MICROLAMP STEADY, MICROLAMP STEADY/FLASHING,
OVOLUX STEADY, OVOLUX FLASHING



BA 15d

10W

scatola: box: boîte :	1x25 pz. 1x25 pcs. 1x25 pcs.	singola single individuelle	25 pz. 25 pcs. 25 pcs.
12V	70975	70946	27785
24V	70976	70947	27786
48V	70977	70948	27787
110V	70978	70949	27788
240V	70979	70950	27789

CTL 900 STEADY, CTL 900 STEADY/FLASHING,
OVOLUX STEADY, OVOLUX FLASHING



BA 15d

25W

scatola: box: boîte :	1x12 pz. 1x12 pcs. 1x12 pcs.	singola single individuelle	12 pz. 12 pcs. 12 pcs.
12V	70980	70951	72773
24V	70981	70952	72774
48V	70982	70953	72775
110V	70983	70954	72776
240V	70984	70955	72777

CTL 1200 STEADY, CTL 1200 STEADY/FLASHING,
MINIFLASH STEADY, MINIFLASH STEADY/FLASHING,
MAXIFLASH STEADY, MAXIFLASH STEADY/FLASHING



BA 15d

40W

scatola: box: boîte :	1x12 pz. 1x12 pcs. 1x12 pcs.	singola single individuelle	12 pz. 12 pcs. 12 pcs.
12V	70985	70956	72745
24V	70986	70957	72746
48V	70987	70958	72747
110V	70988	70959	72748
240V	70989	70960	72749

MAXIFLASH STEADY, MAXIFLASH STEADY/FLASHING,
ROTALLARM S STEADY/FLASHING,
ROTALLARM HD STEADY/FLASHING



BA 15s

45W

per versioni DC
for DC versions
pour versions CC

12V	71600
24V	71601
48V	71606

ROTALLARM S, ROTALLARM HD



E14T

25W

per versioni AC
for AC versions
pour versions CA

48V	71663
110V	71625
240V	71640

ROTALLARM S, ROTALLARM HD



H1

12V (55W)	71602
24V (70W)	71603

ROTALLARM S H1, ROTALLARM HD H1,
ROTALLARM HD FLASHING H1,
ROTALLARM S FLASHING H1, TYPE 200 H1



XENON

1J 70912

CTL 900 X, MICROLAMP X



XENON

2J 71634

OVOLUX X, MINIFLASH X



XENON

6J 71639

CTL 1200 X, FAROLAMP X,
MAXIFLASH X, ROTALLARM S X,
ROTALLARM HD X



XENON

15J 71638

STR X

LAMPADE A LED LED BULBS AMPOULES A LED



6V ACDC
12V ACDC
24V ACDC
48V ACDC
110V ACDC
240V AC

32701	32702	32703	32708	32705	32706
32711	32712	32713	32718	32715	32716
32721	32722	32723	32728	32725	32726
32731	32732	32733	32738	32735	32736
32741	32742	32743	32748	32745	32746
32751	32752	32753	32758	32755	32756

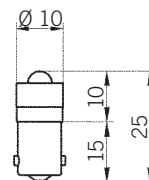

Confezione 10 pz. / 10 pc. box / Boîte de 10 pcs.



6V ACDC
12V ACDC
24V ACDC
48V ACDC
110V ACDC
240V AC

32761	32762	32763	32768	32765	32766
32771	32772	32773	32778	32775	32776
32781	32782	32783	32788	32785	32786
32791	32792	32793	32798	32795	32796
32801	32802	32803	32808	32805	32806
32811	32812	32813	32818	32815	32816

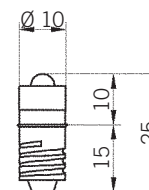

Confezione 10 pz. / 10 pc. box / Boîte de 10 pcs.



12V ACDC
24V ACDC
48V ACDC
110V AC
240V AC

29781	29782	29783	29788	29785	29786
29791	29792	29793	29798	29795	29796
29801	29802	29803	29808	29805	29806
29811	29812	29813	29818	29815	29816
29821	29822	29823	29828	29825	29826

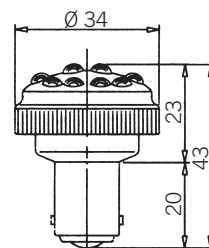

12V ACDC
24V ACDC
48V ACDC
110V AC
240V AC

28531	28532	28533	28538	28535	28536
28541	28542	28543	28548	28545	28546
28551	28552	28553	28558	28555	28556
28561	28562	28563	28568	28565	28566
28571	28572	28573	28578	28575	28576

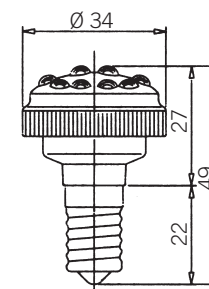

12V ACDC
24V ACDC
48V ACDC
110V AC
240V AC

27941	27942	27943	27948	27945	27946
27951	27952	27953	27958	27955	27956
29301	29302	29303	29308	29305	29306
28491	28492	28493	28498	28495	28496
28881	28882	28883	28888	28885	28886

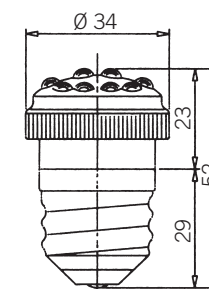



LD 103
BA 15d

12V ACDC
24V ACDC
48V ACDC
110V ACDC
240V AC

29491	29492	29493	29498	29495	29496
27801	27802	27803	27808	27805	27806
29501	29502	29503	29508	29505	29506
29511	29512	29513	29518	29515	29516
29521	29522	29523	29528	29525	29526

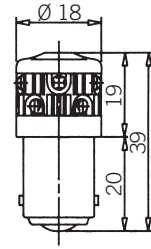

LD 4.5.4 WO
BA 15d

12V ACDC
24V ACDC
110V AC
240V AC

40931	40932	40933	40934	40935	40936
40941	40942	40943	40944	40945	40946
40951	40952	40953	40954	40955	40956
40961	40962	40963	40964	40965	40966

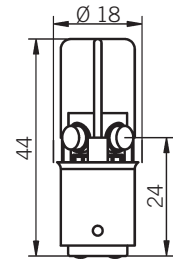

LD 205
BA 15d

12V ACDC
24V ACDC
48V ACDC
110V AC
240V AC

29691	29692	29693	29698	29695	29696
27991	27992	27993	27998	27995	27996
29701	29702	29703	29708	29705	29706
29711	29712	29713	29718	29715	29716
29721	29722	29723	29728	29725	29726

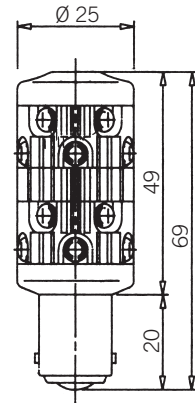

LD 205
E14

12V ACDC
24V ACDC
48V ACDC
110V AC
240V AC

28431	28432	28433	28438	28435	28436
28441	28442	28443	28448	28445	28446
28451	28452	28453	28458	28455	28456
28461	28462	28463	28468	28465	28466
28471	28472	28473	28478	28475	28476

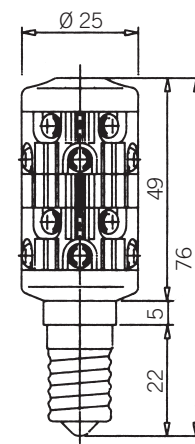



EE

NORMATIVE E SPECIFICHE TECNICHE

La **Direttiva Europea Macchine 2006/42/CE** stabilisce l'installazione obbligatoria a bordo macchina di idonei dispositivi di segnalazione acustica e luminosa, essenziali alla sicurezza degli operatori in ambito industriale.

Gran parte degli argomenti trattati nella direttiva sono relativi ad aspetti progettuali per la messa in sicurezza globale del "sistema macchina". Il punto 2 dell'introduzione mette in risalto, con quanto segue, la sempre crescente importanza che la segnalazione a bordo macchina ha assunto nel tempo:

"Il settore delle macchine costituisce una parte importante del settore della meccanica ed è uno dei pilastri industriali dell'economia comunitaria. Il costo dovuto all'alto numero di infortuni provocati direttamente dall'utilizzazione delle macchine può essere ridotto integrando la sicurezza nella progettazione e nella costruzione stessa delle macchine, nonché effettuando una corretta installazione e manutenzione".

Sirena ha concentrato la propria attenzione nello sviluppo della segnalazione adatta a tutti i diversi stati di sicurezza che il sistema prevede, senza abbandonare una filosofia che accompagna il nostro modus operandi da sempre, ovvero: "Un segnale deve sempre essere in grado di avvisare di un pericolo imminente e deve indicare l'inizio e la durata di una situazione pericolosa".

LINEA ACUSTICA

Le norme internazionali in materia di sicurezza in ambienti industriali stabiliscono l'installazione obbligatoria di idonei dispositivi di segnalazione acustica, attivabili in caso di allarme, pericolo o emergenza, per la sicurezza degli addetti ai moderni processi di produzione.

Le variabili del segnale acustico fissate dalle norme internazionali in materia di sicurezza sono:

- il livello di pressione acustica misurato in Decibel (dB)
- il campo di frequenza del suono in Hertz (Hz)
- la distanza tra dispositivo e destinatario
- la presenza di altre fonti di rumore

Il livello in dB deve essere superiore di 15dB rispetto al livello di rumorosità ambientale e in ogni caso maggiore di 65dB; mentre la frequenza centrale del segnale acustico deve essere compresa tra i 300 e i 3000 Hz e differire il più possibile dalla frequenza centrale in cui il rumore ambientale è più forte.

L'applicazione di queste regole necessita l'utilizzo del fonometro (strumento che consente di rilevare il livello in dB e la frequenza in Hz) e dei dati tecnici di ogni modello di segnalatore acustico, presenti in questo catalogo. I dati relativi al livello acustico dei segnalatori Sirena forniscono il livello di pressione acustica in dB misurati in camera anecoica alla distanza di un metro sull'asse del segnalatore: i dati forniti a catalogo si riferiscono al livello acustico massimo.

Per una corretta ed efficace installazione è sufficiente sovrapporre idealmente lo spettro acustico del segnalatore prescelto allo spettro acustico della rumorosità ambientale, in modo da evidenziare il differenziale di livello di pressione acustica in dB e il differenziale di campo di frequenza in Hz.

DECIBEL dB(1m) - UNITÀ DI MISURA PER IL LIVELLO SONORO

Il Decibel è l'unità di misura del livello sonoro, ma per la portata non esistono indicazioni del tutto valide: fattori come tipo di suono, velocità e direzione del vento, umidità dell'aria, nebbia e pioggia, possono influenzare in maniera considerevole la portata del suono. La tabella sotto riportata indicante il raggio d'azione serve come valore di riferimento teorico.

PROPAGAZIONE ONDE SONORE - LA PORTATA DEL SUONO DIFFUSION OF SOUND WAVES - SOUND INTENSITY PROPAGATION DES VAGUES SONORES - PORTEE SONORE

1000 ÷ 3000 Hz

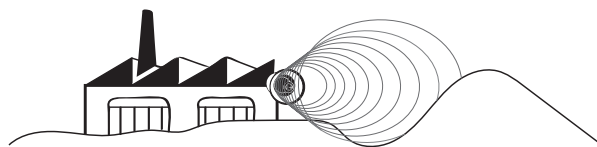
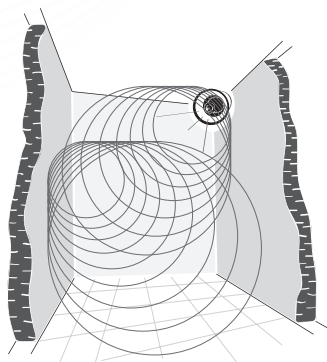

300 ÷ 500 Hz

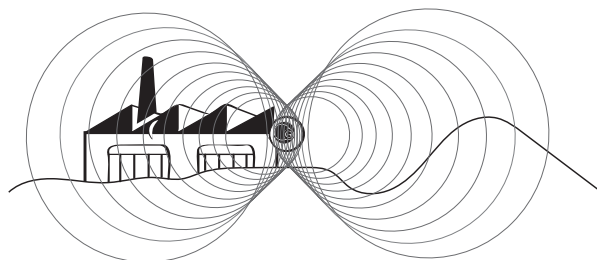
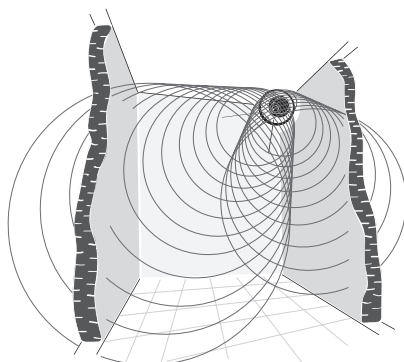



NORMATIVES AND TECHNICAL SPECIFICATIONS

European Machine Directive 2006/42/EC requires the installation of appropriate audible and visual warning devices as an essential safety requirement for the operator in industrial environments.

The majority of the issues examined in the directive relate to design characteristics that assure complete safety of the whole "machinery system". Point 2 of the introduction highlights the ever increasing importance of a signaling device onboard a machine, i.e.:

"The machinery sector is an important part of the engineering industry and is one of the industrial mainstays of the Community economy. The social cost of the large number of accidents caused directly by the use of machinery can be reduced by inherently safe design and construction of machinery and by proper installation and maintenance".

Sirena has concentrated on the development of signaling equipment suitable for all the safety conditions that the system provides for, not forgetting our philosophy that has always accompanied our "modus operandi" that is... "an alarm signal must always be able to reveal an imminent danger and a dangerous situation".

ACOUSTIC RANGE

Current International standards for safety require the installation of an audible warning device in order to attract the attention of the operator and to indicate a dangerous or emergency situation.

The suitability of an audible alarm for a specific application is determined by the following factors:

- sound output Decibel (dB)
- sound frequency Hertz (Hz)
- the distance between the audible warning device and the operator
- the existing environmental noise

International safety standards have established that the dB level must be 15dB higher than that of the ambient noise and the siren must, however, have a minimum sound output of 65dB.

The sound frequency of the siren, at the point where the sound output is greatest, must differ as much as possible to the frequency of the ambient noise. Sound frequency, however, must be between 300 and 3000 Hz.

To put these rules into force the use of a phonometer is necessary - an instrument that allows the measurement of the dB and Hz frequency levels - and by consulting the technical data of the various types of audible signals in the Sirena catalogue. The sound output dB level of Sirena's audible warning devices are accurately measured in an anechoic testing chamber at a distance of one meter from the axis of the device, the ratings given in the catalogue refer to maximum sound levels.

To select the correct product to be installed, the sound spectrum of the siren must be superimposed upon the sound spectrum of the ambient noise. The differential dB level and the differential frequencies Hz are therefore immediately recognized.

DECIBEL dB(1m) - SOUND LEVEL MEASUREMENT

The sound level is measured in Decibels. Exact data relating to the distance the sound can reach are not available as the following factors can influence significantly the sound intensity: type of sound, wind speed and direction, humidity, fog and rain. The table in the page beside shows theoretical values.



NORMES ET SPECIFICATIONS TECHNIQUES

La **Directive Européenne Machines 2006/42/CE** rend obligatoire à bord des machines l'installation de dispositifs de signalisation acoustique et lumineuse adéquats, essentiels à la sécurité des opérateurs dans l'environnement industriel.

Une grande partie des points traités dans la directive concerne l'étude relative à la mise en sécurité global du "système machine". Le point 2 de l'introduction met en valeur, l'importance croissante de la signalisation à bord de machine :

"Le secteur des machines constitue une partie importante du secteur de la mécanique et est l'un des piliers industriels de l'économie communautaire. Le coût dû au nombre important d'accidents provoqués par l'utilisation des machines peut être réduit en intégrant la sécurité dans le développement et la construction des machines, mais aussi en effectuant une installation et une manutention correctes".

Sirena a concentré son attention sur le développement de la signalisation adaptée pour les différents stades de sécurité requis, et sans abandonner une philosophie qui accompagne notre modus operandi de toujours, en particulier : "Un signal doit toujours être en condition d'avertir d'un danger imminent et doit indiquer le début et la durée d'une situation dangereuse".

GAMME ACOUSTIQUE

Les normes internationales en matière de sécurité dans l'industrie imposent l'installation de dispositifs de signalisation acoustique adéquats qui doivent être mis en fonction en cas d'alarme de danger ou d'urgence, afin d'assurer la sécurité du personnel intervenant dans les processus modernes de production.

Les variables du signal acoustique fixés par les normes internationales pour la sécurité sont :

- le niveau de pression acoustique mesuré en Décibel (dB)
- la gamme de fréquence du son émis en Hertz (Hz)
- la distance entre le dispositif et le destinataire
- la présence d'autres sources de bruit

Le niveau en dB doit être au moins supérieur de 15 dB au niveau du bruit ambiant et de toute façon supérieur à 65 dB. Le signal acoustique doit se différencier au maximum de la plage de fréquence dans lequel le bruit ambiant est le plus fort et, de toute façon, doit être compris entre 300 et 3000 Hz.

Pour appliquer ces règles il est indispensable de mesurer à l'aide d'un sonomètre (outil qui permet de détecter le niveau en dB et la fréquence en Hz) et de se référer aux données techniques indiquées dans notre catalogue concernant chaque modèle de dispositif acoustique de notre production. Les données relatives au niveau acoustique de nos avertisseurs indiquent le niveau de pression acoustique dB mesuré en chambre anéchoïque à la distance d'un mètre sur l'axe de l'avertisseur. Les données indiquées sur notre catalogue se réfèrent au niveau acoustique maximal.

Pour une installation correcte et efficace, il suffit de superposer idéalement le spectre sonore de l'appareil de signalisation choisi au spectre sonore du bruit ambiant ; on pourra ainsi apprécier immédiatement le différentiel du niveau de pression acoustique en dB et le différentiel relatif de la gamme de fréquence en Hz.

DECIBEL dB(1m) - UNITE DE MESURE DU NIVEAU SONORE

Le niveau sonore peut être mesuré en Décibel mais pour la portée il n'existe pas d'indications valables. Plusieurs facteurs inconnus influencent cette valeur : type de son, vitesse et direction du vent, humidité de l'air, brouillard et pluie, pour en mentionner quelques-uns. L'illustration à côté, qui indique le rayon d'action, a seulement une valeur théorique.

SOGLIA DI UDIBILITÀ HEARING THRESHOLD SEUIL AUDIBLE

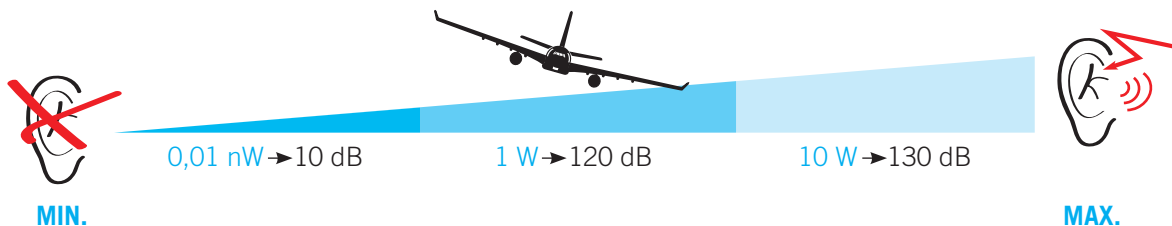

Quanto forte sia un segnale resta sempre relativo (vedere tabella). Un aumento di 3 dB viene percepito dall'orecchio umano come un raddoppiamento del livello sonoro.

🇬🇧 The sound perception of an audible signal, therefore, always depends on the application conditions (see table). An increase in sound of 3 dB is heard as a double sound level.

🇫🇷 L'intensité d'un signal est toujours relative (voir tableau). Une augmentation de 3 dB est perçue par l'oreille comme le double du niveau sonore.

m	dB (A)																											
1	65	70	75	80	85	90	92	94	96	98	100	102	104	106	108	110	112	114	116	118	120	122	124	126	128	130		
2	59	64	69	74	79	84	86	88	90	92	94	96	98	100	102	104	106	108	110	112	114	116	118	120	122	124		
3	55	60	65	70	75	80	82	84	86	88	90	92	94	96	98	100	102	104	106	108	110	112	114	116	118	120		
5	51	56	61	66	71	76	78	80	82	84	86	88	90	92	94	96	98	100	102	104	106	108	110	112	114	116		
10	45	50	55	60	65	70	72	74	76	78	80	82	84	86	88	90	92	94	96	98	100	102	104	106	108	110		
20	39	44	49	54	59	64	66	68	70	72	74	76	78	80	82	84	86	88	90	92	94	96	98	100	102	104		
30	35	40	45	50	55	60	62	64	66	68	70	72	74	76	78	80	82	84	86	88	90	92	94	96	98	100		
50	=	36	41	46	51	56	58	60	62	64	66	68	70	72	74	76	78	80	82	84	86	88	90	92	94	96		
100		=	=	40	45	50	52	54	56	58	60	62	64	66	68	70	72	74	76	78	80	82	84	86	88	90		
200				=	39	44	46	48	50	52	54	56	58	60	62	64	66	68	70	72	74	76	78	80	82	84		
300				=	40	42	44	46	48	50	52	54	56	58	60	62	64	66	68	70	72	74	76	78	80			
500				=	38	40	42	44	46	48	50	52	54	56	58	60	62	64	66	68	70	72	74	76				
1000				=	=	=	38	40	42	44	46	48	50	52	54	56	58	60	62	64	66	68	70					
2000							=	=	=	38	40	42	44	46	48	50	52	54	56	58	60	62	64					
3000										=	=	38	40	42	44	46	48	50	52	54	56	58	60					
5000													=	=	38	40	42	44	46	48	50	52	54	56				

LINEA LUMINOSA

I segnali luminosi, attraverso le loro due variabili dell'intensità luminosa (flusso luminoso emesso da una sorgente puntiforme in una determinata direzione) e del colore, sono in grado di creare un linguaggio in codice per l'invio di informazioni dalla macchina, dalla linea e dal reparto agli operatori.

L'intensità luminosa del segnalatore varia al variare della distanza tra punto di osservazione e osservatore; varia secondo le diverse tipologie di lenti del diffusore e secondo il filtro luminoso colorato interposto tra sorgente luminosa e punto d'osservazione.

L'intensità luminosa dei nostri segnalatori è misurata in Cd(p) (Candele di picco) in camera fotometrica. Le Cd(p) rappresentano un valore assoluto che per essere tradotto nella pratica dell'installazione dei dispositivi deve tenere in considerazione il filtro colorato della cupola. Il dato delle candele di picco è misurato con cupola neutra che lascia passare il 100% della luce, la diminuzione dell'intensità luminosa è progressiva se i filtri sono colorati.

Il buon senso sull'impiego dei dispositivi luminosi in ambienti industriali, richiede che la loro intensità luminosa sia sempre superiore sia nei casi di segnali di pericolo, che nei casi di segnali di emergenza, rispetto al livello di luminosità ambientale. Quest'ultimo parametro può essere facilmente rilevato attraverso l'impiego di un apposito strumento denominato LUXMETRO.

È fondamentale concentrare l'intensità luminosa e direzionarla verso l'area dell'operatore per ottenere una buona segnalazione.

L'intensità luminosa di una sorgente luminosa non è legata unicamente alla potenza della sua lampadina filtrata dalla cupola colorata. Nei segnalatori luminosi si ricorre spesso alle ottiche secondarie per amplificare l'intensità.

Per ottiche secondarie si intendono lenti e riflettori che, integrati in alcuni casi alla cupola stessa, rendono la segnalazione intensa e direzionale.

Le segnalazioni luminose (fisse, rotanti o lampeggianti) sfruttano sorgenti di diverse tipologie, ottenendo l'effetto desiderato mediante:

- l'accensione e lo spegnimento ciclico di una lampadina a filamento
- la rotazione orbitale periodica di una parabola riflettente intorno all'asse della lampadina sempre accesa
- il lampo ciclico di una lampadina a scarica pilotata da un circuito elettronico
- l'accensione e lo spegnimento ciclico di un LED pilotato da un circuito elettronico.



LUMINOUS RANGE

Visual warning signals, thanks to their luminous intensity (measure of the wavelength-weighted power emitted by a light source in a particular direction per unit solid angle) and the different colors, create a language code that allows communication between machines and operators.

The luminous intensity varies according to: the distance between the luminous point and the observer, the type of lens and the colour of the dome.

The light intensity of Sirena warning signals is measured in Cd(p) in a photometric chamber. The Cd(p) represents the peak luminous intensity using a transparent dome that allows 100% brightness. The light output is reduced according to the color of the dome.

The correct use of visual signals in industrial environments requires that the light output is always greater than that of the ambient light level with regard to both warning and emergency signaling. The ambient light level must therefore be determined and is obtained by means of a LUXOMETER.

It is therefore fundamental to concentrate the light intensity towards the operator to obtain efficient signaling.

The light emitted through the coloured dome does not depend only on the power of the bulb installed. It is often necessary to use secondary optics to amplify the light intensity. Secondary optics are lenses and reflectors that in some cases when added to the existing dome amplify the intensity and allow directional light.

Light signals (steady, rotating or flashing) have different types of light sources and are obtained as follows:

- the on/off cycle of the incandescent bulb
- periodic rotation of a parabolic mirror around the axis of a continuously lit bulb
- the cyclic flash of a xenon discharge tube driven by an electronic circuit
- the on/off cycle of a LED driven by an electronic circuit.



GAMME LUMINEUSE

Les signaux lumineux, à travers leurs deux variables d'intensité lumineuse (flux lumineux émis par une source en forme de point vers une direction déterminée) et de couleur, sont à même de créer un langage en code pour l'envoi d'informations de la machine à l'opérateur.

L'intensité lumineuse de l'avertisseur varie selon le changement de la distance entre le point d'observation et l'observateur, selon les différents types de lentille du diffuseur et enfin selon le filtre lumineux coloré interposé entre la source lumineuse et le point d'observation.

L'intensité lumineuse de nos avertisseurs est mesurée en Cd(p) (Candela de pic) dans une chambre photométrique. Les Candelas de pic Cd(p) représentent une valeur absolue qui, pour être traduite lors de l'installation des dispositifs, doit tenir compte de la distance et du filtre coloré du dôme. La donnée des Candelas de pic est mesurée avec un dôme incolore qui permet le passage de 100% de la lumière ; la diminution de l'intensité lumineuse est progressive si les filtres sont colorés.

Le bon sens sur l'emploi des dispositifs lumineux dans les milieux industriels, demande une luminosité toujours supérieure, soit pour les signaux d'avertissement soit pour les signaux d'urgence, au niveau ambiant. Ce dernier paramètre peut être facilement relevé par un appareil spécifique nommé LUXMETRE.

Concentrer donc l'intensité lumineuse en direction de l'opérateur est fondamental pour obtenir une bonne signalisation.

L'intensité lumineuse d'une source de lumière n'est pas uniquement liée à la puissance de l'ampoule filtrée par le dôme coloré. Dans les signalisations lumineuses il est souvent fait recours aux optiques secondaires pour amplifier l'intensité. Par optiques secondaires on entend lentilles ou réflecteurs qui, parfois intégrés au dôme, rendent le signal plus intense et directionnel.

Les signalisations lumineuses (fixes, tournantes, clignotantes) utilisent des sources des types différentes, pour obtenir l'effet désiré par :

- l'allumage et l'extinction cyclique d'une ampoule à incandescence
- la rotation orbitale périodique d'une parabole réfléchissante autour de l'axe de l'ampoule toujours allumée
- l'éclat cyclique d'une ampoule à décharge pilotée par un circuit électronique
- l'allumage et l'extinction cyclique d'une LED pilotée par un circuit électronique.



LAMPADA AD INCANDESCENZA

È la tecnologia più obsoleta attualmente presente sul mercato. I segnalatori utilizzano la lampada a filamento (tungsteno) ed un circuito supplementare per i lampeggianti.



INCANDESCENT BULBS

The most traditional technology on the market. The beacons are fitted with a filament (tungsten) bulb and an additional circuit for the flash function.



AMPOULE A INCANDESCENCE

C'est la technologie plus obsolète du marché. Les signalisations utilisent l'ampoule à incandescence (tungstène) et un circuit supplémentaire pour les clignotants.



LAMPADA ALOGENA

Particolare lampada ad incandescenza che utilizza Iodio, Krypton e gas Xeno per portare la temperatura del colore a 3000°K ed aumentare l'efficienza luminosa. Normalmente, a parità di Watt assorbiti, la lampada alogena ha un'emissione luminosa superiore alla lampada ad incandescenza tradizionale.



HALOGEN BULBS

Particular incandescent bulb that uses Iodine, Krypton and Xenon gas to bring the temperature of the colour to 3000°K and increases the light efficiency. The halogen bulb has a greater light output than the traditional incandescent bulb with equal Watt consumption.



AMPOULE HALOGENE

Type particulier d'ampoule à incandescence qui utilise l'Iode, le Krypton et le gaz Xénon pour porter la température de la couleur à 3000°K et augmenter l'efficacité lumineuse. Normalement à parité de Watts absorbés, l'ampoule halogène a une émission lumineuse supérieure à la lampe à incandescence traditionnelle.



LAMPADA A SCARICA (XENON)

Tipo di lampada basata sull'emissione di radiazione elettromagnetica da parte di un plasma di gas ionizzato, ottenuta per mezzo di una scarica elettrica attraverso il gas stesso (alto voltaggio). La temperatura del colore è pari a 6000°K, con innalzamento dell'efficienza luminosa.



XENON DISCHARGE BULBS

This bulb is based on the emission of electromagnetic radiation from an ionized gas plasma, obtained by an electrical discharge by means of the same gas (high voltage). The colour temperature is equal to 6000 °K with increased light efficiency.



TUBE A DECHARGE (XENON)

Type d'ampoule basée sur l'émission d'une radiation électromagnétique par un plasma de gaz ionisé, obtenue grâce à une décharge électrique au travers du gaz (haut voltage). La température de la couleur est de 6000°K, provoquant une augmentation de l'efficiencia lumineuse.



LED

Il termine "LED" è un acronimo che sta per "Light Emitting Diode", ovvero "diodo che emette luce".



LED

LED stands for Light Emitting Diode that is a semiconductor light source.



LED

Le terme "LED" est l'acronyme de "Light Emitting Diode" c'est-à-dire "Diode émettant une lumière".

I LED emettono luce fredda e possono lampeggiare a frequenze molto alte, superiori al Mhz.

La tecnologia LED può garantire numerosi vantaggi:

- diminuzione della quantità di "materia" utilizzata per la loro produzione e conseguente riduzione di ingombri e pesi, determinando un'agevolazione nell'approvvigionamento, stoccaggio e trasporto dei materiali
- ridotto contenuto di sostanze tossiche o nocive

- ridotta emissione di raggi UV e IR
- basso consumo di energia
- durata pressochè illimitata (se paragonata alle altre tecnologie) grazie ad una notevole riduzione delle temperature di esercizio e dei danni provocati dalle vibrazioni delle macchine
- definizione ottica eccellente



LEDs emit a cold light and can flash at a very high frequency (over Mhz).

LED technology guarantees numerous advantages:

- a reduction in the quantity of "material" used for their production with respect to the traditional products, resulting therefore in a decrease in volume and weight, that facilitates supplies, stocks and transport of the material as well as in industrial production
- less content of toxic or harmful substances
- less UV and IR rays
- low power consumption
- practically unlimited life (if compared with other types) thanks to significant reduction in the operating temperature and damage caused by vibrations
- excellent optical definition



Les LED émettent une lumière froide, et peuvent clignoter à très haute fréquence, supérieure au Mhz.

La technologie LED peut garantir de nombreux avantages :

- Diminution de la quantité de "matière" utilisée pour leur production, par rapport aux produits traditionnels comportant donc une diminution des encombrements, facilité d'approvisionnement, de stockage et de transport des matières dans la production industrielle
- Réduction des substances toxiques et nocives
- Réduction des émissions des rayons UV et IR
- Faible consommation d'énergie
- Durée pratiquement illimitée (en comparaison avec les autres technologies) grâce à la réduction de la température d'utilisation et des dommages provoqués par les vibrations des machines
- Définition optique excellente.



MLINE

Un concept... infinite soluzioni
One concept... endless solutions
Un concept... des solutions infinies



SIRENA



INDICE / INDEX / INDEX

96 Benvenuti nel mondo **MLINE**
Welcome to the **MLINE** world
Bienvenue dans le monde **MLINE**

96 Tecnologia multicanale
Multichannel technology
Technologie multicanal

98 Un concept... infinite soluzioni
One concept... endless solutions
Un concept... des solutions infinies

100 Basi a scelta in quattro colori
Four base color options
Quatre couleurs de base

102 Gamma S
S range
Gamme S

104 FLR S
105 SLR S
106 SIR-E S
107 SIR-E MAX
108 SIR-E LED S
109 SIR-E LED MAX
110 XLF S
111 XLF RGB
112 XLF RGA



114 Gamma FA
FA range
Gamme FA

116 SIR-E FA
117 SIR-E LED FA
118 SLR FA
119 XLF FA



120 Basi
Bases
Bases



122 Accessori
Accessories
Accessoires

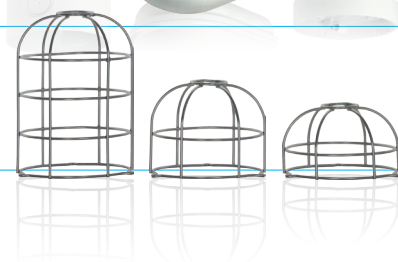

123 Certificazioni
Certifications
Certifications

BENVENUTI NEL MONDO **M**LINE

MLINE nasce da un nuovo ed esclusivo concetto modulare sviluppato da Sirena che porta i dispositivi di segnalazione ad un livello del tutto nuovo, permettendo agli utenti di avere un prodotto "creato su misura" per ogni tipo di applicazione.

Le altissime prestazioni ottiche dei dispositivi luminosi, legate all'elevato output delle componenti acustiche collocano **M**LINE al top della gamma, rendendola adatta alle soluzioni applicative più complesse.

Dopo una serie di rigorosi test, **M**LINE ha ottenuto l'indice di protezione IP66/65, un traguardo notevole, specialmente per i dispositivi acustici, che rende questa linea ideale anche per applicazioni esterne. Inoltre, **M**LINE è certificata UL con environmental rating 3R per i dispositivi acustici e 4X per i dispositivi luminosi.

MLINE è stata realizzata con un esclusivo sistema modulare che permette ad ognuna delle nove **cupole** di essere montata su ciascuna delle sei **basi**, riducendo drasticamente il numero dei componenti e lo stock, consentendo ai professionisti del settore di essere più reattivi alle mutevoli esigenze di mercato.

La tecnologia LED permette una migliore resistenza alle vibrazioni, una vita maggiore del prodotto oltre che un basso consumo, fornendo zero manutenzione e riducendo drasticamente i costi operativi.

Inoltre, l'innovativo design dei prodotti **M**LINE fa sì che possano avere un ruolo chiave nelle applicazioni commerciali e civili, oltre che nelle più tradizionali applicazioni industriali.

TECNOLOGIA MULTICANALE MULTICHANNEL TECHNOLOGY TECHNOLOGIE MULTICANAL



CUPOLE / DOMES / DÔMES

Novi dispositivi multifunzione basati su tecnologia multicanale che consente l'attivazione di ogni funzione del dispositivo tramite contatti elettrici indipendenti, creando livelli di allarme multipli con un solo dispositivo.

🇬🇧 A range of nine multifunctional domes based on an innovative multichannel technology allowing each function of the device to be controlled via independent electrical contact, creating different levels of alarm with one single device.

🇫🇷 Neuf dispositifs multifonctionnels basés sur une technologie multicanal qui permet de gérer chaque fonction du dispositif par connexions électriques indépendantes, créant différents niveaux d'alarme avec un seul produit.



BASI / BASES / BASES

Sei forme disponibili con tre tipologie di voltaggio (12/24V ACDC, 40/80V ACDC, 120/240V AC) e quattro colori a scelta, offrendo agli utenti un totale di 86 diverse opzioni: la soluzione perfetta per ogni tipo di applicazione.

🇬🇧 Six different base shapes with three ranges of voltages (12/24V ACDC, 40/80V ACDC, 120/240V AC) and four color choices, offering a total of 86 different options: a perfect fit for each application.

🇫🇷 Six versions disponibles avec trois tensions différentes (12/24V ACDC, 40/80V ACDC, 120/240V AC) et quatre couleurs, donnant aux utilisateurs un total de 86 options différentes : une solution parfaite pour tous types d'application.



WELCOME TO THE **MLINE** WORLD

MLINE is a new and unique modular concept developed to take signaling devices to a whole new level, delivering users with a customized product tailored for each specific application.

The high optical performance of the beacons, together with the strong sound output of the sounders make **MLINE** a high-end range destined to the most demanding applications.

After a series of rigorous tests, **MLINE** has been granted IP66/65 status, a very high rating, especially for sounders, making this product ideal also for outdoor applications. Furthermore **MLINE** is UL approved with environmental ratings of 3R for sounders and 4X for beacons.

MLINE has been engineered with an exclusive modular concept allowing each of the nine **domes** to be mounted on any of the six **bases**, drastically reducing the number of parts stocked, granting Professionals with a more reactive response to the market needs.

The all-round LED technology allows a better resistance to vibrations, longer life product and lower consumption, delivering a virtually zero maintenance range and drastically reducing operating costs.

The innovative design, together with four base color options, make **MLINE** a key player also in Commercial and Civil applications besides more traditional Industrial applications.



BIENVENUE DANS LE **MLINE** MONDE

MLINE est née d'un concept modulaire nouveau et exclusif développé par Sirena qui élève les dispositifs de signalisation à un niveau tout à fait nouveau, permettant aux utilisateurs d'avoir un produit "créé sur mesure" pour tous types d'applications.

Les très hautes prestations optiques des dispositifs lumineux, associé à un niveau acoustique élevé des sirènes, placent **MLINE** au top de la gamme, adaptée aux solutions applicatives les plus complexes.

Après une série de tests rigoureux, la gamme **MLINE** a obtenu l'indice IP 66/65, un indice de protection élevé, surtout pour les dispositifs acoustiques, qui la rend adaptée aussi pour un usage à l'extérieur.

MLINE a obtenu la certification UL, degré de protection 3R, pour les dispositifs acoustiques, et 4X pour les dispositifs lumineux.

MLINE a été réalisée en employant un système modulaire exclusif qui permet à chacun des neuf **dômes** d'être monté sur chacune des six **bases**, permettant de réduire le stock de produits et de composants et ainsi être plus réactif face au marché toujours changeant.

La technologie LED permet une grande résistance aux vibrations, augmente la durée de vie du produit, en offrant un entretien quasi-nul et la réduction des coûts de fonctionnement.

De plus, le design innovateur des produits **MLINE** permet leurs installations dans n'importe quel type d'utilisation, sans parler des applications industrielles plus traditionnelles.



Ciascuna delle cupole **MLINE** può essere abbinata su ciascuna delle basi con un semplice meccanismo a scatto che permette facili e sicure installazioni anche negli ambienti più difficili.

 **MLINE** domes and bases can be matched together with an easy snap-on technology allowing an easy and safe installation procedure also in the most challenging environments.

 Chaque dôme **MLINE** peut être monté sur chacune base par le moyen d'un mécanisme de fixation avec fermoir à cliquet, qui permet une installation facile, même dans les lieux les plus difficiles

UN CONCEPT... ONE CONCEPT... UN CONCEPT...

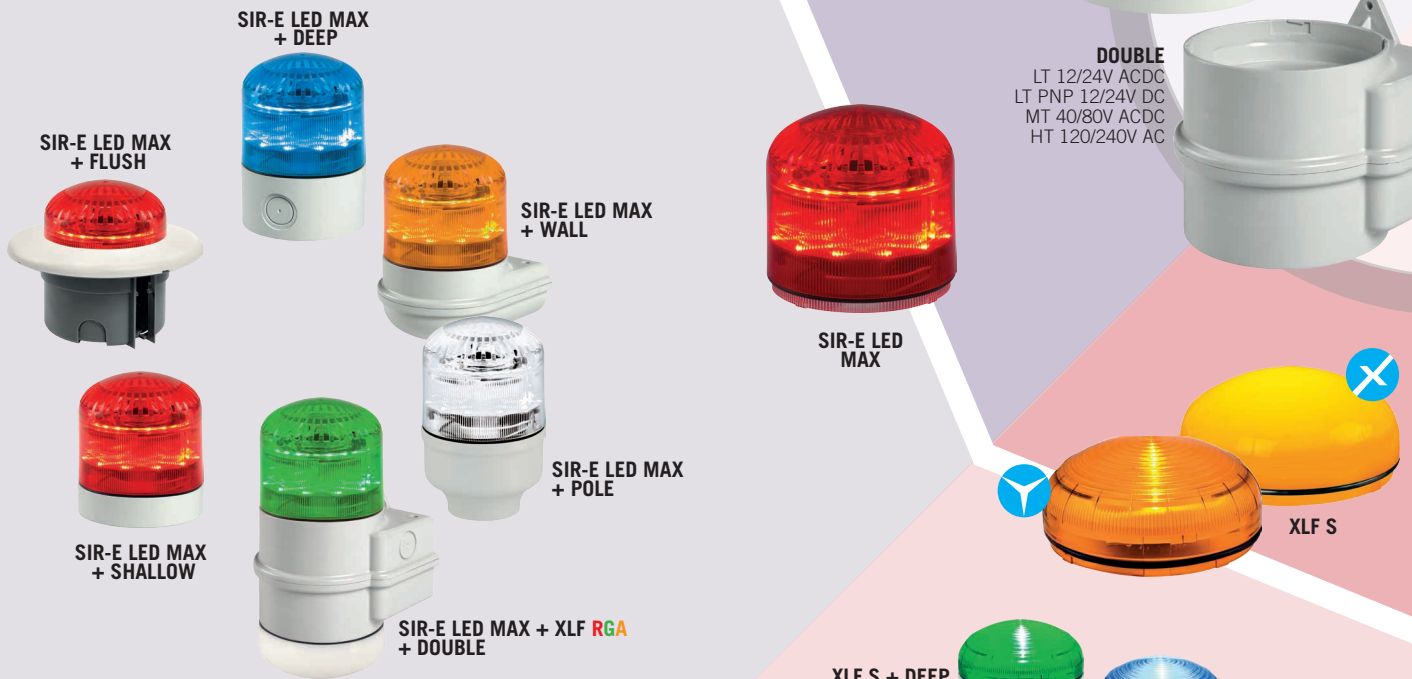
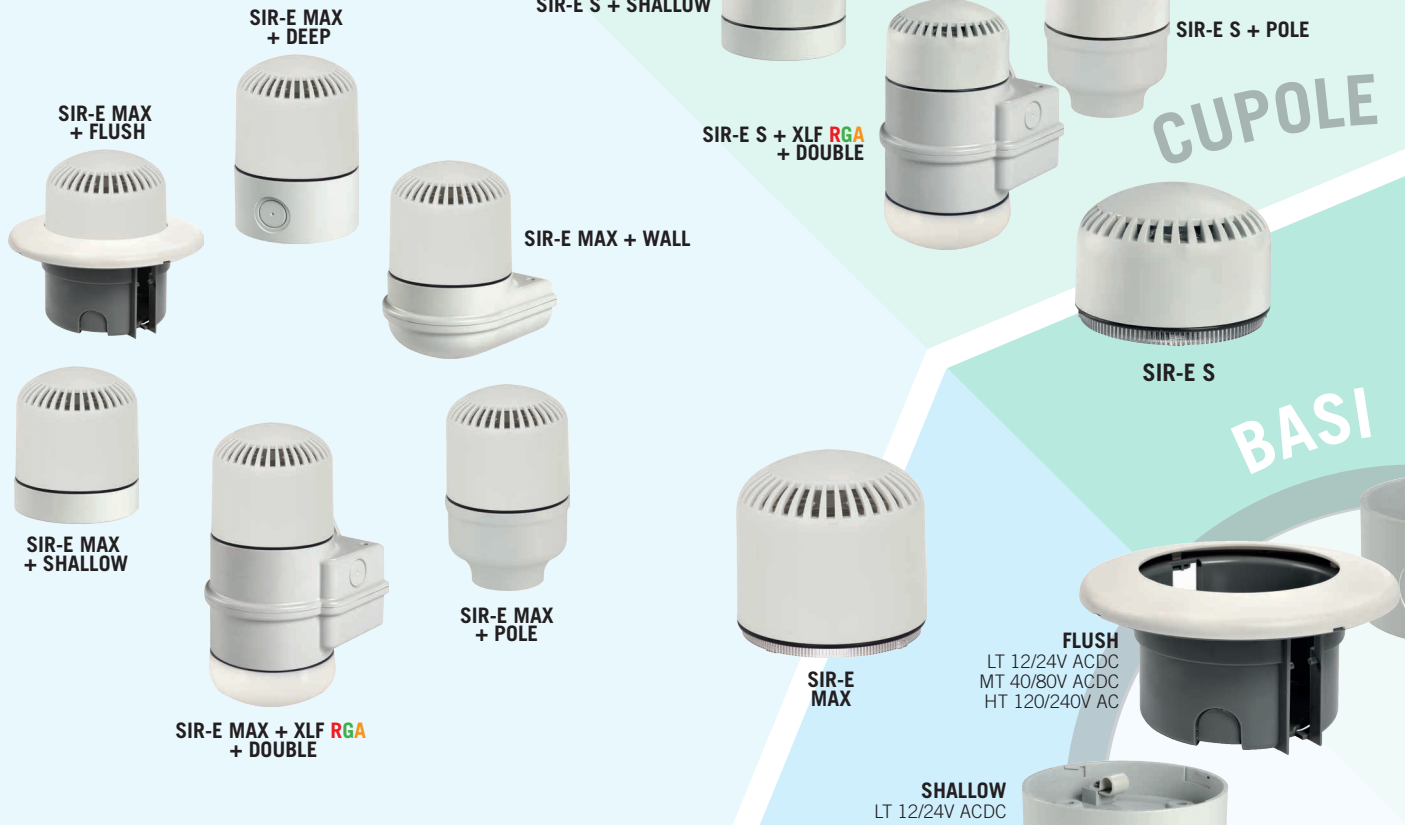

Le basi sono disponibili in / All bases available in / Les bases sont disponibles en :

aiIGRAY	Grigio Chiaro / Light Gray / Gris Clair	RAL 7035
aiBLACK	Nero / Black / Noir	RAL 9005
aiRED	Rosso / Red / Rouge	RAL 3000
aiWHITE	Bianco / White / Blanc	RAL 9003

La grafica mostra gli esempi di combinazione **aiIGRAY**.
I prodotti XLF RGA e XLF RGB sono illustrati accesi e spenti.

Chart above showing **aiIGRAY** combinations examples.
The products XLF RGA and XLF RGB are shown on and off.

Le graphique montre les exemples de combinaisons **aiIGRAY**.
Les produits XLF RGA et XLF RGB sont montrés allumés et éteints.

DOMES

SIR-E LED S + FLUSH

SIR-E LED S + DEEP

SIR-E LED S + WALL

SIR-E LED S + SHALLOW

SIR-E LED S + POLE

SIR-E LED S + SIR-E S + DOUBLE



SIR-E LED S

BASES

DEEP

LT 12/24V ACDC
LT PNP 12/24V DC
MT 40/80V ACDC
HT 120/240V AC



WALL

LT 12/24V ACDC
LT PNP 12/24V DC
MT 40/80V ACDC
HT 120/240V AC



POLE

LT 12/24V ACDC
LT PNP 12/24V DC
MT 40/80V ACDC
HT 120/240V AC



FLR S



SLR S



XLF RGA
XLF RGB

FLR S + DEEP

FLR S + FLUSH



FLR S + WALL



FLR S + SHALLOW



FLR S + POLE

FLR S + SIR-E S + DOUBLE

SLR S + DEEP



SLR S + FLUSH



SLR S + WALL



SLR S + SHALLOW



SLR S + POLE

SLR S + SIR-E S + DOUBLE

XLF RGA + FLUSH

XLF RGB + DEEP

XLF RGA + WALL



XLF RGB + SHALLOW



XLF RGA + SIR-E S + DOUBLE



XLF RGA + POLE

...INFINITE SOLUZIONI
...ENDLESS SOLUTIONS
...DES SOLUTIONS INFINIES

BASI A SCELTA IN QUATTRO COLORI CUSTOMIZZATE PER OGNI APPLICAZIONE

La gamma modulare **MLINE** consente di applicare le cupole multifunzione su qualsiasi base. Le applicazioni dei prodotti **MLINE** sono infinite, la qualità dei prodotti, unita alla tecnologia multifunzionale e modulare, fanno sì che questi dispositivi innovativi possano essere utilizzati in applicazioni che vanno dall'industriale al civile, passando per l'antincendio ed il commerciale.

Sirena, cosciente del fatto che ogni settore di applicazione deve tener conto di regole ed usi ben precisi, ha introdotto quattro gamme di colore per consentire all'utilizzatore finale ed ai professionisti del settore di disporre sempre di un prodotto altamente customizzato per l'applicazione.

I prodotti **MLINE** nascono per adattarsi alle esigenze degli utilizzatori finali, non viceversa...

Benvenuti nel mondo **MLINE**...



aIIGRAY Industriale / Industrial / Industrielle

La gamma **aIIGRAY** nasce per soddisfare le richieste del settore industriale. La sua colorazione Grigio Chiaro (RAL 7035) consente di installare i prodotti **MLINE** rimanendo in sintonia con gli altri componenti dell'impianto, come canaline, scatole di derivazione e quadri elettrici, donando un look professionale all'impianto ed aumentando il valore aggiunto offerto dal professionista.

🇬🇧 The **aIIGRAY** range has been developed to fulfill the Industrial sector requirements. Its light gray color (RAL 7035) allows to install **MLINE** products without interfering with the rest of the installation, remaining in line with the common coloring of connection boxes, enclosures, panels, etc. allowing Professionals to deliver an added value to their job.

🇫🇷 La gamme **aIIGRAY** est née pour satisfaire les demandes du secteur industriel. Sa couleur gris clair (RAL 7035) permet d'installer les produits **MLINE** en restant en harmonie avec les autres composants de l'installation, comme les canaux de câblage, les boîtes de dérivation et les cadres électriques, conférant un look professionnel à l'installation, un aspect destiné à augmenter la valeur ajoutée offerte par le professionnel.



aIIBLACK Industriale / Industrial / Industrielle

La gamma **aIIBLACK** consente di soddisfare le richieste più particolari del settore industriale dove la colorazione nera è prevista. Il Nero (RAL 9005) consente di non turbare l'estetica dell'impianto quando questo è stato impostato con una colorazione nera di partenza. Questa gamma è particolarmente indicata anche per il settore dei Costruttori di Macchine alla ricerca di un dispositivo unico, elegante e funzionale che permetta di garantire il giusto valore ai loro importanti progetti.

🇬🇧 The **aIIBLACK** range allows to satisfy all those requests from the Industrial sector where black color (RAL 9005) is required. This range allows preserving the aesthetic of existing installations where black color is present. **aIIBLACK** is also the ideal choice for Machine Builders looking for a device that is unique, elegant and functional, preserving the added value of their important projects.

🇫🇷 La gamme **aIIBLACK** permet de satisfaire les demandes plus particulières du secteur industriel où sa couleur noire est prévue. Le Noir (RAL 9005) permet de ne pas perturber l'esthétique de l'installation quand une coloration noire a été imposée à celle-ci dès le début. Cette gamme est particulièrement indiquée aussi pour le secteur des Machines-Outils à la recherche d'un dispositif unique, élégant et fonctionnel qui permette de garantir la valeur juste à leurs projets importants.





FOUR BASE COLOR OPTIONS TAILOR-MADE FOR EACH APPLICATION

MLINE modular range allows installing any of the multifunctional domes on any of the modular bases. The number of applications for **MLINE** are endless; the high quality of the products, together with the modular and multifunctional technology allows these devices to be installed in Industrial, Civil, Fire Alarm and Commercial setups.

At Sirena, we understand that each industry follows precise rules and requirements and for this reason we have created four color lines to better allow end users and Professionals to benefit from highly customizable products, to the point that each device can be considered tailor-made for each application.

MLINE devices are engineered to fulfill end-users requirements, not vice versa...

Welcome to the **MLINE** world...



QUATRE COULEURS DE BASE PERSONNALISEES POUR TOUTE APPLICATION

La gamme modulaire **MLINE** permet d'appliquer les modules multifonctionnels sur n'importe quelle base modulaire. Les applications des produits **MLINE** sont infinies ; la qualité des produits, unie à la technologie multifonctionnelle et modulaire, fait que ces dispositifs innovateurs peuvent être utilisés dans des applications du secteur industriel au secteur civil, en passant par l'anti-incendie et le secteur commercial.

Sirena, consciente du fait que chaque secteur d'application doit tenir en compte des règles et usages bien précis, a introduit quatre gammes de couleurs pour permettre à l'utilisateur final et aux professionnels du secteur de disposer à tout moment d'un produit hautement personnalisé pour l'application.

Les produits Sirena sont nés pour s'adapter aux exigences des utilisateurs finaux, pas vice-versa...

Bienvenue dans le monde **MLINE**...

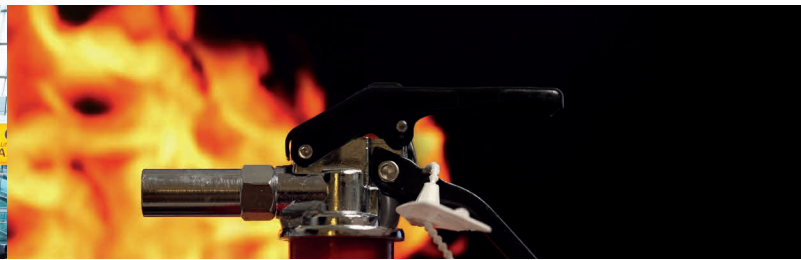

aiIWHITE Civile / Civil / Civile

La gamma **aiIWHITE** è nata per soddisfare le richieste del settore civile e commerciale. Pratica, elegante e multifunzionale, consente di essere installata nel rispetto più totale dell'estetica e della discrezione, garantendo il top delle performance tecniche e mantenendo un look volto a preservare l'importante lavoro svolto dagli studi di progettazione e dagli architetti. In colore Bianco (RAL 9003), questa linea è particolarmente indicata anche per i Costruttori di Macchine che installano il loro prodotto in ambienti civili o commerciali.

🇬🇧 The **aiIWHITE** range has been developed to specifically satisfy aesthetic requirements from the Civil and Commercial installations industry. These devices are pragmatic, elegant and multifunctional, allowing a discrete installation whilst increasing aesthetics and preserving the added values created by architects and design teams. Available in white (RAL 9003), this range is also indicated for Machine Builders that see their products destined to civil or commercial environments.

🇫🇷 La gamme **aiIWHITE** est née pour satisfaire les demandes du secteur civil et commercial. Pratique, élégante et multifonctionnelle, elle permet d'être installée dans le respect le plus total de l'esthétique et de la discrétion, garantissant le top des performances techniques et ayant un look destiné à préserver le travail important développé durant les études de projection et par les architectes. En couleur blanche (RAL 9003), cette ligne est particulièrement indiquée aussi pour les Machines-Outils installant leur produits en milieu civil ou commercial.



aiIRED Antincendio / Fire Alarm / Anti-incendie

La gamma **aiIRED** nasce per soddisfare le richieste della segnalazione antincendio e di evacuazione dove il colore rosso è un requisito spesso richiesto. In Rosso (RAL 3000), la gamma **aiIRED** si sposa con classe ed eleganza al resto dell'impianto di segnalazione garantendo funzionalità ed estetica.

🇬🇧 The **aiIRED** range has been developed to satisfy requirements from the Fire Alarm industry where red color is very often a mandatory requirement. **aiIRED** (RAL 3000) range complements with class and elegance the existing fire alarm installations guaranteeing top functionality and the best aesthetics on the market.

🇫🇷 La gamme **aiIRED** est née pour satisfaire toutes les demandes de signalisation anti-incendie et d'évacuation où la couleur rouge est une exigence souvent requise. Le rouge (RAL 3000) de la gamme **aiIRED** harmonise bien avec classe et élégance du reste de l'installation de signalisation, garantissant fonctionnalité et esthétique.



GAMMA S

La gamma S è la gamma di dispositivi **MLINE** di riferimento. Quando abbiamo iniziato la progettazione della gamma S, il nostro principale obiettivo è stato di sviluppare una gamma semplice che possa essere installata in tutti gli scenari possibili.

Abbiamo progettato le cupole **MLINE** in modo che uno stesso dispositivo possa offrire molteplici funzioni, pur lasciando all'utente finale la possibilità di gestire, in qualsiasi momento, ogni funzione in modo indipendente tramite contatto elettrico. Abbiamo sviluppato le basi **MLINE** in modo che possano soddisfare tutti gli scenari possibili senza che venga compromesso il posizionamento del dispositivo.

Abbiamo creato 9 cupole differenti che consentono di coprire tutte le possibili applicazioni per un numero di variazioni fino a 113 opzioni in totale. Allo stesso tempo abbiamo sviluppato sei forme uniche di basi che permettono il montaggio in qualsiasi circostanza con 4 colori e con 3 voltaggi differenti. Contiamo oggi 86 variazioni di basi differenti offrendo un totale sorprendente di quasi 10000 combinazioni.

Abbiamo fatto questo per consentirvi di non dover mai scendere a compromessi con il vostro lavoro; il nostro obiettivo è creare dispositivi di segnalazione personalizzati sulle vostre necessità. Un professionista qualificato merita di avere un partner che comprenda le sue esigenze e si impegni nel prevedere le aspettative e nel superarle, perché crediamo in cose straordinarie, perché crediamo nel valore aggiunto, perché crediamo che insieme possiamo fare la differenza.

La linea **MLINE** nasce per venire incontro alle esigenze dell'utilizzatore e, come per tutte le linee Sirena, la priorità è quella di offrire un prodotto customizzato per l'applicazione finale, piuttosto che un prodotto standard che spesso si inserisce come compromesso all'interno del progetto. Per questa ragione abbiamo sviluppato 2 tipi di lenti create per applicazioni specifiche secondo l'ambiente circostante.

allCOLOR

La lente **allCOLOR** nasce per un utilizzo standard dove la brillantezza del colore del dispositivo luminoso è la priorità. La lente **allCOLOR** sfrutta la tecnologia colore-su-colore, dove il colore specifico della lente della cupola viene sostenuto da una fonte luminosa a LED con la medesima colorazione. Questo processo consente di ottimizzare le frequenze di emissione e di evitare l'effetto filtro della lente stessa. In questo modo si ottengono colori più vivi e brillanti, idonei a garantire quanto stabilito dalla Direttiva Macchine.

🇬🇧 The **allCOLOR** lens has been developed for Standard applications where the brightness of the device is the main priority. The light output of the colored lens is intensified by using a same-color LED source (color-on-color technology). This process allows optimization of the emission frequencies avoiding the filter effect of the lens. The color is, therefore, more vivid than any standard device guaranteeing compliance with Machine Directive specifications.

🇫🇷 La lentille **allCOLOR** a été développée pour les applications standards où la luminosité de la couleur est la principale priorité. L'intensité lumineuse de la lentille colorée est soutenue à l'aide d'une source lumineuse de même couleur (technologie couleur-sur-couleur). Ce procédé permet d'optimiser les fréquences d'émission en évitant l'effet de filtrage de la lentille. La couleur est donc plus vive et conforme aux spécifications de la directive "Machines".

allCLEAR

La lente **allCLEAR** nasce per l'utilizzo in ambienti ad alta luminosità dove la priorità assoluta è quella di fornire all'operatore un'informazione corretta in merito allo status del macchinario. In ambienti con alta luminosità può verificarsi che la luce ambientale si inserisca nella cupola del dispositivo la quale, se dotata di lente colorata, potrà dare l'impressione di essere accesa o per lo meno potrebbe creare confusione: questa condizione è nota come "effetto phantom". La lente **allCLEAR**, dotata di fonte luminosa colorata e di lente di colore neutro, elimina questa possibilità, essendo di colore bianco/neutro quando spenta e del colore designato una volta accesa.

🇬🇧 The **allCLEAR** lens has been developed for use in brighter environments where the main priority is to give a precise signal regarding machine status to the operator. In very bright environments, the ambient light can cause confusion as to the ON/OFF state of the colored device: this condition is known as "phantom effect". The **allCLEAR** lens, together with a colored LED source, eliminates this possibility. When the device is switched OFF the lens is white/neutral and when it is switched ON the lens lights up according to the LED color of the device.

🇫🇷 La lentille **allCLEAR** a été développée pour une utilisation dans les environnements lumineux où la priorité est de donner un signal précis à l'opérateur à propos du fonctionnement de la machine. Dans les environnements très lumineux, la lumière d'ambiance peut causer de la confusion quant à l'état ON/OFF du dispositif coloré : cette condition est connue comme "effet fantôme". La lentille **allCLEAR**, avec source lumineuse colorée élimine cet effet. Lorsque le dôme est éteint la lentille est blanche/neutre et quand il est allumé, la lentille s'allume en fonction de la couleur de la LED à l'intérieur.





S RANGE

The S range is the most complete range of **MLINE** devices. When we began engineering the S range, our main focus was to develop a simple range of devices that could be yet installed in all possible scenarios.

We engineered **MLINE** domes in a way that multiple functions could be delivered by the same device, yet leaving the control completely independent and controllable by the end user at any time. We engineered **MLINE** bases in a way that all installation scenarios could be covered without having to compromise on the positioning of the device.

We have created 9 different domes that allow to cover all possible applications with a number of variations counting up to 113 options in total. At the same time we developed six shapes of bases to allow mounting **MLINE** under any circumstance: by delivering four type of base color and different voltages we count today 86 types of different bases. This gives you almost 10000 combinations.

We have done this to allow you to never have to compromise with your work; our believe is that we create signaling devices for you, tailored to your needs. As a qualified Professional you deserve to have a Partner that understands your needs and strives to overdeliver, because we believe in extraordinary things, we believe in added value, we believe that together we can make the difference.

Sirena's priority is to offer customers with a customized product tailored to the final application rather than offering a standard product that is often a compromise from what is actually needed. **MLINE** has been engineered specifically to meet the end-user requirements: for this reason we have developed 2 types of lenses engineered for specific applications according to the surrounding environment.



GAMME S

La gamme S est la plus complète parmi les dispositifs de la gamme **MLINE**. Quand nous avons commencé à concevoir celle-ci notre objectif était de développer une gamme simple qui peut être installée dans toutes les situations.

Nous avons conçus les dômes **MLINE** de façon à ce qu'ils puissent offrir de multiples fonctions, tout en laissant un contrôle total, indépendant et permanent à son utilisateur final. Nous avons conçus les bases **MLINE** de façon à ce qu'elles puissent s'adapter à toutes les situations.

Nous avons créé 9 différents dômes adaptés à toutes les applications possibles ce qui nous permet de proposer 113 options d'utilisations.

Dans la même optique, nous avons développé 6 formes de bases permettant une installation en toutes circonstances. Les bases existent en 4 couleurs différentes ainsi qu'en différentes tensions, nous pouvons compter 86 types de bases différentes. C'est ainsi que nous en arrivons à un total de presque 10000 combinaisons.

"UN CONCEPT POUR DES SOLUTIONS INFINIES" est notre slogan et il caractérise parfaitement notre produit **MLINE**.

La priorité de Sirena est d'offrir à ses clients des produits adaptés sur-mesure à leur application plutôt qu'un produit standard qui ne correspond pas toujours à ce dont on a besoin.

MLINE a été spécialement étudié pour les demandes des utilisateurs finaux. C'est pourquoi, nous avons conçu ce produit avec deux types de lentille qui permet une parfaite cohérence entre le produit et l'environnement.

allCOLOR



UTILIZZO STANDARD

Lente colorata con fonte luminosa colorata. La stessa colorazione tra fonte luminosa e cupola permette l'ottimizzazione della frequenza di emissione permettendo di raggiungere una brillantezza unica.

STANDARD USE

Colored lens with colored light source. The use of a colored lens with the same-color light source allows optimization of the emission frequency producing a rich intense light output.

UTILISATION STANDARD

Lentille colorée et source lumineuse colorée. L'utilisation d'une lentille colorée de la même couleur que la source lumineuse permet l'optimisation de la fréquence d'émission produisant une luminosité très intense et riche.

allCLEAR



AMBIENTI CON ALTA LUMINOSITÀ

Lente neutra con fonte luminosa colorata. In ambienti con luminosità molto alta è possibile che la luminosità ambientale stessa illumini la cupola spenta creando problemi nella distinzione tra lo stato ON e OFF del dispositivo (effetto phantom). La cupola con colorazione neutra permette una netta distinzione tra lo status ON e OFF del dispositivo.

USE IN VERY BRIGHT ENVIRONMENTS

Clear lens with colored light source. In very bright environments, it is possible that the ambience brightness lights up the device when it is switched OFF creating problems in distinguishing between the ON and OFF state of the device (phantom effect). The clear lens allows clear distinction between the ON and OFF status of the device.

UTILISATION DANS DES ENVIRONNEMENTS TRÈS LUMINEUX

Lentille incolore transparente avec source lumineuse colorée. Dans les environnements très lumineux, il est possible que la luminosité ambiante éclaire le dispositif quand il est éteint en créant de la difficulté à distinguer l'état entre ON ou OFF du même (effet fantôme). La lentille claire du dispositif permet la bonne distinction entre l'ON ou OFF.

FLR S



Cupole / Domes / Dômes

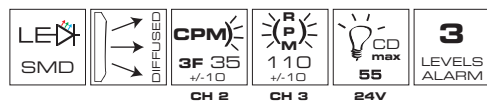

FLR S					
V ACDC	12 ÷ 24	40 ÷ 80	-	-	-
V AC	-	-	120 ÷ 240	-	-
mA	510	360	300	110	70

Può essere installato con
 Can be installed with
 Peut être assemblé à

Basi / Bases

	SHALLOW		DEEP		WALL	
	FLUSH	DOUBLE	FLUSH	DOUBLE	FLUSH	DOUBLE
12/24V ACDC	✓	✓	✓	✓	✓	✓
PNP 12/24V DC	✗	✗	✓	✓	✓	✓
40/80V ACDC	✗	✓	✓	✓	✓	✓
120/240V AC	✗	✓	✓	✓	✓	✓

Vedi sezione BASI a pag. 120
 See BASE Section on page 120
 Voir page 120, section BASES

Codici / Codes

FLR S					
allCOLOR	90351	90352	90353	90354	90139
allCLEAR	90121	90122	90123	90124	

Dispositivo a LED multifunzione, sviluppato con tecnologia multicanale. FLR S permette di gestire tre diversi effetti luminosi (luce fissa, lampeggiante, rotante) tramite contatti elettrici indipendenti.

Disponibile con lente allCOLOR e allCLEAR.

Tensione operativa

A seconda della base utilizzata.

Caratteristiche meccaniche

Polycarbonato autoestinguente ad alta resistenza agli impatti, adatto per utilizzo esterno grazie al grado di protezione IP66, UL TYPE 4X.

Caratteristiche luminose

24x LED Bright, in configurazione 6x4, producono tre effetti luminosi: luce fissa, lampeggiante (triplo flash effetto strobo), rotante (effetto rotante che simula perfettamente le luci rotanti tradizionali pur non avendo componenti mobili, permettendo quindi di accrescere enormemente il ciclo di vita del prodotto).

Disponibile con 2 tipi di lente: allCOLOR (lente colorata con fonte luminosa colorata) e allCLEAR (lente neutra con fonte luminosa colorata), vedi pagina 103.

Certificazioni / Certifications

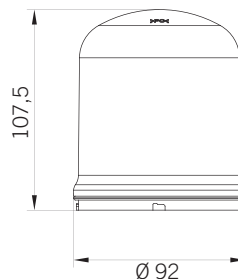

FLR S



Multifunctional LED beacon, developed with a multichannel technology. FLR S allows three separate light effects (steady, rotating, flashing) controllable via independent electric contacts. Available with allCOLOR and allCLEAR lens.

Voltages

According to the installed base.

Mechanical features

Self-extinguishing PC body with high impact resistance, suitable for outdoor applications thanks to the IP66, UL TYPE 4X protection grade.

Optical features

24x Bright LEDs, in a 6x4 configuration, allow three luminous effects: steady light, flashing light (a triple-flash strobe effect), rotating light (a rotating effect perfectly simulating the traditional rotating beacons yet without moving parts, hence enormously enhancing product life time). Available with 2 different lens types, allCOLOR (colored lens with colored light source) and allCLEAR (clear lens with colored light source), see page 103.



Dispositif à LED multifonctionnel, développé avec une technologie multicanale. FLR S permet de gérer trois effets lumineux (lumière fixe, clignotante, tournante) par connexions électriques séparées.

Disponibile avec lentille allCOLOR et allCLEAR.

Tension d'utilisation

En fonction de la base de câblage utilisée.

Caractéristiques mécaniques

Polycarbonate autoextinguible, haute résistance aux chocs, adapté pour une utilisation à l'extérieur grâce au degré de protection IP66, UL TYPE 4X.

Caractéristiques optiques

24x LED Bright, en configuration 6x4, qui produisent trois effets lumineux : lumière fixe, lumière clignotante (triple-flash, effet stroboscopique) effet tournant, qui simule parfaitement les feux tournants traditionnels sans avoir de composants mobiles, permettant ainsi d'augmenter considérablement la durée de vie du produit. Disponible avec deux différents types de lentilles : allCOLOR (lentille colorée et source lumineuse colorée) et allCLEAR (lentille incolore transparente avec source lumineuse colorée), voir page 103.

SLR S



Cupole / Domes / Dômes

PC	50/60 Hz	-30 to +50 C°	IP66	ON	CLASS 2
SELF EXTINGUISHING	LED SMD	DIFFUSED	FPM 1F 110 CH 1	CPM 5F 72 CH 2	FPM RANDOM CH 3
400 max 24V	3 LEVELS ALARM				

SLR S

V ACDC	12 ÷ 24	40 ÷ 80	-	-
V AC			120 ÷ 240	
mA	450	700	800	250
			150	60

Può essere installato con
 Can be installed with
 Peut être assemblé à

Basi / Bases

	SHALLOW		DEEP		WALL	
	FLUSH	DOUBLE	FLUSH	DOUBLE	FLUSH	DOUBLE
12/24V ACDC	✓	✓	✓	✓	✓	✓
PNP 12/24V DC	✗	✗	✓	✓	✓	✓
40/80V ACDC	✗	✓	✓	✓	✓	✓
120/240V AC	✗	✓	✓	✓	✓	✓

Vedi sezione BASI a pag. 120
 See BASE Section on page 120
 Voir page 120, section BASES

Codici / Codes

SLR S

90851	90861	90852	90862	90853	90863	90854
						90856

Dispositivo a LED multifunzione, sviluppato con tecnologia multicanale. SLR S permette di gestire tre diversi effetti luminosi (luce lampeggiante, strobo, random) tramite contatti elettrici indipendenti. SLR S è paragonabile ad una luce con lampada allo Xenon da 6J. Disponibile con lenti allCOLOR e allCLEAR.

Tensione operativa

A seconda della base utilizzata.

Caratteristiche meccaniche

Polycarbonato autoestinguente ad alta resistenza agli impatti, adatto per utilizzo esterno grazie al grado di protezione IP66, UL TYPE 4X.

Caratteristiche luminose

2x LED SuperBright, con lenti di Fresnel interna, producono tre effetti luminosi: luce lampeggiante (flash singolo 1F), effetto stroboscopico 5F, luce random (effetto unico nel suo genere con lampeggio casuale che consente di aumentare la capacità del dispositivo di attirare l'attenzione).

Disponibile con 2 tipi di lenti: allCOLOR (lente colorata con fonte luminosa colorata) e allCLEAR (lente neutra con fonte luminosa colorata), vedi pagina 103.

Certificazioni / Certifications



*Certificazione con utilizzo del collare di sicurezza fornito
 *Certification with the supplied safety collar
 *Certification avec le collier de sécurité fourni

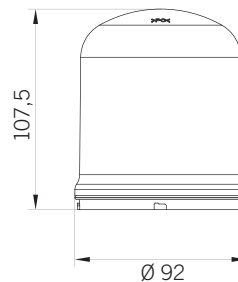

SLR S



Multifunctional LED beacon, developed with a multichannel technology. SLR S allows three separate light effects (flashing, strobe, random) controllable via independent electric contacts. Compared to a traditional flashing beacon with a 6 Joules Xenon discharge tube. Available with allCOLOR and allCLEAR lens.

Voltages

According to the installed base.

Mechanical features

Self-extinguishing PC body with high impact resistance, suitable for outdoor applications thanks to the IP66, UL TYPE 4X protection grade.

Optical features

2x SuperBright LEDs, with inner Fresnel lens, allow three luminous effects: flashing light (single flash 1F), 5F strobe effect, random light (a unique random effect consisting in an uneven flashing pattern, augmenting the ability of catching attention). Available with 2 different lens types, allCOLOR (colored lens with colored light source) and allCLEAR (clear lens with colored light source), see page 103.



Dispositif à LED multifonctionnel, développé avec une technologie multicanale. SLR S permet de gérer trois effets lumineux (lumière clignotante, effet stroboscopique, effet random) par connexions électriques séparées. SLR S est comparable à un feu avec tube à décharge au xénon 6J. Disponible avec lentille allCOLOR et allCLEAR.

Tension d'utilisation

En fonction de la base de câblage utilisée.

Caractéristiques mécaniques

Polycarbonate autoextinguible, haute résistance aux chocs, adapté pour une utilisation à l'extérieur grâce au degré de protection IP66, UL TYPE 4X.

Caractéristiques optiques

2x LED SuperBright avec lentille de Fresnel à l'intérieur, produisent trois effets lumineux: lumière clignotante (simple éclat 1F), effet stroboscopique 5F, effet random (consistant en un clignotement aléatoire, qui permet au dispositif d'augmenter sa capacité d'attirer l'attention). Disponible avec deux différents types de lentille: allCOLOR (lentille colorée et source lumineuse colorée) et allCLEAR (lentille incolore transparente avec source lumineuse colorée) voir page 103.

SIR-E S



SIR-E S

105 dB max

Cupole / Domes / Dômes

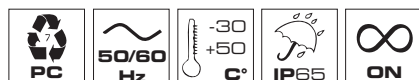

SIR-E S

V ACDC	12 ÷ 24	40 ÷ 80	-	-	-
V AC	-	-	120 ÷ 240	-	-
mA	240	280	150	70	60
dB(A)1m	87 ÷ 105	90 ÷ 105	87 ÷ 105	-	-

Può essere installato con
Can be installed with
Peut être assemblé à

Basi / Bases



	SHALLOW	DEEP	WALL	
12/24V ACDC	✓	✓	✓	✓
PNP 12/24V DC	✗	✗	✓	✓
40/80V ACDC	✗	✓	✓	✓
120/240V AC	✗	✓	✓	✓
	FLUSH	DOUBLE	POLE	

Vedi sezione BASI a pag. 120
See BASE Section on page 120
Voir page 120, section BASES

Codici / Codes

SIR-E S



90360 90357 90358 90359

Sirena elettronica multifunzione, sviluppata con tecnologia multicanale. SIR-E S permette di gestire due diversi livelli di allarme (pre-allarme, allarme) attivabili tramite contatti elettrici indipendenti. Multisuono: 64 suoni disponibili (tipologia industriale, civile, antincendio).

Tensione operativa

A seconda della base utilizzata.

Caratteristiche meccaniche

Polycarbonato autoestinguente ad alta resistenza agli impatti, adatto per utilizzo esterno grazie al grado di protezione IP65, UL TYPE 3R.

Caratteristiche acustiche

Buzzer elettromagnetico con volume regolabile (Min. 75 dB - Max. 105 dB) che produce:
- PRE-ALLARME, un potente suono elettronico di max. 105 dB (suono selezionabile via dip-switch "A" tra 32 suoni disponibili)
- ALLARME, un potente suono elettronico di max. 105 dB (suono selezionabile via dip-switch "B" tra 32 suoni disponibili).

Certificazioni / Certifications

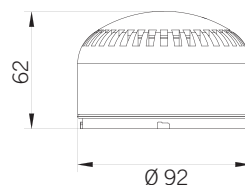

SIR-E S



Multifunctional electronic siren developed with a multichannel technology. SIR-E S allows two separate levels of alarm (pre-alarm, alarm) controllable via independent electric contacts. Multitone: 64 tones available (including industrial, civil and fire alarm tones).

Voltages

According to the installed base.

Mechanical features

Self-extinguishing PC body with high impact resistance, suitable for outdoor applications thanks to the IP65, UL TYPE 3R protection grade.

Acoustic features

Electromagnetic buzzer with adjustable volume (Min. 75 dB - Max. 105 dB) producing:
- PRE-ALARM, a powerful up to 105 dB electronic tone (selectable via dip switch "A" out of 32 tones)
- ALARM, a powerful up to 105 dB electronic tone (selectable via dip switch "B" out of 32 tones).



Sirène électronique multifonctionnelle, développée avec une technologie multicanale. SIR-E S permet d'avoir deux niveaux d'alarme (pré-alarme, alarme) réglables à l'aide de connexions électriques séparées. Multi-sons : 64 sons disponibles (type industriel, civil, anti-incendie).

Tension d'utilisation

En fonction de la base de câblage utilisée.

Caractéristiques mécaniques

Polycarbonate autoextinguible, haute résistance aux chocs, adapté pour une utilisation à l'extérieur grâce au degré de protection IP65, UL TYPE 3R.

Caractéristiques acoustiques

Buzzer électromagnétique avec volume du son réglable (Min. 75 dB - Max. 105 dB) qui produit :
- PRE-ALARME, un puissant son électronique d'un maximum de 105 dB (le son peut être sélectionné à l'aide de dip-switch "A" entre 32 sons disponibles)
- ALARME, un puissant son électronique d'un maximum de 105 dB (le son peut être sélectionné à l'aide de dip-switch "B" entre 32 sons disponibles).

SIR-E MAX



SIR-E MAX

115 dB max

Cupole / Domes / Dômes

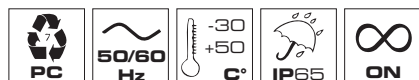

SIR-E MAX

V ACDC	12 ÷ 24	40 ÷ 80	-	-	-	-
V AC	-	-	-	120 ÷ 240	-	-
A*	1	0,5	0,3	0,12	0,08	0,05
A**	3	1	0,6	0,3	0,18	0,1
dB(A)1m	103 ÷ 115	101 ÷ 113	99	111	-	-

* Relativo al suono con assorbimento minore / It relates to the sound with lower consumption /
 Relatif au son avec une consommation minimale
 **Relativo al suono con assorbimento maggiore / It relates to the sound with higher consumption /
 Relatif au son avec une consommation maximale

Può essere installato con
 Can be installed with
 Peut être assemblé à

Basi / Bases



	SHALLOW	DEEP	WALL	
12/24V ACDC	✓	✓	✓	✓
PNP 12/24V DC	✗	✗	✓	✓
40/80V ACDC	✗	✓	✓	✓
120/240V AC	✗	✓	✓	✓
	FLUSH	DOUBLE	POLE	



Vedi sezione BASI a pag. 120
 See BASE Section on page 120
 Voir page 120, section BASES

Codici / Codes

SIR-E MAX



90407 90408 90410 90409

Sirena elettronica multifunzione, sviluppata con tecnologia multicanale. SIR-E MAX permette di gestire due diversi livelli di allarme (pre-allarme, allarme) attivabili tramite contatti elettrici indipendenti. Multisuono: 64 suoni disponibili (tipologia industriale, civile, antincendio).

Tensione operativa

A seconda della base utilizzata.

Caratteristiche meccaniche

Polycarbonato autoestinguente ad alta resistenza agli impatti, adatto per utilizzo esterno grazie al grado di protezione IP65, UL TYPE 3R.

Caratteristiche acustiche

Buzzer elettromagnetico con volume regolabile (Min. 103 dB - Max. 115 dB) che produce:
 - PRE-ALLARME, un potente suono elettronico di max. 115 dB (suono selezionabile via dip-switch "A" tra 32 suoni disponibili)
 - ALLARME, un potente suono elettronico di max. 115 dB (suono selezionabile via dip-switch "B" tra 32 suoni disponibili).

Certificazioni / Certifications



*Certificazione con utilizzo del collare di sicurezza fornito
 *Certification with the supplied safety collar
 *Certification avec le collier de sécurité fourni

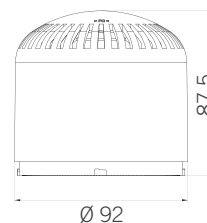

SIR-E MAX



Multifunctional electronic siren developed with a multichannel technology. SIR-E MAX allows two separate levels of alarm (pre-alarm, alarm) controllable via independent electric contacts. Multitone: 64 tones available (including industrial, civil and fire alarm tones).

Voltages

According to the installed base.

Mechanical features

Self-extinguishing PC body with high impact resistance, suitable for outdoor applications thanks to the IP65, UL TYPE 3R protection grade.

Acoustic features

Electromagnetic buzzer with adjustable volume (Min. 103 dB - Max. 115 dB) producing:
 - PRE-ALARM, a powerful up to 115 dB electronic tone (selectable via dip switch "A" out of 32 tones)
 - ALARM, a powerful up to 115 dB electronic tone (selectable via dip switch "B" out of 32 tones).



Sirène électronique multifonctionnelle, développée avec une technologie multicanale. SIR-E MAX permet d'avoir deux niveaux d'alarme (pré-alarme, alarme) réglables à l'aide de connexions électriques séparées. Multi-sons : 64 sons disponibles (type industriel, civil, anti-incendie).

Tension d'utilisation

En fonction de la base de câblage utilisée.

Caractéristiques mécaniques

Polycarbonate autoextinguible, haute résistance aux chocs, adapté pour une utilisation à l'extérieur grâce au degré de protection IP65, UL TYPE 3R.

Caractéristiques acoustiques

Buzzer électromagnétique avec volume du son réglable (Min. 103 dB - Max. 115 dB) qui produit :
 - PRE-ALARME, un puissant son électronique d'un maximum de 115 dB (le son peut être sélectionné à l'aide de dip-switch "A" entre 32 sons disponibles)
 - ALARME, un puissant son électronique d'un maximum de 115 dB (le son peut être sélectionné à l'aide de dip-switch "B" entre 32 sons disponibles).

SIR-E LED S

SIR-E LED S
allCOLORSIR-E LED S
allCLEAR

105 dB max

Cupole / Domes / Dômes

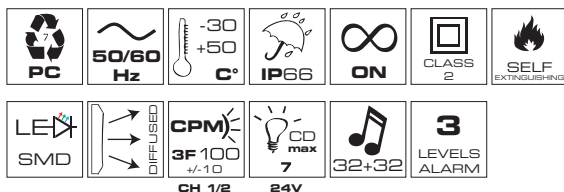

SIR-E LED S

V ACDC	12 ÷ 24	40 ÷ 80	-	-
V AC	-	-	120 ÷ 240	
mA	380 460	325 125	100	60
dB(A)1m	87 ÷ 105	90 ÷ 105	87 ÷ 105	

Può essere installato con
Can be installed with
Peut être assemblé à

Basi / Bases



	SHALLOW	DEEP	WALL	
12/24V ACDC	✓	✓	✓	✓
PNP 12/24V DC	✗	✗	✓	✓
40/80V ACDC	✗	✓	✓	✓
120/240V AC	✗	✓	✓	✓
	FLUSH	DOUBLE	POLE	

Vedi sezione BASI a pag. 120
See BASE Section on page 120
Voir page 120, section BASES

Codici / Codes

SIR-E LED S

allCOLOR
allCLEAR

90361	90362	90363	90364	90135
90131	90132	90133	90134	

Sirena elettronica con luce a LED multifunzione, sviluppata con tecnologia multicanale. SIR-E LED S permette di gestire tre diversi livelli di allarme (allerta, pre-allarme, allarme) attivabili tramite contatti elettrici indipendenti. Il prodotto è multisuono, 64 suoni disponibili (tipologia industriale, civile, antincendio) e dispone di 2 effetti luminosi (effetto strobo, luce fissa).

Tensione operativa

A seconda della base utilizzata.

Caratteristiche meccaniche

Polycarbonato autoestinguente ad alta resistenza agli impatti, adatto per utilizzo esterno grazie al grado di protezione IP65, UL TYPE 3R.

Caratteristiche acustiche e luminose

Buzzer elettromagnetico con volume regolabile (Min. 75 dB - Max. 105 dB).

6x LED disposti a 360°. Disponibile con 2 tipi di lente: allCOLOR (lente colorata con fonte luminosa colorata) e allCLEAR (lente neutra con fonte luminosa colorata), vedi pagina 103.

Tre livelli di allarme:

- ALLERTA, un potente triplo flash (effetto strobo)
- PRE-ALLARME, un potente triplo flash (effetto strobo) combinato ad un suono elettronico di max. 105 dB (suono selezionabile via dip-switch "A" tra 32 suoni disponibili)
- ALLARME, potente luce fissa combinata ad un suono elettronico di max. 105 dB (suono selezionabile via dip-switch "B" tra 32 suoni disponibili).

Certificazioni / Certifications

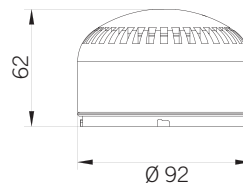

SIR-E LED S



Multifunctional LED beacon sounder developed with a multichannel technology. SIR-E LED S allows three separate levels of alarm (alert, pre-alarm, alarm) controllable via independent electric contacts.

The device is multitone, 64 tones available (including industrial, civil and fire alarm tones) and benefits from two light effects (strobe effect, steady light).

Voltages

According to the installed base.

Mechanical features

Self-extinguishing PC body with high impact resistance, suitable for outdoor applications thanks to the IP65, UL TYPE 3R protection grade.

Acoustic and Optical features

Electromagnetic buzzer with adjustable volume (Min. 75 dB - Max. 105 dB).

6 Bright LEDs over 360°. Available with 2 different lens types, allCOLOR (colored lens with colored light source) and allCLEAR (clear lens with colored light source), see page 103.

Three levels of alarm:

- ALERT, a powerful triple-flash strobe effect
- PRE-ALARM, a powerful triple-flash strobe effect combined with an up to 105 dB electronic tone (selectable via dip switch "A" out of 32 tones)
- ALARM, a powerful steady light combined with an up to 105 dB electronic tone (selectable via dip switch "B" out of 32 tones).



Dispositif acoustique/lumineux à LED multifonctionnel, développé avec une technologie multicanale. SIR-E LED S permet d'avoir trois niveaux d'alarme (alerte, pré-alarme, alarme) gérés à l'aide de connexions électriques séparées.

Le produit est multi-sons, il dispose de 64 sons (type industriel, civil, anti-incendie) et de deux effets lumineux différents (effet stroboscopique, lumière fixe).

Tension d'utilisation

En fonction de la base de câblage utilisée.

Caractéristiques mécaniques

Polycarbonate autoextinguible, haute résistance aux chocs, adapté pour une utilisation à l'extérieur grâce au degré de protection IP65, UL TYPE 3R.

Caractéristiques acoustiques et optiques

Buzzer électromagnétique avec volume du son réglable (Min. 75 dB - Max. 105 dB).

6x LED haute luminosité sur 360°. Disponible avec deux différents types de lentille : allCOLOR (lentille colorée et source lumineuse colorée) et allCLEAR (lentille incolore transparente avec source lumineuse colorée), voir page 103.

Trois niveaux d'alarme :

- ALERTE, un triple-flash puissant (effet stroboscopique)
- PRE-ALARME, un triple-flash puissant (effet stroboscopique) combiné avec un son électronique d'un maximum de 105 dB (sélectionné à l'aide de dip-switch "A" entre 32 sons disponibles)
- ALARME, une puissante lumière fixe combinée avec un son électronique d'un maximum de 105 dB (sélectionné à l'aide de dip-switch "B" entre 32 sons disponibles).

SIR-E LED MAX



SIR-E LED MAX

115 dB max

Cupole / Domes / Dômes

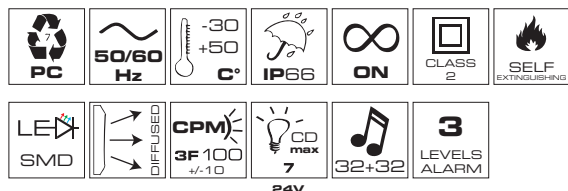

SIR-E LED MAX

V ACDC	12 ÷ 24	40 ÷ 80	-	-	-
V AC	-	-	-	120 ÷ 240	-
A*	1	0,5	0,3	0,12	0,08 0,05
A**	3	1	0,6	0,3	0,18 0,1
dB(A)1m	103 ÷ 115	101 ÷ 113	99 ÷ 111	-	-

* Relativo al suono con assorbimento minore / It relates to the sound with lower consumption /
Relatif au son avec une consommation minimale

**Relativo al suono con assorbimento maggiore / It relates to the sound with higher consumption /
Relatif au son avec une consommation maximale

Può essere installato con
Can be installed with
Peut être assemblé à

Basi / Bases



	SHALLOW	DEEP	WALL	
12/24V ACDC	✓	✓	✓	✓
PNP 12/24V DC	✗	✗	✓	✓
40/80V ACDC	✗	✓	✓	✓
120/240V AC	✗	✓	✓	✓
	FLUSH	DOUBLE	POLE	



Vedi sezione BASI a pag. 120
See BASE Section on page 120
Voir page 120, section BASES

Codici / Codes

SIR-E LED MAX



Sirena elettronica con luce a LED multifunzione ad elevate performance acustiche, sviluppata con tecnologia multicanale. SIR-E LED MAX permette di gestire tre diversi livelli di allarme (allerta, pre-allarme, allarme) attivabili tramite contatti elettrici indipendenti. Il prodotto è multisuono, 64 suoni disponibili (tipologia industriale, civile, antincendio) e dispone di 2 effetti luminosi (effetto strobo, luce fissa).

Tensione operativa

A seconda della base utilizzata.

Caratteristiche meccaniche

Polycarbonato autoestinguente ad alta resistenza agli impatti, adatto per utilizzo esterno grazie al grado di protezione IP65, UL TYPE 3R.

Caratteristiche acustiche e luminose

Buzzer elettromagnetico con volume regolabile (Min. 103 dB - Max. 115 dB).

12x LED disposti a 360°.

Tre livelli di allarme:

- ALLERTA, un potente triplo flash (effetto strobo)
- PRE-ALLARME, un potente triplo flash (effetto strobo) combinato ad un suono elettronico di max. 115 dB (suono selezionabile via dip-switch "A" tra 32 suoni disponibili)
- ALLARME, potente luce fissa combinata ad un suono elettronico di max. 115 dB (suono selezionabile via dip-switch "B" tra 32 suoni disponibili).

Certificazioni / Certifications



*Certificazione con utilizzo del collare di sicurezza fornito

*Certification with the supplied safety collar

*Certification avec le collier de sécurité fourni

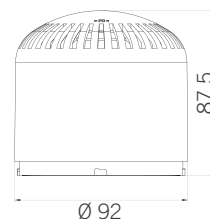

SIR-E LED MAX



Multifunctional high-output LED beacon siren developed with a multichannel technology. SIR-E LED MAX allows three separate levels of alarm (alert, pre-alarm, alarm) controllable via independent electric contacts. The device is multitone, 64 tones available (including industrial, civil and fire alarm tones) and benefits from two light effects (strobe effect, steady light).

Voltages

According to the installed base.

Mechanical features

Self-extinguishing PC body with high impact resistance, suitable for outdoor applications thanks to the IP65, UL TYPE 3R protection grade.

Acoustic and Optical features

Electromagnetic buzzer with adjustable volume (Min. 103 dB - Max. 115 dB).

12 LEDs over 360°.

Three levels of alarm:

- ALERT, a powerful triple-flash strobe effect
- PRE-ALARM, a powerful triple-flash strobe effect combined with an up to 115 dB electronic tone (selectable via dip switch "A" out of 32 tones)
- ALARM, a powerful steady light combined with an up to 115 dB electronic tone (selectable via dip switch "B" out of 32 tones).



Dispositif acoustique/lumineux à LED multifonctionnel à haute performance acoustique, développé avec une technologie multicanale. SIR-E LED MAX permet d'avoir trois niveaux d'alarme (alerte, pré-alarme, alarme) gérés à l'aide de connexions électriques séparées.

Le produit est multi-sons, il dispose de 64 sons (type industriel, civil, anti-incendie) et de deux effets lumineux différents (effet stroboscopique, lumière fixe).

Tension d'utilisation

En fonction de la base de câblage utilisée.

Caractéristiques mécaniques

Polycarbonate autoextinguible, haute résistance aux chocs, adapté pour une utilisation à l'extérieur grâce au degré de protection IP65, UL TYPE 3R.

Caractéristiques acoustiques et optiques

Buzzer électromagnétique avec volume du son réglable (Min. 103 dB - Max. 115 dB).

12x LED sur 360°.

Trois niveaux d'alarme :

- ALERTE, un triple-flash puissant (effet stroboscopique)
- PRE-ALARME, un triple-flash puissant (effet stroboscopique) combiné avec un son électronique d'un maximum de 115 dB (sélectionné à l'aide de dip-switch "A" entre 32 sons disponibles)
- ALARME, une puissante lumière fixe combinée avec un son électronique d'un maximum de 115 dB (sélectionné à l'aide de dip-switch "B" entre 32 sons disponibles).

XLF S



Cupole / Domes / Dômes

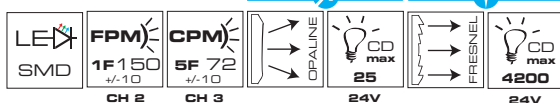

XLF S

V ACDC	12 ÷ 24	40 ÷ 80	-	-
V AC	-	-	120 ÷ 240	
mA	300	270	240	100
			80	50

Può essere installato con
Can be installed with
Peut être assemblé à

Basi / Bases



	SHALLOW		DEEP		WALL	
	FLUSH	DOUBLE	FLUSH	DOUBLE	FLUSH	DOUBLE
12/24V ACDC	✓	✓	✓	✓	✓	✓
PNP 12/24V DC	✗	✗	✓	✓	✓	✓
40/80V ACDC	✗	✓	✓	✓	✓	✓
120/240V AC	✗	✓	✓	✓	✓	✓



Vedi sezione BASI a pag. 120
See BASE Section on page 120
Voir page 120, section BASES

Codici / Codes

XLF S

	●	●	●	●	○
allCOLOR	90501	90502	90503	90504	90506
allCLEAR	90141	90142	90143	90144	
allCOLOR	90821	90822	90823	90824	90826
allCLEAR	90151	90152	90153	90154	

Dispositivo a LED multifunzione, sviluppato sulla base di una tecnologia multicanale. XLF S permette di gestire tre diversi effetti luminosi (luce fissa, lampeggiante, stroboscopica) tramite contatti elettrici indipendenti. Disponibile con lente allCOLOR e allCLEAR e in versione Proximity e Directional.

Tensione operativa

A seconda della base utilizzata.

Caratteristiche meccaniche

Polycarbonato autoestinguente ad alta resistenza agli impatti, adatto per utilizzo esterno grazie al grado di protezione IP66, UL TYPE 4X.

Caratteristiche luminose

1x LED SuperBright produce tre effetti luminosi: luce fissa, luce lampeggiante (flash singolo 1F), effetto stroboscopico 5F.

Disponibile con 2 tipi di lente: allCOLOR (lente colorata con fonte luminosa colorata) e allCLEAR (lente neutra con fonte luminosa colorata), vedi pagina 103.



Lente opaline per la segnalazione in prossimità
Opaline lens for near signalization
Lentille opaline pour signalisation à proximité



Lente di Fresnel per la segnalazione a distanza
Fresnel lens for long-distance signalization
Lentille de Fresnel pour signalisation à longue distance

Certificazioni / Certifications

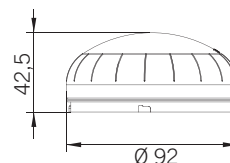

XLF S



Multifunctional LED beacon, developed with a multichannel technology. XLF S allows three different light effects (steady, flashing, strobe) controllable via independent electric contacts. Available with allCOLOR or allCLEAR lens and in Proximity or Directional version.

Voltages

According to the installed base.

Mechanical features

Self-extinguishing PC body with high impact resistance, suitable for outdoor applications thanks to the IP66, UL TYPE 4X protection grade.

Optical features

1x SuperBright LED allows three luminous effects: steady light, flashing light (single flash 1F), 5F strobe effect. Available with 2 different lens types, allCOLOR (colored lens with colored light source) and allCLEAR (clear lens with colored light source), see page 103.



Dispositif lumineux à LED multifonctionnel, développé avec une technologie multicanale. XLF S permet de gérer trois effets lumineux (lumière fixe, clignotante, stroboscopique) par connexions électriques séparées.

Disponible avec lentille allCOLOR ou allCLEAR et en version Proximity ou Directional.

Tension d'utilisation

En fonction de la base de câblage utilisée.

Caractéristiques mécaniques

Polycarbonate autoextinguible, haute résistance aux chocs, adapté pour une utilisation à l'extérieur grâce au degré de protection IP66, UL TYPE 4X.

Caractéristiques optiques

1x LED SuperBright produit trois effets lumineux: lumière fixe, clignotante (simple éclat 1F), effet stroboscopique 5F.

Disponible avec deux différents types de lentille : allCOLOR (lentille colorée et source lumineuse colorée) et allCLEAR (lentille incolore transparente avec source lumineuse colorée), voir page 103.

XLF RGB



XLF RGB

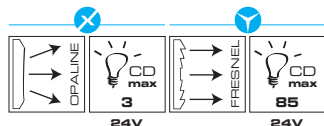
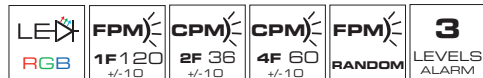

XLF RGB

V ACDC	12 ÷ 24	40 ÷ 80	-	-
V AC	-	-	120 ÷ 240	
mA	310	160	150	85
			65	35

Può essere installato con
Can be installed with
Peut être assemblé à

Basi / Bases



	SHALLOW	DEEP	WALL	
12/24V ACDC	✓	✓	✓	✓
PNP 12/24V DC	✗	✗	✓	✓
40/80V ACDC	✗	✓	✓	✓
120/240V AC	✗	✓	✓	✓
	FLUSH	DOUBLE	POLE	



Vedi sezione BASI a pag. 120
See BASE Section on page 120
Voir page 120, section BASES

Codici / Codes

XLF RGB

✕	90155
Ⓜ	90156

Dispositivo a LED multicolore, sviluppato sulla base di una tecnologia multicanale. XLF RGB permette di gestire tre diversi livelli di allarme, tramite contatti elettrici indipendenti. Per ogni canale è possibile selezionare tra otto diversi colori e cinque effetti luminosi. Disponibile in versione Proximity e Directional.

Tensione operativa

A seconda della base utilizzata.

Caratteristiche meccaniche

Polycarbonato autoestinguente ad alta resistenza agli impatti, adatto per utilizzo esterno grazie al grado di protezione IP66.

Caratteristiche luminose

6x LED RGB multicolore ad alta luminosità. 3 canali disponibili. Per ogni canale è possibile selezionare il colore desiderato (bianco, ambra, giallo, rosso, ciano, verde, magenta e blu) e l'effetto luminoso (luce fissa, lampeggio singolo 1F, doppio lampeggio 2F, lampeggio quadruplo 4F, effetto random) tramite i due pulsanti sul circuito.



Lente opaline per la segnalazione in prossimità
Opaline lens for near signalization
Lentille opaline pour signalisation à proximité



Lente di Fresnel per la segnalazione a distanza
Fresnel lens for long-distance signalization
Lentille de Fresnel pour signalisation à longue distance

Certificazioni / Certifications

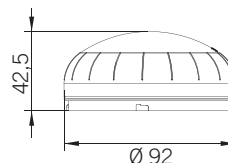

Multicolor LED beacon, developed with a multichannel technology. XLF RGB allows three separate levels of alarm, controllable via independent electric contacts. For each channel eight different colors and five light effects can be selected. Available with Proximity and Directional lenses.



Dispositif lumineux à LED multicolore, développé avec une technologie multicanale. XLF RGB permet d'avoir trois niveaux d'alarme gérés par connexions électriques séparées. Pour chaque canal, on peut sélectionner une des huit couleurs différentes et un des cinq effets lumineux. Disponible avec lentille Proximity ou Directional.

Voltages

According to the installed base.

Mechanical features

Self-extinguishing PC body with high impact resistance, suitable for outdoor applications thanks to the IP66.

Optical features

6x SuperBright Multicolor RGB LEDs. 3 levels of alarm. Each channel allows the selection of a color (white, amber, yellow, red, cyan, green, magenta, blue) and light effect required (steady light, single flash 1F, double flash 2F, 4x strobe effect, random effect) via the two switches on the circuit.

Tension d'utilisation

En fonction de la base de câblage utilisée.

Caractéristiques mécaniques

Polycarbonate autoextinguible, haute résistance aux chocs, adapté pour une utilisation à l'extérieur grâce au degré de protection IP66.

Caractéristiques optiques

6x LED SuperBright RGB multicolore. 3 canaux disponibles. Pour chaque canal, on peut sélectionner la couleur souhaitée (blanc, orange, rouge, jaune, cyan, vert, magenta et bleu) et régler l'effet lumineux (lumière fixe, simple éclat 1F, double éclat 2F, quadruple éclat 4F, effet random) en utilisant les deux boutons poussoirs sur le circuit.

XLF RGA



XLF RGA

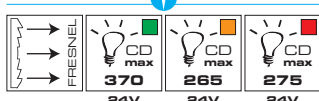
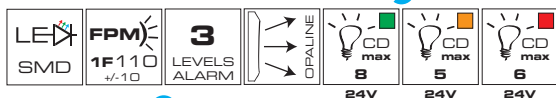

XLF RGA

V ACDC	12 ÷ 24	40 ÷ 80	-	-
V AC	-	-	120 ÷ 240	
mA	190	190	120	65
			40	25

Può essere installato con
Can be installed with
Peut être assemblé à

Basi / Bases



	SHALLOW		DEEP		WALL	
	FLUSH	DOUBLE	FLUSH	DOUBLE	FLUSH	DOUBLE
12/24V ACDC	✓	✓	✓	✓	✓	✓
PNP 12/24V DC	✗	✗	✓	✓	✓	✓
40/80V ACDC	✗	✓	✓	✓	✓	✓
120/240V AC	✗	✓	✓	✓	✓	✓

Vedi sezione BASI a pag. 120
See BASE Section on page 120
Voir page 120, section BASES

Codici / Codes

XLF RGA

- 90507
- 90847

Dispositivo a LED multicolore, sviluppato sulla base di una tecnologia multicanale. XLF RGA permette di gestire tre diversi colori, tramite contatti elettrici indipendenti. Disponibile in versione Proximity e Directional.

Tensione operativa

A seconda della base utilizzata.

Caratteristiche meccaniche

Polycarbonato autoestinguente ad alta resistenza agli impatti, adatto per utilizzo esterno grazie al grado di protezione IP66, TYPE 4X.

Caratteristiche luminose

1x LED Superbright multicolore.
3 canali disponibili (luce rossa, verde, ambr). Per ogni canale è possibile selezionare l'effetto luminoso (luce fissa o lampeggiante 1F) tramite dip-switch.



Lente opaline per la segnalazione in prossimità
Opaline lens for near signalization
Lentille opaline pour signalisation à proximité



Lente di Fresnel per la segnalazione a distanza
Fresnel lens for long-distance signalization
Lentille de Fresnel pour signalisation à longue distance

Certificazioni / Certifications

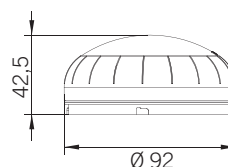

XLF RGA



Multicolor LED beacon, developed with a multichannel technology. XLF RGA allows three different colors, controllable via independent electric contacts. Available with Proximity and Directional lenses.

Voltages

According to the installed base.

Mechanical features

Self-extinguishing PC body with high impact resistance, suitable for outdoor applications thanks to the IP66, TYPE 4X.

Optical features

1x SuperBright Multicolor LED.
3 separate functions (red, green, amber). Each channel allows the selection of the light effect (steady or 1F flashing light) via dip-switch.



Dispositif lumineux à LED multicolore, développé avec une technologie multicanale. XLF RGA permet de gérer trois couleurs différentes par connexions électriques séparées. Disponible avec lentille Proximity ou Directional.

Tension d'utilisation

En fonction de la base de câblage utilisée.

Caractéristiques mécaniques

Polycarbonate autoextinguible, haute résistance aux chocs, adapté pour une utilisation à l'extérieur grâce au degré de protection IP66, TYPE 4X.

Caractéristiques optiques

1x LED SuperBright multicolore.
3 canaux disponibles (lumière rouge, verte, orange). Pour chaque canal, on peut régler l'effet lumineux (lumière fixe ou clignotante 1F) par dip-switch.



GAMMA FA

LUCI E SIRENE OMOLOGATE EN54

Quando la sicurezza è una priorità, assicurarsi che i dispositivi di segnalazione più appropriati vengano utilizzati, diventa un lavoro di responsabilità. La gamma **MLINE** FA (Fire Alarm) è stata sviluppata per fare proprio questo: fornire agli utenti finali dispositivi di segnalazione di alta qualità e approvati EN54. La nostra gamma di dispositivi acustici (SIR-E FA), luminosi (SLR FA, XLF FA) e acustico/luminosi (SIR-E LED FA) ha ottenuto l'omologazione EN54-3/EN54-23. I suoni certificati sono stati selezionati per soddisfare i clienti più esigenti. I dispositivi certificati sono stati progettati con una tipologia di lampeggio adatta alle applicazioni di allarme antincendio concepiti per migliorare la visibilità anche nelle condizioni più critiche.

La normativa EN54 sul rilevamento incendio e sistemi di allarme antincendio, è lo standard che specifica i requisiti dei dispositivi e i test di laboratorio da eseguire per ogni componente per il **rilevamento incendio e sistemi di allarme antincendio** e permette la libera circolazione dei dispositivi tra i paesi del mercato dell'**Unione Europea**.

La normativa è stata sviluppata e approvata dal **Comitato Europeo per la standardizzazione**.

Questa normativa è ampiamente riconosciuta in tutto il mondo e in molti paesi al di fuori dell'**Unione Europea**. È riconosciuta anche nei paesi latino-americani, come in Brasile, nei paesi africani e asiatici e diverse isole dell'Oceano Pacifico.



FA RANGE

EN54 APPROVED FIRE ALARM BEACONS AND SOUNDERS

When safety is a priority, making sure the most appropriate signaling devices are used, becomes a job of responsibility. The **MLINE** FA (Fire Alarm) range has been developed to do just this: deliver end-users with high-quality EN54 approved signaling devices. Our range of sounders (SIR-E FA), beacons (SLR FA, XLF FA) and beacon/sounders (SIR-E LED FA) have been granted EN54-3/EN54-23 approval. The certified tones have been selected to satisfy the most demanding customers. The certified beacons have been engineered with a flashing pattern optimized for fire alarm applications enhancing visibility even under the most critical conditions.

The EN54 fire detection and fire alarm systems is a mandatory standard that specifies requirements and laboratory test for every component of **fire detection and fire alarm system** and it allows the free movement of construction products between countries of the **European Union** market.

It was developed and approved by **European Committee for Standardization**.

This standard is widely recognized around the world for several countries outside of **European Union**. It is recognized in Latin American countries, Brasil, African and Asian countries and several islands in the Pacific Ocean.



GAMME FA

DISPOSITIFS LUMINEUX ET SIRENES CERTIFIES SELON EN54

Quand la sécurité est une priorité, il faut s'assurer que les dispositifs de signalisation soient les plus adaptés, là commence notre responsabilité !



La gamme **MLINE** FA (Alarme Incendie) offre aux utilisateurs finaux des dispositifs de signalisation certifiés selon la norme EN54.

Notre gamme de sirènes (SIR-E FA) et dispositifs lumineux et/ou acoustique (SLR FA, XLF FA, SIR-E LED FA) répond aux normes EN54-3/EN54-23. Les tonalités ont été choisies de façon à satisfaire les demandes de nos clients. Les effets lumineux de nos dispositifs sont optimisés pour les **systèmes d'alarmes incendies**, permettant une visibilité même dans les situations les plus critiques.

La conformité de nos produits aux normes de l'EN54 fait d'eux des dispositifs pouvant être installés partout dans l'**Union Européenne**. Cette norme a été mise en place par le **Comité Européen de Normalisation**. Elle est aussi reconnue dans le reste du monde comme en Amérique latine, en Afrique, en Asie et dans certaines îles de l'Océan Pacifique.



Secondo il Regolamento CPR (Construction Products Regulation) 305/2011/UE, è obbligatorio che i sistemi di Rilevamento Incendi e di Allarme Antincendio abbiano la certificazione EN54 rilasciata da un Ente notificato per la Certificazione.

-  According to the Construction Products Regulation (CPR) 305/2011/EU, it is mandatory that Fire Detection and Fire Alarm equipments are certified under EN54 Standard by a notified Certification Body.
-  Selon le Construction Products Regulation (CPR) 305/2011/UE, il est obligatoire que les systèmes de Détection Incendie soient reconnus comme conformes à la norme EN54 par un Organisme notifié à le faire.



SIR-E FA



SIR-E FA

100 dB max - EN54-3

Cupole / Domes / Dômes

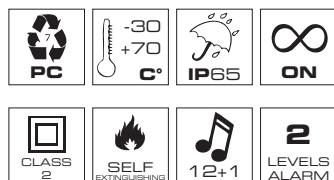

SIR-E FA

V DC	12 ÷ 24
mA	45 35
dB(A)1m	80 ÷ 100

Può essere installato con
Can be installed with
Peut être assemblé à

Basi / Bases



	SHALLOW		DEEP		WALL	
12/24V ACDC	✓	✓	✓	✓	✓	✓
PNP 12/24V DC	✗	✗	✓	✓	✓	✓
	FLUSH		DOUBLE		POLE	

Vedi sezione BASI a pag. 120
See BASE Section on page 120
Voir page 120, section BASES

Codici / Codes

SIR-E FA

90378 90377

Sirena elettronica multifunzione certificata EN54-3. Sviluppata con tecnologia multicanale, SIR-E FA permette di gestire due diversi livelli di allarme (pre-allarme, allarme) attivabili tramite contatti elettrici indipendenti. Multisuono: 13 suoni certificati EN54-3.

Tensione operativa

Utilizzo consentito solo con basi LT 12/24V.

Caratteristiche meccaniche

Polycarbonato autoestinguente ad alta resistenza agli impatti, adatto per utilizzo esterno grazie al grado di protezione IP65.

Caratteristiche acustiche

Buzzer elettromagnetico che produce:

- PRE-ALLARME, un potente suono elettronico di max. 100 dB (suono selezionabile via dip-switch tra 12 suoni certificati EN54-3)
- ALLARME, un potente suono elettronico di max. 100 dB (1 suono continuo certificato EN54-3: PFEER TOXIC GAS).

Certificazioni / Certifications



Numero CPR / Construction products regulation / Numero d'homologation CPR
EN54-3 | 1328-CPR-0479

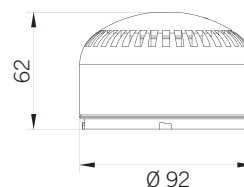

SIR-E FA



EN54-3 approved multifunctional electronic sounder. Developed with a multichannel technology, SIR-E FA allows two separate levels of alarm (pre-alarm, alarm) controllable via independent electric contacts.
Multitone: 13 EN54-3 approved tones.

Voltages

Must be used with LT 12/24V base.

Mechanical features

Self-extinguishing PC body with high impact resistance, suitable for outdoor applications thanks to the IP65 protection grade.

Acoustic features

Electromagnetic buzzer producing:
- PRE-ALARM, a powerful up to 100 dB electronic tone (selectable via dip switch out of 12 EN54-3 approved tones)
- ALARM, a powerful up to 100 dB electronic tone (1 EN54-3 approved continuous tone: PFEER TOXIC GAS).



Sirène électronique multifonctionnelle certifiée selon la norme EN54-3. Développée avec une technologie multicanale, SIR-E FA permet d'avoir deux niveaux d'alarme (pré-alarme, alarme) réglables à l'aide de connexions électriques séparées. Multi-sons : 13 sons homologués selon EN54-3.

Tension d'utilisation

Utilisation autorisée seulement avec bases LT 12/24V.

Caractéristiques mécaniques

Polycarbonate autoextinguible, haute résistance aux chocs, adapté pour une utilisation à l'extérieur grâce au degré de protection IP65.

Caractéristiques acoustiques

Buzzer électromagnétique qui produit :
- PRE-ALARME, un puissant son électronique d'un maximum de 100 dB (le son peut être sélectionné à l'aide de dip-switch entre 12 sons homologués selon EN54-3)
- ALARME, un puissant son électronique d'un maximum de 100 dB (un son continu homologué selon EN54-3 : type PFEER TOXIC GAS).

SIR-E LED FA



SIR-E LED FA

100 dB max - EN54-3

Cupole / Domes / Dômes

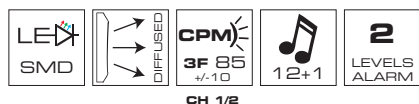

SIR-E LED FA

V DC	12 ÷ 24
mA	120 110
dB(A)1m	80 ÷ 100

Può essere installato con
Can be installed with
Peut être assemblé à

Basi / Bases



	EN54-3	EN54-3	EN54-3
	SHALLOW	DEEP	WALL
12/24V ACDC	✓	✓	✓
PNP 12/24V DC	✗	✗	✓
	FLUSH	DOUBLE	POLE

Vedi sezione BASI a pag. 120
See BASE Section on page 120
Voir page 120, section BASES

Codici / Codes

SIR-E LED FA

90380 90379

Sirena elettronica con luce a LED multifunzione certificata EN54-3. Sviluppata con tecnologia multicanale, SIR-E LED FA permette di gestire due diversi livelli di allarme (pre-allarme, allarme) attivabili tramite contatti elettrici indipendenti. Multisuono: 13 suoni certificati EN54-3 e luce con effetto stroboscopico.

Tensione operativa

Utilizzo consentito solo con basi LT 12/24V.

Caratteristiche meccaniche

Polycarbonato autoestinguente ad alta resistenza agli impatti, adatto per utilizzo esterno grazie al grado di protezione IP65.

Caratteristiche acustiche e luminose

Buzzer elettromagnetico. 4 LED Bright disposti a 360°.

Due livelli di allarme:

- PRE-ALLARME, un potente triplo flash (effetto strobo) combinato ad un potente suono elettronico di max. 100 dB (suono selezionabile via dip-switch tra 12 suoni certificati EN54-3)
- ALLARME, un potente triplo flash (effetto strobo) combinato ad un potente suono elettronico di max. 100 dB (1 suono continuo certificato EN54-3: PFEER TOXIC GAS).

Certificazioni / Certifications



Numero CPR / Construction products regulation / Numero d'homologation CPR
EN54-3 | 1328-CPR-0479

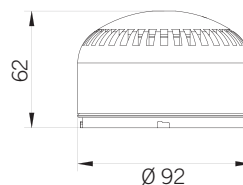

SIR-E LED FA



EN54-3 approved multifunctional electronic LED beacon sounder. Developed with a multichannel technology, SIR-E LED FA allows two separate levels of alarm (pre-alarm, alarm) controllable via independent electric contacts. The device is multitone, 13 EN54-3 approved tones enriched by a strobe effect flashing light.

Voltages

Must be used with LT 12/24V base.

Mechanical features

Self-extinguishing PC body with high impact resistance, suitable for outdoor applications thanks to the IP65 protection grade.

Acoustic and optical features

Electromagnetic buzzer. 4 Bright LEDs over 360°.

Two levels of alarm:

- PRE-ALARM, a powerful up to 100 dB electronic tone (selectable via dip switch out of 12 EN54-3 approved tones) sustained by a strobe effect flashing light
- ALARM, a powerful up to 100 dB electronic tone (1 EN54-3 approved continuous tone: PFEER TOXIC GAS) sustained by a strobe effect flashing light.



Dispositif acoustique/lumineux à LED multifonctionnel certifié selon la norme EN54-3. Développé avec une technologie multicanale, SIR-E LED FA permet d'avoir deux niveaux d'alarme (pré-alarme, alarme) réglables à l'aide de connexions électriques séparées. Le produit est multi-sons, il dispose de 13 sons homologués selon EN54-3 et se complète avec une lumière à effet stroboscopique.

Tension d'utilisation

Utilisation autorisée seulement avec bases LT 12/24V.

Caractéristiques mécaniques

Polycarbonate autoextinguible, haute résistance aux chocs, adapté pour une utilisation à l'extérieur grâce au degré de protection IP65.

Caractéristiques acoustiques et optiques

Buzzer électromagnétique. 4 LED haute luminosité sur 360°.

Deux niveaux d'alarme :

- PRE-ALARME, un triple-flash puissant (effet stroboscopique) combiné avec un puissant son électronique d'un maximum de 100 dB (le son peut être sélectionné à l'aide de dip-switch entre 12 sons homologués selon EN54-3)
- ALARME, un triple-flash puissant (effet stroboscopique) combiné avec un puissant son électronique d'un maximum de 100 dB (un son continu homologué selon EN54-3 : type PFEER TOXIC GAS).

SLR FA



SLR FA

EN54-23*

*Certificazione EN54-23 per il solo modello con luce bianca

*EN54-23 approval white color version only

*Homologation EN54-23 seulement pour la version avec lumière blanche (codice / part no. / code 90125)

Cupole / Domes / Dômes



SLR FA

V DC	24
mA	300

Può essere installato con
Can be installed with
Peut être assemblé à

Basi / Bases



EN54-23

Vedi sezione BASI a pag. 120
See BASE Section on page 120
Voir page 120, section BASES

Codici / Codes

SLR FA



Dispositivo a LED certificato EN54-23* (24V DC) ad alte performance ottiche. SLR FA dispone di un effetto luminoso monolampo.

Tensione operativa

Utilizzo consentito solo con basi LT 12/24V.

Caratteristiche meccaniche

Polycarbonato autoestinguente ad alta resistenza agli impatti, adatto per utilizzo esterno grazie al grado di protezione IP66.

Caratteristiche luminose

2x LED SuperBright ad alta luminosità, con lenti di Fresnel interna, producono luce lampeggiante (flash singolo 1F).

Certificazioni / Certifications



Numero CPR / Construction products regulation / Numero d'homologation CPR
EN54-23 | 1328-CPR-0423

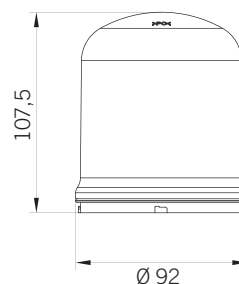

SLR FA



EN54-23* approved LED beacon (24V DC) with excellent optical performance. SLR FA allows a flashing effect (single flash).

Voltages

Must be used with LT 12/24V base.

Mechanical features

Self-extinguishing PC body with high impact resistance, suitable for outdoor applications thanks to the IP66 protection grade.

Optical features

2x SuperBright LEDs, with inner Fresnel lens, allow a flashing light (single flash 1F).



Dispositif à LED certifié selon la norme EN54-23* (24V DC) à haute performance optique. SLR FA dispose d'un effet lumineux simple éclat.

Tension d'utilisation

Utilisation autorisée seulement avec bases LT 12/24V.

Caractéristiques mécaniques

Polycarbonate autoextinguible, haute résistance aux chocs, adapté pour une utilisation à l'extérieur grâce au degré de protection IP66.

Caractéristiques optiques

2x LED SuperBright avec lentille de Fresnel à l'intérieur, produisent une lumière clignotante (simple éclat 1F).

XLF FA



XLF FA

EN54-23*

*Certificazione EN54-23 per il solo modello con luce bianca

*EN54-23 approval white color version only

*Homologation EN54-23 seulement pour la version avec lumière blanche (codice / part no. / code 90127)

Cupole / Domes / Dômes



XLF FA

V DC	24
mA	150

Può essere installato con
Can be installed with
Peut être assemblé à

Basi / Bases



	EN54-23	EN54-23	
	SHALLOW	DEEP	WALL
12/24V ACDC	✓	✓	✓
PNP 12/24V DC	✗	✗	✓
	FLUSH	DOUBLE	POLE

Vedi sezione BASI a pag. 120
See BASE Section on page 120
Voir page 120, section BASES

Codici / Codes

XLF FA



Dispositivo a LED certificato EN54-23* (24V DC) ad alte performance ottiche. XLF FA dispone di un effetto luminoso monolampo. Disponibile con lente Directional.

Tensione operativa

Utilizzo consentito solo con basi LT 12/24V.

Caratteristiche meccaniche

Polycarbonato autoestinguente ad alta resistenza agli impatti, adatto per utilizzo esterno grazie al grado di protezione IP66.

Caratteristiche luminose

1x LED SuperBright ad alta luminosità, luce lampeggiante (flash singolo 1F).



Lente di Fresnel per la segnalazione a distanza
Fresnel lens for long-distance signalization
Lentille de Fresnel pour signalisation à longue distance

Certificazioni / Certifications



Numero CPR / Construction products regulation / Numero d'homologation CPR
EN54-23 | 1328-CPR-0421

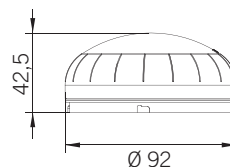

XLF FA



EN54-23* approved LED beacon (24V DC) with excellent optical performance. XLF FA allows a flashing effect (single flash). Available with Directional lens.

Voltages

Must be used with LT 12/24V base.

Mechanical features

Self-extinguishing PC body with high impact resistance, suitable for outdoor applications thanks to the IP66 protection grade.

Optical features

1x SuperBright LED allows a flashing light (single flash 1F).



Dispositif à LED certifié selon la norme EN54-23* (24V DC) à haute performance optique. XLF FA dispose d'un effet lumineux simple éclat. Disponible avec lentille Directional.

Tension d'utilisation

Utilisation autorisée seulement avec bases LT 12/24V.

Caractéristiques mécaniques

Polycarbonate autoextinguible, haute résistance aux chocs, adapté pour une utilisation à l'extérieur grâce au degré de protection IP66.

Caractéristiques optiques

1x LED SuperBright haute luminosité produit une lumière clignotante (simple éclat 1F).

BASI / BASES



SHALLOW

Codici / Codes

SHALLOW

LT 12/24V ACDC 90367 90451 90343 90344



SHALLOW

Base bassa ideale per il montaggio superficiale dove il cablaggio avviene dalla base del dispositivo e dove è richiesta una maggiore compattezza dello stesso.



Base designed for flat surface mounting where cabling occurs from the bottom of the device and where a compact design is required.



Base basse idéale pour le montage à plat avec câblage par le dessous de la base et offrant un dispositif d'un très faible encombrement.

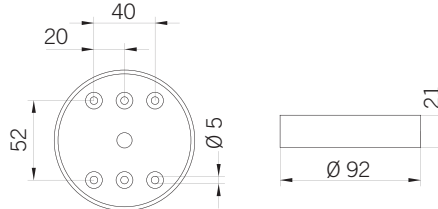

DEEP

Base progettata per il montaggio superficiale ad ingresso laterale attraverso uno o due pressacavi M20. Questa è la soluzione ideale quando il cablaggio dalla base del dispositivo non è effettuabile o quando è richiesta un'installazione in serie. Disponibile anche con collegamenti PNP (positivo-negativo-positivo) per uso con PLC in modalità sourcing.



Base designed for flat surface mounting in conjunction with the use of cable glands. This base allows up to two M20 cable glands making this solution ideal for series mounting. Also available with PNP (positive-negative-positive) connections for use with PLC in sourcing mode.



Base idéale pour le montage à plat avec entrée de câblage latérale par un ou deux presse-étoupes M20. C'est la solution idéale quand le câblage par le dessous de la base du dispositif n'est pas possible ou quand une installation en série est nécessaire. Disponible aussi avec connexions PNP (positif-négatif-positif) pour utilisation avec PLC en mode "sourcing".

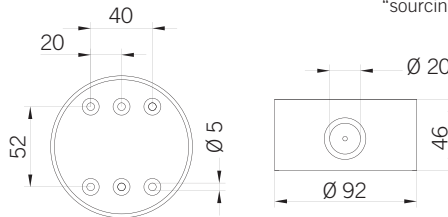

2 x M20 (forniti / supplied / fournis)

Codici / Codes

DEEP

LT 12/24V ACDC 90368 90452 90345 90346
 LT PNP 12/24V DC 90570 90573 90579 90576
 MT 40/80V ACDC 90432 90455 90442 90437
 HT 120/240V AC 90369 90458 90508 90509



WALL

Codici / Codes

WALL

LT 12/24V ACDC 90370 90453 90347 90348
 LT PNP 12/24V DC 90571 90574 90577 90580
 MT 40/80V ACDC 90433 90456 90443 90438
 HT 120/240V AC 90371 90459 90510 90511

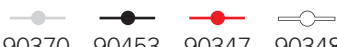

WALL

Base per montaggio a parete, è la scelta ideale per installazioni laterali. Offre la possibilità di utilizzare fino a due pressacavi M20 offrendo la possibilità di installare il prodotto sia in serie che in punti non cablabili dal retro del prodotto. Disponibile anche con collegamenti PNP (positivo-negativo-positivo) per uso con PLC in modalità sourcing.



Base designed for lateral/wall mounting. Allows installing up to two M20 pressure glands making this product suitable also when it's not possible to wire the base of the signaling device. Also available with PNP (positive-negative-positive) connections for use with PLC in sourcing mode.



Base pour montage en applique. C'est le choix idéal pour des installations en parois. Elle offre la possibilité d'utiliser jusqu'à deux presse-étoupes M20, permettant de câbler le produit en série, avec entrée de câbles par le dessous de la base mais avec aussi deux entrées de câbles par l'arrière de la face d'appui. Disponible avec connexions PNP (positif-négatif-positif) pour utilisation avec PLC en mode "sourcing".

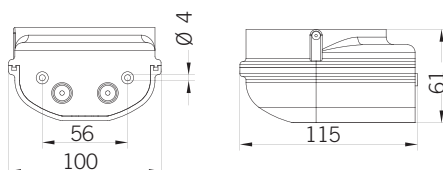

2 x M20 (predisposta / ready / prédisposée)



BASI / BASES



Codici / Codes

DOUBLE

	LT	MT	HT
LT 12/24V ACDC	90372	90454	90373
LT PNP 12/24V DC	90572	90575	90578
MT 40/80V ACDC	90435	90457	90445
HT 120/240V AC	90512	90460	90513

DOUBLE



DOUBLE

Base a parete ideale per installare fino a due dispositivi della gamma **MLINE**. Ideale per creare combinazioni uniche tra moduli luminosi e moduli acustici garantendo la multifunzionalità degli stessi. Disponibile anche con collegamenti PNP (positivo-negativo-positivo) per uso con PLC in modalità sourcing.



Base designed for lateral/wall mounting, it can mount up to two **MLINE** modules creating unique combinations between visual and acoustic devices whilst the multifunctionality of each module is guaranteed. Also available with PNP (positive-negative-positive) connections for use with PLC in sourcing mode.



Base pour montage en applique. Elle est l'idéale pour installer jusqu'à deux dispositifs de la gamme **MLINE**. Parfaite pour créer des combinaisons uniques de modules acoustiques et lumineux, assurant ainsi la multifonctionnalité de ceux-ci. Disponible aussi avec connexions PNP (positif-négatif-positif) pour utilisation avec PLC en mode "sourcing".

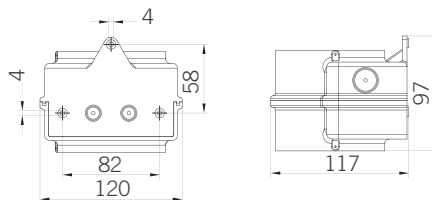

2 x M20 (predisposta / ready / prédisposée)



Codici / Codes

FLUSH

	LT	MT	HT
LT 12/24V ACDC	90349	90375	
MT 40/80V ACDC	90444	90439	
HT 120/240V AC	90446	90376	

FLUSH

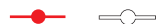

Usa interno
Indoor use
Usage en intérieur

FLUSH

Base ad incasso ideale per il montaggio in controsoffittature. Garantisce una semplice e discreta installazione del dispositivo adatta a tutte quelle situazioni in cui è necessario rispettare standard estetici, come ad esempio in applicazioni civili e commerciali.

Non certificata UL.



Base designed for flushmounted applications. It guarantees a simple and discrete installation of the device allowing a low visual impact when aesthetic is required like for example in Civil or Commercial installations.

Not UL approved.



Base à encastrer idéale pour le montage en faux-plafond. Elle assure une installation simple et discrète du dispositif adaptée à toutes les situations où il est nécessaire de respecter des normes esthétiques, comme par exemple dans des applications grand public et commerciales.

Non certifiée UL.

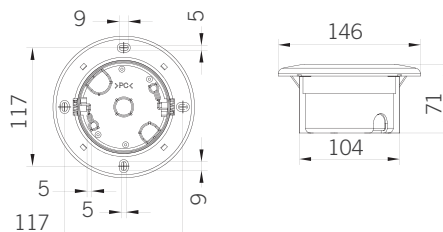

Codici / Codes

POLE

	LT	MT	HT
LT 12/24V ACDC	90610	90613	90619
LT PNP 12/24V DC	90622	90624	90628
MT 40/80V ACDC	90611	90614	90620
HT 120/240V AC	90612	90615	90621

POLE

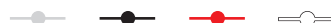

POLE

Consente l'installazione di qualsiasi cupola **MLINE** su un palo filettato da 1" ½ NPT o, tramite adattatori, su un palo filettato da 1" o ½" NPT.

Disponibile anche con collegamenti PNP (positivo-negativo-positivo) per uso con PLC in modalità sourcing. Certificazione UL con utilizzo del collare di sicurezza fornito.



Base designed for pole mounted installations. It allows to install any **MLINE** dome on a 1" ½ NPT threaded pole or, via the use of adaptors, on a 1" or ½" NPT threaded pole. Also available with PNP (positive-negative-positive) connections for use with PLC in sourcing mode. UL certification with supplied safety collar.



Conçue pour installer n'importe quel dôme **MLINE** sur mât fileté de 1"½ NPT ou, par adaptateurs, sur mât fileté de 1" ou ½" NPT. Disponible avec connexions PNP (positif-négatif-positif) pour utilisation avec PLC en mode "sourcing". Certification UL avec le collier de sécurité fourni.

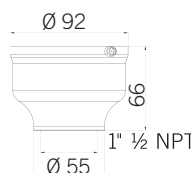

1" NPT-F ADATTATORE / ADAPTER / ADAPTATEUR 90555
½" NPT-F ADATTATORE / ADAPTER / ADAPTATEUR 90556



ACCESSORI / ACCESSORIES
ACCESSOIRES



SIZE 0
90557



SIZE 1
90551



SIZE 2
90552



SIZE 3
90553



SIZE 4
90554

GRIGLIE DI PROTEZIONE IN ACCIAIO INOX (USO GRAVOSO)
STAINLESS STEEL PROTECTION GRIDS (HEAVY DUTY)
GRILLES DE PROTECTION EN ACIER INOX (USAGE LOURD)

SIZE / TAILLE 0

BASE SHALLOW
+ XLF S, RGA, RGB

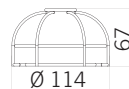
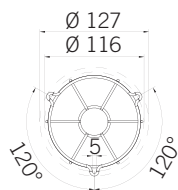

SIZE 0



SIZE / TAILLE 1

BASE SHALLOW
+ SIR-E S
+ SIR-E LED S

BASE DEEP
+ XLF S, RGA, RGB

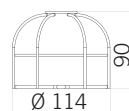
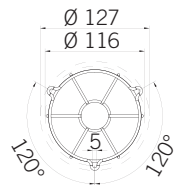

SIZE 1



SIZE / TAILLE 2

BASE DEEP
+ SIR-E S
+ SIR-E LED S

BASE SHALLOW
+ SIR-E MAX
+ SIR-E LED MAX

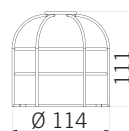
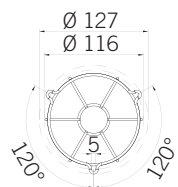

SIZE 2



SIZE / TAILLE 3

BASE SHALLOW
+ FLR S
+ SLR S

BASE DEEP
+ SIR-E MAX
+ SIR-E LED MAX

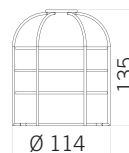
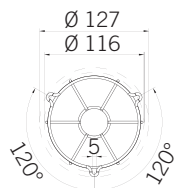

SIZE 3



SIZE / TAILLE 4

BASE DEEP
+ FLR S
+ SLR S

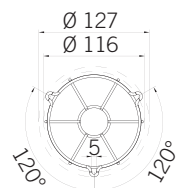

SIZE 4



100% di compatibilità con la gamma MLINE
100% compatibility with MLINE range
Compatibilité 100% avec la gamme MLINE

5 formati per contemplare tutti gli scenari
5 sizes to fit each applications
5 dimensions adaptables à toutes les formes

Acciaio INOX
Stainless Steel
Acier INOX





CERTIFICAZIONI CERTIFICATIONS CERTIFICATIONS

La gamma **MLINE** è certificata secondo le norme CE (EN60598-1, EN61000-6-3, EN61000-6-2).

The **MLINE** range is certified according to CE (EN60598-1, EN61000-6-3, EN61000-6-2) standards.

La gamme **MLINE** est conforme aux normes CE (EN60598-1, EN61000-6-3, EN61000-6-2).



La gamma **MLINE** ha ottenuto la certificazione EAC (che ha sostituito la certificazione GOST) con validità estesa ai tre paesi componenti l'Unione Doganale Eurasiatica: Russia, Bielorussia e Kazakistan, con previsioni a breve termine di estensione ad Armenia, Tagikistan e Kirghizistan.

The **MLINE** range also achieved EAC certification (replacing GOST certification) whose validity is extended to the three member countries of the Eurasian Customs Union: Russia, Belarus and Kazakhstan. Shortly to be extended to Armenia, Tajikistan and Kyrgyzstan.

La gamme **MLINE** a également obtenu la certification EAC (qui remplace la marque GOST) avec validité étendue aux trois pays de l'Union Douanière Eurasienne : Russie, Biélorussie et le Kazakhstan (prévision d'extension à court terme à l'Arménie, le Tadjikistan et le Kirghizistan).



MLINE ha ottenuto la certificazione UL per gli Stati Uniti e il Canada con grado di protezione TYPE 4X per i dispositivi luminosi e TYPE 3R per i dispositivi acustici e acustico/luminosi, il più alto nella sua categoria.

MLINE has achieved UL certification for the U.S. and Canada with protection grade TYPE 4X for beacons and TYPE 3R for sounders and beacon/sounders, the highest in its category.

MLINE a obtenu la certification UL pour les Etats-Unis et le Canada, degré de protection TYPE 4X, pour les dispositifs lumineux, et TYPE 3R pour les dispositifs acoustiques et acoustiques/lumineux le plus élevé de sa catégorie.



La gamma **MLINE** FA è conforme alle disposizioni contenute nella direttiva EN54.

MLINE FA range is approved according to regulations stated in the EN54 directive.

La gamma **MLINE** FA est conforme aux prescriptions prévues par la directive EN54.





AUTOMAX

Dispositivi per l'automazione industriale
Devices for the automation industry
Dispositifs pour l'industrie de l'automatisme



SIRENA



INDICE / INDEX / INDEX

128 Segnalazione per l'automazione
Signaling for the automation industry
Signalisation pour l'industrie de l'automatisme

130 Direttiva macchine
Machine directive
Directive machines

132 all**COLOR** | all**CLEAR** | PRO**X**IMITY

134 Gamma Elyps
Elyps range
Gamme Elyps

136 3 filosofie di configurazione / 3 configuration philosophies / 3 philosophies de configuration
138 ELYPS WM
139 ELYPS LM
140 ELYPS LM S
141 ELYPS LM S MULTI
142 ELYPS LM X MULTI
143 ELYPS AM
144 ELYPS MB



146 Gamma TWS
TWS range
Gamme TWS

149 Montaggio moduli / Mounting combinations / Combinaisons de montage
150 TWS BASE
151 TWS LED
152 TWS S
153 TWS RGA
154 TWS STEADY/FLASHING
155 TWS X
156 TWS ACUSTICHE / TWS SOUNDERS / TWS ACOUSTIQUES
157 TWS HD
158 Codici TWS / TWS part numbers / Codes TWS
161 miniTWS
163 babyTWS
164 Codici miniTWS - babyTWS / miniTWS - babyTWS part numbers / Codes miniTWS - babyTWS
164 Lampade ricambio / Spare bulbs / Ampoules de rechange
165 Accessori / Accessories / Accessoires



166 Gamma LUXOR
LUXOR range
Gamme LUXOR

167 LUXOR LED
168 Accessori / Accessories / Accessoires



169 Certificazioni
Certifications
Certifications

SEGNALAZIONE PER L'AUTOMAZIONE

Da sempre la linea **AUTOMAX** rappresenta un punto di riferimento per i dispositivi di segnalazione legati all'automazione. Con **ELYPS**, **TWS** e **LUXOR**, Sirena offre una gamma completa volta a soddisfare anche le condizioni più esigenti.

La continua ricerca e sviluppo di nuovi moduli consente inoltre di fornire soluzioni aggiornate in termini di qualità, performance ed efficienza economica.

Con **AUTOMAX** vi garantiamo una gamma di prodotti pensati intorno alle vostre esigenze: progettati, sviluppati e prodotti in Italia, dove, da oltre 40 anni, creiamo i migliori dispositivi di segnalazione industriale del mercato.



SIGNALING FOR THE AUTOMATION INDUSTRY

Since many years, **AUTOMAX** represents a point of reference for signaling devices engineered for industrial automation applications. With **ELYPS**, **TWS** and **LUXOR**, Sirena offers a complete range of products able to satisfy the most critical conditions.

Furthermore, a continuous R+D development, allows to deliver new modules and products, completing the range and upgrading the line to the latest quality and performance standards. With **AUTOMAX**, Sirena guarantees a range of products engineered around your needs.

Since 1974 we engineer, develop and manufacture the best industrial signaling devices on the market. With a 40 years experience and R+D + manufacturing facilities located in Italy, our knowhow and heritage is the added value that we offer in every single product we create.



SIGNALISATION POUR L'INDUSTRIE DE L'AUTOMATISME

Depuis de nombreuses années, **AUTOMAX** représente un point de référence pour les appareils conçus pour les applications de signalisation industrielle.

La gamme **ELYPS**, **TWS** et **LUXOR** proposée par Sirena est un choix complet de produits qui satisfait les conditions les plus sévères.

La recherche et le développement continu de nouveaux éléments nous permet également de fournir les solutions les plus récentes en terme de qualité, performance et d'efficacité économique.









Avec la famille **AUTOMAX** nous vous garantissons une gamme de produits conçus autour de vos besoins ; conçu, développé et fabriqué en Italie, depuis plus de 40 ans, nous créons les meilleurs dispositifs de signalisation industrielle.

ELYPS - TWS - LUXOR

Lo schema seguente mette a confronto la forma, la dimensione, l'intensità luminosa e le tecnologie disponibili delle tre gamme.

 The diagram below compares the shape, size, light intensity and available technologies of the three ranges.

 Le schéma suivant compare la forme, la taille, l'intensité lumineuse et les technologies disponibles des trois gammes.

	ELYPS	TWS	LUXOR
FORMA SHAPE FORME			
	Ellittica / Elliptic / Ellipse	Cilindrica / Cylindric / Cylindrique	Cilindrica / Cylindric / Cylindrique
DIMENSIONI DIMENSIONS DIMENSIONS	70X50 mm	Ø 70 mm Ø 50 mm Ø 36 mm	Ø 136 mm
INTENSITÀ LUMINOSA LIGHT INTENSITY INTENSITE LUMINEUSE	 ELYPS LM  ELYPS LM S  ELYPS LM S MULTI  ELYPS LM X MULTI 	TWS STY/FLA TWS LED TWS LED MULTI TWS S TWS RGA TWS X	LUXOR LED
TECNOLOGIE TECHNOLOGIES TECHNOLOGIES	LED	LED XENON INCANDESCENZA INCANDESCENCE	LED XENON INCANDESCENZA INCANDESCENCE

DIRETTIVA MACCHINE

La Direttiva Macchine 2006/42/CE si riferisce a norme intese a disciplinare l'analisi dei rischi nella progettazione e costruzione di macchine.

La direttiva richiede ai costruttori un'analisi approfondita della sicurezza di macchine e impianti e prevede infatti che vengano inclusi, sin dalla fase di progetto, i dati riguardanti i componenti dei macchinari rilevanti ai fini della sicurezza.

Va, inoltre, specificato che non tutti i dispositivi installati sono direttamente coinvolti in termini di sicurezza del macchinario ed occorre distinguere tra applicazioni rilevanti e non rilevanti ai fini della sicurezza. Per questa ragione, i dispositivi di segnalazione acustica e luminosa utilizzati in numerose applicazioni informative, sono da ritenersi non rilevanti ai fini della sicurezza. Un segnalatore può, ad esempio, semplicemente informare una persona se un processo è in corso o è terminato; spesso serve a riconoscere i fermi macchina ed aumentarne il rendimento.

I segnalatori Sirena sono conformi alla Direttiva Macchine in quanto rispettano tutte le norme relative ai colori e ai segnali di sicurezza e possono essere tranquillamente impiegati dai costruttori di macchine.



MACHINE DIRECTIVE

The 2006/42/EC Machine Directive refers to regulations that cover risk analysis in the design and construction process of machinery.

The directive requires manufacturers to make a detailed analysis regarding the safety of machinery and systems. Data relating to safety of machinery components must also be included at the project stage.

It must be specified that not all devices installed are directly involved in terms of safety of machinery and its applications. It is also necessary to distinguish between relevant and not relevant applications for the purpose of safety. For this reason, the visual and acoustic signaling devices used in numerous informative applications are to be considered not relevant for the purpose of safety. A signal can, for example, simply inform a person if a process is in progress or has been completed; often used to detect downtime and increase productivity.

Sirena's signaling devices comply with the Machinery Directive. They respect all the regulations relating to colors and safety signals and can be used by machine builders.



DIRECTIVE MACHINES

La Directive Machines 2006/42/CE fait référence à des réglementations qui couvrent l'analyse des risques dans la conception et la construction des machines. La directive oblige les fabricants à une analyse détaillée concernant la sécurité des machines et des systèmes ; les données relatives à la sécurité des composants des machines doivent également être inclus au stade du projet.

Il faut préciser que les périphériques installés ne sont pas directement impliqués en termes de sécurité des machines et de ses applications. Il est également nécessaire de faire une distinction entre les applications pertinentes et non pertinentes aux fins de la sécurité. Pour cette raison, les dispositifs visuels et acoustiques de signalisation utilisés dans de nombreuses applications doivent être considérés comme non pertinentes en ce qui concerne la sécurité.

Un signal peut, par exemple, informer tout simplement une personne si un processus est en cours ou a été achevé ; il est souvent utilisé pour détecter les temps d'arrêt ou une productivité accrue.

Les dispositifs de signalisation Sirena se conforment à la Directive Machines. Ils respectent tous les règlements relatifs aux codes couleurs et signaux de sécurité et ils peuvent être utilisés par les constructeurs de machines.

I segnalatori Sirena sono adatti alla segnalazione acustica e luminosa delle macchine in conformità con la Direttiva Europea sui Macchinari 2006/42/CE (29/12/2009).

 **Sirena signaling devices are suitable for visual and acoustic signaling on machinery in conformity with the European Machine Directive 2006/42/EC (29/12/2009).**

 **Les dispositifs de signalisation Sirena sont appropriés pour la signalisation visuelle et acoustique en conformité avec la Directive Européenne 2006/42/CE des Machines (29/12/2009).**

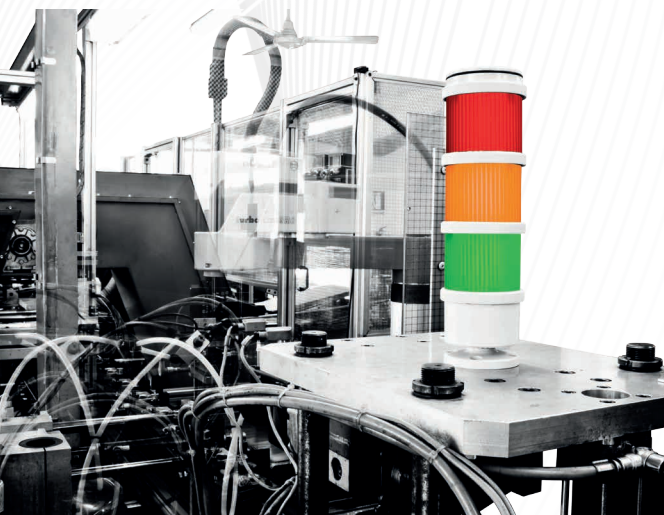

COLORI DEGLI INDICATORI LUMINOSI IEC 60073

IEC 60073 COLOR CODING FOR INDICATORS

LES COULEURS DES INDICATEURS LUMINEUX IEC 60073



CONDIZIONE PERICOLOSA, RICHIEDE INTERVENTO IMMEDIATO

(esempio: pressione/temperatura fuori dagli standard di sicurezza).

- 🇬🇧 **DANGEROUS SITUATION, REQUIRES IMMEDIATE ACTION**
(example: pressure/temperature outwith safety standards).
- 🇫🇷 **SITUATION DANGEREUSE, NECESSITE UNE ACTION IMMEDIATE**
(exemple : pression/température hors de normes de sécurité).



CONDIZIONE ANOMALA, RICHIEDE MONITORAGGIO E/O INTERVENTO

(esempio: nastro trasportatore sovraccarico, richiede intervento per sopprimere la condizione anomala).

- 🇬🇧 **ANOMALY SITUATION, REQUIRES MONITORING AND/OR ACTION**
(example: conveyor belt blocked, intervention required to correct the abnormal situation).
- 🇫🇷 **SITUATION ANORMALE, NECESSITE UNE SURVEILLANCE ET/OU UNE INTERVENTION** (exemple : tapis roulant bloqué, intervention nécessaire pour corriger la situation anormale).



CONDIZIONE CHE RICHIEDE INTERVENTO OBBLIGATORIO

(esempio: inserimento dati necessario a procedere).

- 🇬🇧 **SITUATIONS THAT REQUIRE MANDATORY ACTION**
(example: critical data input necessary to proceed).
- 🇫🇷 **SITUATION QUI NECESSITE UNE INTERVENTION OBLIGATOIRE**
(exemple : entrée de données critique nécessaires pour la procédure).



UTILIZZO IN CASO DI MESSAGGIO DIVERSO DA QUANTO PREVISTO DAI COLORI STANDARD, RICHIEDE MONITORAGGIO

(esempio: macchina alimentata).

- 🇬🇧 **TO BE USED TO COMMUNICATE A MESSAGE DIFFERENT TO THAT FORESEEN BY THE STANDARD COLORS, REQUIRES MONITORING**
(example: machine in function).
- 🇫🇷 **PEUT ÊTRE UTILISE POUR COMMUNIQUER UN MESSAGE DIFFERENT DE CELUI PREVU PAR LES COULEURS STANDARDS, NECESSITE UNE SURVEILLANCE** (exemple : machine en fonction).



CONDIZIONE NORMALE (esempio: autorizzazione a procedere/ macchinario in funzione).

- 🇬🇧 **NORMAL SITUATION** (example: authorization to proceed/machinery in function).
- 🇫🇷 **SITUATION NORMALE** (exemple : autorisation de mise en marche/ machines en fonction).



- Le condizioni più critiche vengono installate nella parte alta della colonna.
- 🇬🇧 The most critical situations are installed at the top part of the stacklight.
- 🇫🇷 Les situations les plus critiques sont installées dans la partie supérieure de la colonne lumineuse.

- Le condizioni meno critiche vengono installate nella parte bassa della colonna.
- 🇬🇧 The less critical situations are installed at the bottom part of the stacklight.
- 🇫🇷 Les situations moins critiques sont installées dans la partie inférieure de la colonne lumineuse.

AUTOMAX

Le colonne **ELYPS** e **TWS** nascono per venire incontro alle esigenze dell'utilizzatore e, come per tutti i prodotti Sirena, la priorità è quella di offrire un prodotto customizzato per l'applicazione finale piuttosto che un prodotto standard che spesso si inserisce come compromesso all'interno del progetto. Per questo motivo Sirena ha sviluppato 3 tipologie di lente per far fronte ad utilizzi in ambientazioni particolari della colonna.

🇬🇧 Sirena's priority is to offer customers with a customized product tailored for the final application rather than offering a standard product that is often a compromise to what is actually needed. **ELYPS** and **TWS** stacklights have been engineered specifically to meet the end-user requirements: for this reason Sirena has developed 3 types of lenses engineered for specific applications according to the surrounding environment.

🇫🇷 La priorité de Sirena est d'offrir aux clients un produit personnalisé sur mesure pour l'application finale plutôt que d'offrir un produit standard qui est souvent un compromis à ce qui est réellement nécessaire. Les colonnes lumineuses **ELYPS** et **TWS** ont été conçues spécifiquement pour répondre aux besoins des utilisateurs finaux ; pour cette raison Sirena a développé 3 types de lentilles pour des applications spécifiques en fonction de l'environnement.

allCOLOR

La lente **allCOLOR** nasce per l'utilizzo standard dove la brillantezza del colore del modulo luminoso è una priorità. La lente **allCOLOR** sfrutta la tecnologia colore-su-colore, dove il colore specifico della lente del modulo viene sostenuto da una fonte luminosa con la medesima colorazione. Questo processo consente di ottimizzare le frequenze di emissione e di evitare l'effetto filtro della lente stessa. In questo modo si ottengono colori più vivi e brillanti, idonei a garantire quanto stabilito dalla Direttiva Macchine.

🇬🇧 The **allCOLOR** lens has been developed for standard applications where the brightness of the color is the main priority. The light output of the colored lens is intensified by using the same color light source (color-on-color technology). This process allows optimization of the emission frequencies avoiding the filter effect of the lens. The color is, therefore, more vivid than a standard stacklight guaranteeing compliance with the Machine Directive specifications.

🇫🇷 La lentille **allCOLOR** a été développée pour les applications standards où la luminosité de la couleur est la principale priorité. L'intensité lumineuse de la lentille colorée est soutenue à l'aide d'une source lumineuse de même couleur (technologie couleur-sur-couleur). Ce procédé permet d'optimiser les fréquences d'émission en évitant l'effet de filtrage de la lentille. La couleur est donc plus vive qu'une colonne lumineuse standard et conforme aux spécifications de la Directive Machine.



UTILIZZO STANDARD - Lente colorata con fonte luminosa colorata. La stessa colorazione tra fonte luminosa e cupola permette l'ottimizzazione della frequenza di emissione permettendo di raggiungere una brillantezza unica.

🇬🇧 **STANDARD USE - Colored lens with colored light source.** The use of a colored lens with the same-color light source allows optimization of the emission frequency producing a rich intense light output.

🇫🇷 **UTILISATION STANDARD - Lentille colorée et source lumineuse colorée.** L'utilisation d'une lentille colorée de la même couleur que la source lumineuse permet l'optimisation de la fréquence d'émission produisant une luminosité très intense et riche.

allCLEAR

La lente **allCLEAR** nasce per l'utilizzo in ambienti ad alta luminosità dove la priorità assoluta è quella di fornire all'operatore un'informazione corretta in merito allo status del macchinario. In ambienti ad alta luminosità può verificarsi che la luce ambientale si inserisca nel modulo della colonna che, se dotata di lente colorata, darà l'impressione di essere accesa o per lo meno potrebbe creare confusione: questa condizione è nota come "effetto phantom". La lente **allCLEAR**, dotata di fonte luminosa colorata e di lente di colore neutro, elimina questa possibilità, essendo appunto di colore bianco/neutro quando spenta e del colore designato una volta accesa.

🇬🇧 The **allCLEAR** lens has been developed for use in bright environments where the main priority is to give a precise signal regarding machine status to the operator. In very bright environments, the ambient light can cause confusion as to the ON/OFF state of the colored module: this condition is known as "phantom effect". The **allCLEAR** lens, with colored light LED source eliminates this possibility. When the module is switched OFF the lens is white/neutral and when it is switched ON the lens lights up according to the color of LEDs inside the module.

🇫🇷 La lentille **allCLEAR** a été développée pour une utilisation dans les environnements lumineux où la priorité est de donner un signal précis à l'opérateur à propos du fonctionnement de la machine. Dans les environnements très lumineux, la lumière d'ambiance peut causer de la confusion quant à l'état ON/OFF de l'élément coloré : cette condition est connue comme "effet fantôme". La lentille **allCLEAR**, avec source lumineuse colorée LED élimine cet effet. Lorsque l'élément est éteint la lentille est blanche/neutre et quand il est allumé, la lentille s'allume en fonction de la couleur de la LED à l'intérieur.



AMBIENTI CON ALTA LUMINOSITÀ - Lente neutra con fonte luminosa colorata. In ambienti con luminosità molto alta è possibile che la luminosità ambientale stessa illumini il modulo spento creando problemi nella distinzione tra lo stato ON e OFF della colonna (effetto phantom). Il modulo con colorazione neutra permette una netta distinzione tra lo status ON e OFF della colonna.

🇬🇧 **USE IN VERY BRIGHT ENVIRONMENTS - Clear lens with colored light source.** In very bright environments, it is possible that the ambient brightness lights up the module when it is switched OFF creating problems in distinguishing between the ON and OFF state of the stacklight (phantom effect). The clear lens module allows clear distinction between the ON and OFF status of the stacklight.

🇫🇷 **UTILISATION DANS DES ENVIRONNEMENTS TRÈS LUMINEUX - Lentille transparente avec source lumineuse colorée.** Dans les environnements très lumineux, il est possible que la luminosité ambiante éclaire l'élément quand il est éteint en créant de la confusion à distinguer entre l'état ON et OFF de la colonne lumineuse (effet fantôme). La lentille claire de l'élément permet la bonne distinction entre l'ON ou OFF.

PROXIMITY

La lente **PROXIMITY** nasce per l'utilizzo della colonna luminosa in prossimità dell'operatore. Sviluppata con una particolare miscela di policarbonato dalla caratteristica opalina, la lente **PROXIMITY** consente di segnalare senza abbagliare, permettendo all'operatore, che si trova in prossimità della colonna luminosa, di prendere atto dello status della macchina senza che la sua attenzione venga distolta a causa di una segnalazione di intensità luminosa maggiore di quella effettivamente necessaria.

🇬🇧 The **PROXIMITY** lens has been developed for use in areas where the stacklight is installed near the operator. Made with a mixture of opaline polycarbonate, this lens allows a signal to be given without dazzling. The operator located in the vicinity of the tower is, therefore, notified of the status of the machine without his attention being diverted by a light intensity greater than that actually required.

🇫🇷 La lentille **PROXIMITY** a été développée pour une utilisation dans les zones où la colonne lumineuse est installée près de l'opérateur. Fabriqué avec un mélange de polycarbonate opale, cette lentille permet l'émission d'un faisceau lumineux qui n'éblouit pas l'opérateur. L'opérateur situé à proximité de la colonne lumineuse est, par conséquent, informé de l'état de la machine sans que son attention soit détournée par une intensité lumineuse supérieure à celle réellement nécessaire.



UTILIZZO IN PROSSIMITÀ DELL'OPERATORE - Lente colorata opalina con fonte luminosa colorata. Ideale per la segnalazione in prossimità dell'operatore in quanto la particolare caratteristica opalina permette una colorazione ottimale evitando di disturbare l'operatore.

🇬🇧 **USE NEAR THE OPERATOR - Opaline colored lens with colored light source.** Ideal when the tower is installed near the operator. The opaline characteristic allows an optimal signaling function yet without disturbing.

🇫🇷 **UTILISATION PRES DE L'OPERATEUR - Lentille colorée opaline avec source lumineuse colorée.** Idéale lorsque la colonne lumineuse est installée près de l'opérateur. La caractéristique de la couleur opaline permet un fonctionnement de signalisation optimal sans déranger l'opérateur.

all COLOR

TWS S

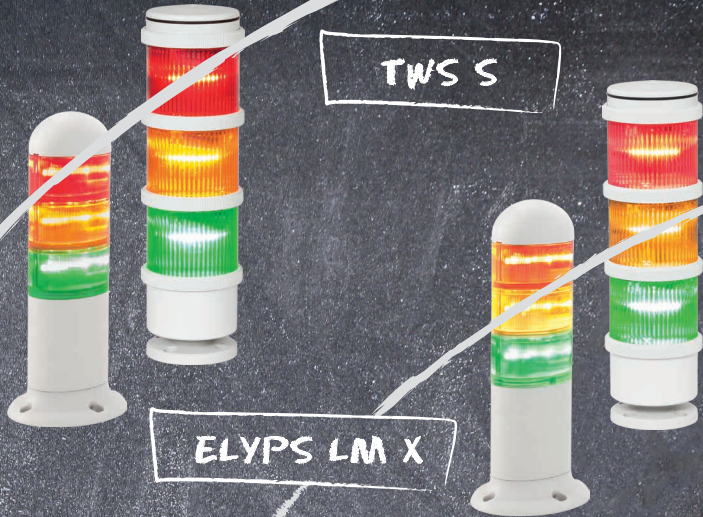

ELYPS LM X

all CLEAR

TWS LED



ELYPS LM S

LONTANO / FAIR / LOIN

STANDARD

LUMINOSO
BRIGHT
LUMINEUX

STANDARD

LUMINOSITÀ AMBIENTE
AMBIENCE BRIGHTNESS
LUMINOSITE AMBIANTE

TWS LED
ELYPS LM
PROXIMITY

VICINO
NEAR
PROCHE



DISTANZA TRA L'OPERATORE E LA TORRETTA
DISTANCE BETWEEN OPERATOR AND STACKLIGHT
LA DISTANCE ENTRE L'OPERATEUR ET LA COLONNE LUMINEUSE

GAMMA ELYPS

La missione quotidiana di Sirena è molto semplice: creare dispositivi per la segnalazione acustica e luminosa innovativi e di qualità.

In Sirena siamo abituati ad indicare la strada da seguire, siamo consci del nostro dovere, delle nostre responsabilità. Il nostro mestiere coincide con la nostra vocazione: definire gli standard della segnalazione acustica e luminosa.

Quando abbiamo deciso di disegnare una nuova linea di colonne luminose, non ci siamo fermati ad una semplice revisione delle gamme esistenti ma ci siamo posti come obiettivo quello di rivoluzionare il concetto in essere.

Abbiamo pensato ad una forma innovativa, esteticamente rivoluzionaria, in grado di racchiudere gli standard dimensionali più diffusi. Abbiamo pensato ad un'ottica brevettata in grado di far performare la colonna a 360 gradi. Abbiamo pensato ad elettroniche di eccellenza in grado di soddisfare tutte le Vostre esigenze. Abbiamo pensato a tre filosofie di cablaggio che possano massimizzare il valore aggiunto della colonna. Abbiamo pensato a cinque basi di fissaggio uniche in grado di soddisfare le situazioni più esigenti. Prima di tutto però, abbiamo pensato a Voi.

Abbiamo fatto tutto questo perché il nostro lavoro è far sì che il Vostro lavoro diventi semplice ed efficace. Perché sappiamo quanto sia importante metterVi nella condizione di creare valore aggiunto. Perché sappiamo quanta fiducia riponete in noi, una fiducia che non a caso si rinnova da più di 40 anni.



ELYPS RANGE

Sirena has a very simple mission: to create innovative and high-quality visual and acoustic signaling devices.

At Sirena, we're used to indicating the path to follow, we're aware of our duties as well as our responsibilities. Our job matches our vocation: defining the standards of the signaling industry.

When we decided to engineer a new range of stacklights, we did not settle down with a simple redesign of the market standards but instead we've taken the challenge to revolutionize the concept at its very roots.

We thought about a stacklight with an innovative shape, aesthetically revolutionary, capable of satisfying the most common dimensional standards. We thought about patented optics capable of performing at 360 degrees. We thought about state-of-the-art electronics capable of satisfying your needs. We thought about three different configuration philosophies capable of increasing the added value of the stacklight. We thought about five unique mounting bases capable of solving the most challenging installation issues. But, more than everything else, we thought about You.

We've done all this because our job is to make sure your job becomes as easy and efficient as possible. Because we understand how important it is to put You in the condition to create added value. Because we know how much You trust us and because we're flattered you've been doing so for the past 40 years.



GAMME ELYPS

L'objectif quotidien de Sirena : créer des dispositifs acoustiques et lumineux innovants et de qualité.

Sirena, précurseur de la conception de produits et de technologies du futur développe ses produits dans le respect des normes standards de l'industrie de la signalisation.

Lors de la conception de notre nouvelle gamme de colonnes lumineuses, nous ne nous sommes pas arrêté à un simple examen des standards existants, nous avons pris le défi d'en révolutionner le concept.

Nous avons pensé à une colonne lumineuse d'une forme innovante, esthétiquement révolutionnaire, conforme aux standards dimensionnelles. Nous avons pensé à une optique brevetée capable d'être performante sur 360 degrés. Nous avons pensé à une électronique capable de répondre à toutes vos exigences.

Nous avons pensé à trois philosophies de configuration différentes capables d'optimiser la valeur ajoutée de la colonne lumineuse. Nous avons pensé à limiter à cinq bases de fixation capables de répondre aux situations les plus divers. Mais d'abord, nous avons pensé à Vous.

La colonna luminosa modulare **ELYPS** è formata da quattro gruppi di moduli: le basi di fissaggio, i moduli di cablaggio, i moduli luminosi ed i moduli acustici.

Le basi di fissaggio **MB** consentono di installare la colonna nelle condizioni più varie per consentirVi di disporre sempre della posizione ottimale del dispositivo.

I moduli di cablaggio **WM** permettono di scegliere le tensioni operative e la filosofia di funzionamento, possiamo creare infatti dispositivi a bassa o ad alta tensione, a luce fissa o lampeggiante, con la possibilità di controllare il lampeggio (via PLC) direttamente dal modulo di cablaggio o scegliere l'opzione preimpostata sul modulo luminoso.

I moduli luminosi **LM** sono stati concepiti per soddisfare le esigenze più varie. Diversi livelli di luminosità, diverse tipologie di lente (**allCOLOR**, **allCLEAR**, **PROXIMITY**) e diverse tipologie di lampeggio, offrono un range unico e completo.

I moduli acustici **AM** offrono due tecnologie di funzionamento: piezoelettrico e magnetodinamico. Entrambe le versioni sono provviste di due canali acustici consentendo alla colonna di performare due tipologie di suono a seconda del messaggio da comunicare.

Il grado di protezione **IP66** rende inoltre **ELYPS** eccellente anche per applicazioni all'esterno.

ELYPS è disponibile in colorazione **allGRAY** (industriale RAL 7035) e **allBLACK** (industriale/commerciale RAL 9005).



The **ELYPS** modular stacklight range is made of four groups of modules: mounting bases, wiring modules, light modules and acoustic modules.

MB Mounting Bases are engineered for a versatile stacklight installation, allowing the devices to be installed always in the ideal position.

WM Wiring Modules allow to choose voltages as well as the configuration philosophy, giving the possibility to create low or high tension devices, with steady or flashing light and with the possibility to control the flashing pattern (i.e. via PLC) directly from the base of the stacklight.

LM Light Modules have been engineered to satisfy all possible needs. Different levels of light intensity as well as different lenses technology (**allCOLOR**, **allCLEAR**, **PROXIMITY**) and different flashing patterns, offer a unique and complete range.

AM Acoustic Modules are based on two technologies: piezoelectric and magnetodynamic. Both versions allow the use of two separate channels giving the possibility of utilizing the stacklight with two different sounds, according to the type of message one needs to deliver.

The **IP66** protection grade makes **ELYPS** ideal also for outdoor applications.

ELYPS is available in two color options: **allGRAY** (industrial RAL 7035) and **allBLACK** (industrial/commercial RAL 9005).



La palette des colonnes lumineuses modulaires **ELYPS** est constituée par quatre groupes d'éléments : bases de fixation, éléments de câblage, éléments lumineux et éléments acoustiques.

Les Bases de Fixation **MB** sont conçues pour l'installation d'une colonne lumineuse polyvalente, ce qui permet aux dispositifs d'être installés toujours dans la position idéale.

Les Eléments de Câblage **WM** permettent de choisir les tensions de fonctionnement, ainsi que la configuration, ce qui donne la possibilité de créer des dispositifs basse ou haute tension, à lumière fixe ou clignotante et avec le moyen de contrôler, directement, à partir de la base **WM**, le mode clignotant (par PLC). Les Eléments Lumineux **LM** sont conçus pour répondre aux besoins les plus divers. Les niveaux d'intensité d'éclairage ainsi que les différents lentilles (**allCOLOR**, **allCLEAR**, **PROXIMITY**) et les différents types de flash, offrent une gamme complète et unique.

Les Eléments Acoustiques **AM** sont repartis sur deux technologies : piézoélectrique et magnétodynamique.

Les deux versions permettent l'utilisation de deux canaux acoustiques séparés donnant la possibilité d'utiliser la colonne lumineuse avec deux types de son différents, en fonction du message.

Le degré de protection **IP66** rend **ELYPS** idéal pour les applications à l'extérieur.

ELYPS est disponible en couleurs : **allGRAY** (RAL 7035) et **allBLACK** (RAL 9005).



3 FILOSOFIE DI CONFIGURAZIONE

La colonna luminosa modulare **ELYPS** dispone di tre filosofie di configurazione in base alle esigenze dell'applicazione finale. A seconda della necessità o meno di avere moduli lampeggianti si può scegliere se generare la sequenza di lampeggio direttamente da PLC o se utilizzare le sequenze preimpostate nel modulo luminoso, semplificando le operazioni di programmazione e gestione. È inoltre possibile variare la funzione di ciascun modulo da fisso a lampeggiante anche senza la programmazione del PLC, utilizzando uno dei moduli di cablaggio WM MULTI e variando lo status di ciascun modulo in modo diretto tramite contatto elettrico.

3 CONFIGURATION PHILOSOPHIES

ELYPS modular stacklight allows three different configuration philosophies according to the final application. Depending on the need to have one or more flashing modules, it is possible to choose whether to generate the flashing pattern directly via a PLC (using a steady light stacklight) or whether to use the preset flashing patterns of each module, easing PLC programming and management operations. Furthermore, it is possible to change the status of each module from steady to flashing even without the use of a PLC, by using a flashing wiring module (WM MULTI) and controlling the status of each module via a single independent electrical contact on the wiring module itself (BLINK channel).

3 PHILOSOPHIES DE CONFIGURATION

Les colonnes lumineuses **ELYPS** permettent trois différentes philosophies de configuration en fonction des exigences de l'application. En fonction de la nécessité ou non de disposer d'un ou plusieurs éléments de clignotement, il est possible de choisir si vous souhaitez générer la séquence de clignotement directement par le PLC ou si vous voulez utiliser les séquences prédéfinies dans l'élément lumineux, ce qui facilitera la programmation des PLCs et les opérations de gestion pour générer le motif clignotant. Il est également possible de modifier l'état de chaque élément (de fixe à clignotant) même sans l'utilisation du PLC en utilisant l'élément de câblage clignotant (WM MULTI) et contrôlant l'état sur chaque élément directement par contact électrique.

○ COLONNA A LUCE FISSA

La colonna a luce fissa è composta da un Modulo di Cablaggio WM LT o HT e da Moduli Luminosi (max. 6) a luce fissa LM o LM S a seconda della luminosità prescelta. I moduli della colonna a luce fissa possono essere controllati direttamente o tramite PLC.

🇬🇧 STEADY LIGHT STACKLIGHT

The steady light stacklight consists of one wiring module WM LT or HT and up to 6 steady light modules LM or LM S, according to the light intensity required. Each light module can be controlled directly via electrical contacts or via PLC.

🇮🇹 COLONNA LUMINEUSA A LUMIERE FISSA

La colonna luminosa a luce fissa è composta da un elemento di cablaggio WM LT o HT e da elementi luminosi (max. 6) a luce fissa LM o LM S in funzione della luminosità scelta. Gli elementi della colonna luminosa possono essere gestiti sia direttamente, sia tramite PLC.

□ COLONNA A LUCE LAMPEGGIANTE

La colonna a luce lampeggiante è composta da un Modulo di Cablaggio WM LT o HT e da Moduli Luminosi (max. 6) a luce lampeggiante LM S MULTI o LM X MULTI (4 tipologie di lampeggio preimpostate selezionabili tramite dip-switch) a seconda della luminosità prescelta. I moduli della colonna a luce lampeggiante possono essere attivati direttamente o tramite PLC: la tipologia di lampeggio sarà quella preimpostata su ciascun modulo.

🇬🇧 FLASHING LIGHT STACKLIGHT

The flashing light stacklight consists of one wiring module WM LT or HT and up to 6 flashing light modules LM S MULTI or LM X MULTI (4 preset flashing patterns selectable via dip-switch), according to the light intensity required. Each light module can be controlled directly via electrical contacts or via PLC. The flashing pattern will be the one selected on each module.

🇮🇹 COLONNA LUMINEUSA A LUMIERE CLIGNOTANTE

La colonna luminosa a luce clignotante si compone di un elemento di cablaggio WM LT o HT e da elementi luminosi (max. 6) LM S MULTI o LM X MULTI (4 tipi d'effluvi a selezionare per dip-switch), in funzione dell'intensità della luce scelta. Ogni elemento luminoso può essere controllato direttamente via contatti elettrici o tramite PLC, il tipo di clignotamento sarà quello che è stato selezionato su ogni elemento.

△ COLONNA CON CONTROLLO DEL LAMPEGGIO NELLA BASE

Questa colonna è composta da un Modulo di Cablaggio con funzione lampeggiante WM LT MULTI o HT MULTI (4 tipologie di lampeggio preimpostate selezionabili tramite dip-switch) e da Moduli Luminosi (max. 6) a luce fissa LM o LM S a seconda della luminosità prescelta. Per ogni modulo è possibile attivare la funzione luce fissa o lampeggiante controllando i contatti elettrici ed il contatto BLINK (lampeggio) del modulo di cablaggio in modo diretto o tramite PLC.

🇬🇧 STACKLIGHT WITH FLASHING CONTROLS IN THE BASE

The stacklight with flashing controls in the base consists of one wiring module with flashing options WM LT MULTI or HT MULTI (4 preset flashing patterns selectable via dip-switch) and by up to 6 steady light modules LM or LM S, according to the light intensity required. For each light module it is possible to change the status from steady to flashing by controlling the electrical contacts and the BLINK channel (flashing) on the base directly or via PLC.

🇮🇹 COLONNA LUMINEUSA AVEC CONTRÔLE DU CLIGNOTEMENT DANS LA BASE

La colonna luminosa è costituita da un elemento di cablaggio con funzione clignotante WM LT MULTI o HT MULTI (4 tipi d'effluvi a selezionare per dip-Switch) e fino a 6 elementi luminosi fissi LM o LM S, in funzione dell'intensità luminosa richiesta. Per ogni elemento luminoso, è possibile di cambiare lo status di fisso a clignotante in controllando i contatti elettrici e il canale BLINK (clignotamento) sulla base, direttamente o tramite l'intermediario dell'automate (PLC).



Per ciascuna tipologia è possibile aggiungere il Modulo Acustico AM o AM S mentre l'utilizzo di una Base di Fissaggio è obbligatorio.

🇬🇧 For each configuration philosophy it is possible to add an acoustic module AM or AM S. The use of a mounting base MB is mandatory.

🇮🇹 Pour chaque philosophie de configuration, il est possible d'ajouter un élément acoustique AM ou AM S. L'utilisation d'une base de fixation MB est obligatoire.

AM
MODULO ACUSTICO
ACOUSTIC MODULE
ELEMENT ACOUSTIQUE

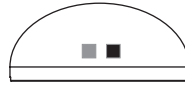

Cappello di chiusura (fornito con modulo WM) si utilizza in assenza di modulo acustico

Top cap for closure when the acoustic module is not installed (supplied with each WM module)

Couvercle, à utiliser lorsque l'élément acoustique n'est pas installé (fourni avec l'élément WM)

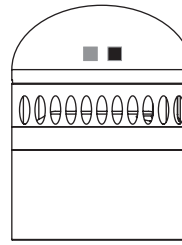

AM

Modulo acustico piezoelettrico
Piezoelectric acoustic module
Élément acoustique piézoélectrique

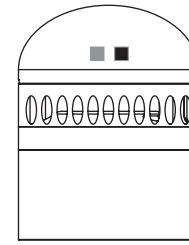

AM S

Modulo acustico magnetodinamico
Magnetodynamic acoustic module
Élément acoustique magnétodynamique

LM
MODULO LUMINOSO
LIGHT MODULE
ELEMENT LUMINEUX



LM

Modulo luminoso a luce fissa
LED steady light module
Élément LED lumière fixe



LM S

Modulo extra luminoso a luce fissa
Bright LED steady light module
Élément LED extra lumineux lumière fixe



LM S MULTI

Modulo extra luminoso multifunzione (4 tipi di lampeggio)
Bright LED multifunctional light module (4 light effects)
Élément LED lumineux multifonction (4 effets lumineux)



LM X MULTI

Modulo superluminoso multifunzione (4 tipi di lampeggio)
Superbright LED multifunctional light module (4 light effects)
Élément LED extra lumineux multifonction (4 effets lumineux)

WM
MODULO DI CABLAGGIO
WIRING MODULE
ELEMENT DE CABLAGE

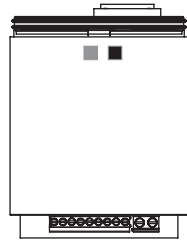

WM LT

Modulo cablaggio 12/24V ACDC
Wiring module 12/24V ACDC
Élément de câblage 12/24V ACDC

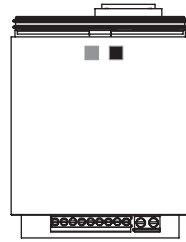

WM HT

Modulo cablaggio 120/240V AC
Wiring module 120/240V AC
Élément de câblage 120/240V AC

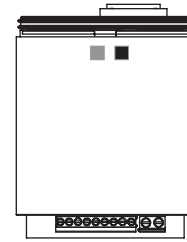

WM LT MULTI

Modulo cablaggio 12/24V ACDC multifunzione (4 tipi di lampeggio)
Multifunctional wiring module 12/24V ACDC (4 light effects)
Élément de câblage multifonctionnel 12/24V ACDC (4 effets lumineux)

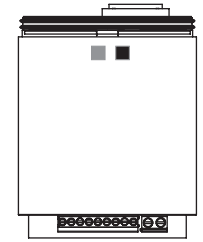

WM HT MULTI

Modulo cablaggio 120/240V AC multifunzione (4 tipi di lampeggio)
Multifunctional wiring module 120/240V AC (4 light effects)
Élément de câblage multifonctionnel 120/240V AC (4 effets lumineux)

MB
BASE DI FISSAGGIO
MOUNTING BASE
BASE DE FIXATION

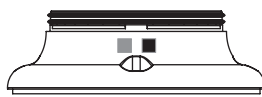

MB FLAT

Montaggio su superficie piana
Flat surface mounting
Montage à plat

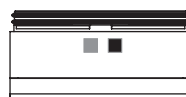

MB WALL

Montaggio laterale/parete
Lateral/wall mounting
Montage sur surfaces latérales



MB POLE

Montaggio su palo/tubo filettato 1/2" NPT-F
Installation on a 1/2" NPT-F threaded pole
Fixation sur un mât avec filetage 1/2" NPT-F

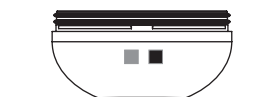

MB EXTENDED

Montaggio su superficie piana (rialzato 10 cm)
Flat surface mounting (stacklight position lifted by 10 cm)
Montage à plat (la position de la colonne lumineuse est soulevée de 10 cm)



MB TUBE

Montaggio su superficie piana con prolunga INOX (lunghezze disponibili 10, 20, 30, 40 cm)
Flat surface mounting with Stainless Steel extension tube (lengths available 10, 20, 30, 40 cm)
Montage à plat avec un mât d'extension en acier inoxydable (longueurs disponibles 10, 20, 30, 40 cm)

○ Segui il **CERCHIO** per configurare la **colonna a luce fissa**
Follow the **CIRCLE** to configure a **steady light stacklight**
Suivez le **CERCLE** pour configurer la **colonne lumineuse fixe**

□ Segui il **QUADRATO** per configurare la **colonna a luce lampeggiante**
Follow the **SQUARE** to configure a **flashing light stacklight**
Suivez le **CARRE** pour configurer la **colonne lumineuse clignotante**

△ Segui il **TRIANGOLO** per configurare la **colonna con controllo del lampeggio nella base**
Follow the **TRIANGLE** to configure a **stacklight with flashing controls in the base**
Suivez le **TRIANGLE** pour configurer la **colonne lumineuse avec contrôle du clignotement dans la base**

ELYPS WM



ELYPS WM
ELYPS WM MULTI

Corpo / Body / Corps



WM MULTI

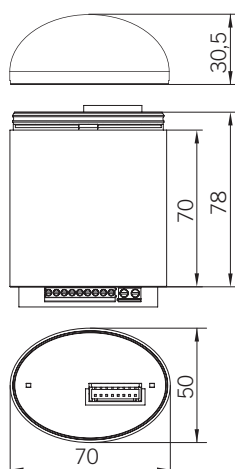

Codici / Codes

ELYPS WM

LT	12/24V ACDC	32457	32458
HT	120/240V AC	32320	32321
LT MULTI	12/24V ACDC	32467	32468
HT MULTI	120/240V AC	32326	32327

Modulo di cablaggio disponibile nelle versioni **ELYPS WM** e **ELYPS WM MULTI**, fornite con cappello per la chiusura superiore della colonna, nel caso non venga impiegato il modulo acustico.

ELYPS WM

Modulo per il cablaggio della colonna luminosa ELYPS. Dispone di un contatto comune + 7 contatti indipendenti per consentire l'assemblaggio di un massimo di 7 moduli: 6 moduli luminosi + 1 modulo acustico (1 canale) o 5 moduli luminosi + 1 modulo acustico (2 canali).

ELYPS WM MULTI

Stesse caratteristiche primarie del modulo WM, **WM MULTI** offre la possibilità di generare il lampeggio dei moduli luminosi installati tramite un apposito canale BLINK (lampeggio). Il canale BLINK può essere attivato in modo indipendente per ciascun modulo, consentendo la variazione da luce fissa a lampeggiante durante l'utilizzo della colonna. Il controllo del canale BLINK può avvenire sia direttamente che tramite PLC.

Tensione operativa

WM LT e **WM LT MULTI**: 12/24V ACDC

WM HT e **WM HT MULTI**: 120/240V AC

Caratteristiche meccaniche

Polycarbonato autoestinguente ad alta resistenza agli impatti, adatto per utilizzo esterno grazie al grado di protezione IP66, UL TYPE 4X, garantito dalla guarnizione di tenuta in silicone presente su ogni modulo.

Caratteristiche luminose

WM LT MULTI e **WM HT MULTI**

Dispone di 4 effetti luminosi: flash singolo (1F), doppio flash (2F), triplo flash (3F) e stroboscopico (5F) selezionabili tramite dip-switch.

Certificazioni / Certifications



Wiring module available in the following versions: **ELYPS WM** and **ELYPS WM MULTI**, supplied with a top cap for closure of the stacklight when an acoustic module is not installed.

ELYPS WM

Wiring module for the ELYPS stack light range. With 7 electrical contacts, it allows assembly of maximum 7 modules: 6 light modules + 1 acoustic module (1 channel) or 5 light modules + 1 acoustic module (2 channels).

ELYPS WM MULTI

With the same main characteristics of the WM module, **WM MULTI** allows the possibility of generating a flashing sequence in any of the installed module via the activation of dedicated BLINK channel. The BLINK channel can be triggered independently for each module, allowing the change from steady to flashing light also during the normal operations of the stack light. The BLINK channel activation can be done directly as well as via PLC.

Voltagés

WM LT and **WM LT MULTI**: 12/24V ACDC

WM HT and **WM HT MULTI**: 120/240V AC

Mechanical features

Self-extinguishing PC body with high impact resistance, suitable for outdoor applications thanks to the IP66, UL TYPE 4X protection grade, assured by the silicon gasket on each module.

Optical features

WM LT MULTI and **WM HT MULTI**

Enriched by 4 light effects: single flash (1F), double flash (2F), triple flash (3F) and stroboscopic (5F) selectable via dip-switch.



Élément de câblage disponible en version **ELYPS WM** ou **ELYPS WM MULTI**, fournies avec un couvercle de fermeture à utiliser quand l'élément acoustique n'est pas installé.

ELYPS WM

Élément de câblage de la colonne lumineuse ELYPS. Il prévoit 7 connexions électriques permettant le montage au maximum de 7 éléments : 6 éléments lumineux + 1 élément acoustique (1 canal) ou 5 éléments lumineux + 1 élément acoustique (2 canaux).

ELYPS WM MULTI

Mêmes caractéristiques principales que l'élément WM, le **WM MULTI** permet la sélection d'une séquence de clignotement dans l'un des quelconque des éléments installés par activation d'un canal BLINK dédié. Le canal BLINK peut être déclenché indépendamment dans chaque élément, permettant de changer de lumière fixe à la lumière clignotante pendant les opérations normales de la colonne lumineuse. L'activation du canal peut être faite directement ainsi que par PLC.

Tension d'utilisation

WM LT et **WM LT MULTI** : 12/24V ACDC

WM HT et **WM HT MULTI** : 120/240V AC

Caractéristiques mécaniques

Polycarbonate autoextinguible, haute résistance aux chocs, adapté pour une utilisation à l'extérieur grâce au degré de protection IP66, UL TYPE 4X, garanti par un joint en silicone sur chaque élément.

Caractéristiques optiques

WM LT MULTI et **WM HT MULTI**

Il dispose de 4 effets lumineux : simple éclat (1F), double éclat (2F), triple éclat (3F) et stroboscopique (5F) sélectionnables par dip-switch.

ELYPS LM



ELYPS LM

Cupole / Domes / Dômes

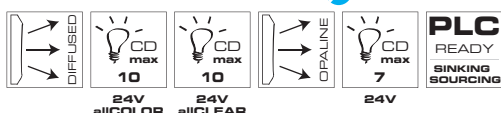

ELYPS LM + ELYPS WM

V DC	12	-	24	-	-	-
V AC	-	12	-	24	120	240
mA	40	60	35	75	30	25

ELYPS LM + ELYPS WM MULTI

V DC	12	-	24	-	-	-
V AC	-	12	-	24	120	240
mA	55	120	50	110	30	25

Codici / Codes

ELYPS LM

	allCOLOR		allCLEAR		PROXIMITY	
	12V	24V	12V	24V	12V	24V
●	32461	32331	32451	32341	32471	32411
●	32462	32332	32452	32342	32472	32412
●	32463	32333	32453	32343	32473	32413
●	32464	32334	32454	32344	32474	32414
●	32465	32335	32455	32345	32475	32415
○	32466	32336	32466	32336	32476	32416

Modulo luminoso a luce fissa a LED integrato. ELYPS LM offre una manutenzione teoricamente nulla grazie alla tecnologia a LED che garantisce 100.000* ore d'utilizzo. Disponibile con lente allCOLOR, allCLEAR e PROXIMITY.

* In condizioni normali, in assenza di vibrazioni e sbalzi di temperatura

Tensione operativa

A seconda del modulo di cablaggio WM selezionato:
con WM LT e WM LT MULTI: 12V ACDC, 24V ACDC
con WM HT e WM HT MULTI: 120/240V AC

Caratteristiche meccaniche

Polycarbonato autoestinguente ad alta resistenza agli impatti, adatto per utilizzo esterno grazie al grado di protezione IP66, UL TYPE 4X, garantito dalla guarnizione di tenuta in silicone presente su ogni modulo.

Caratteristiche luminose

6x LED (3 per lato) a luce fissa. Lente con rigatura verticale per una perfetta distribuzione della luce a 360°.

Disponibile con 3 tipi di lente: allCOLOR (lente colorata con fonte luminosa colorata), allCLEAR (lente neutra con fonte luminosa colorata) e PROXIMITY (lente colorata opalina con fonte luminosa colorata), vedi pagina 132.

Certificazioni / Certifications

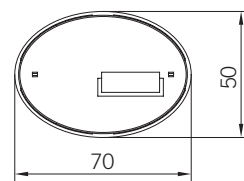
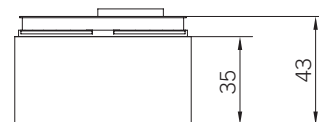

LM



Integrated LED steady light module. ELYPS LM offers virtually zero maintenance thanks to the built-in LED technology that guarantees up to 100.000* hours of product life.

Available with allCOLOR, allCLEAR and PROXIMITY lens.

* At normal conditions, without vibrations and heavy temperature changes

Voltages

According to selected Wiring Module (WM) with WM LT and WM LT MULTI: 12V ACDC, 24V ACDC with WM HT and WM HT MULTI: 120/240V AC

Mechanical features

Self-extinguishing PC body with high impact resistance, suitable for outdoor use thanks to the IP66, UL TYPE 4X protection grade, assured by the silicon gasket on each module.

Optical features

6x LEDs (3 per side) producing steady light. The vertically lined lens allows a perfect light distribution over 360°.

Available with 3 different lens types, allCOLOR (colored lens with colored light source), allCLEAR (clear lens with colored light source) and PROXIMITY (opaline colored lens with colored light source), see page 132.



Élément lumineux à LED intégrées, lumière fixe. ELYPS LM offre un entretien quasi-nul grâce à la technologie intégrée du LED qui garantit jusqu'à 100.000* heures de vie au produit.

Disponible avec lentille allCOLOR, allCLEAR et PROXIMITY.

* Dans des conditions normales, sans vibrations et sans variations importantes de température

Tension d'utilisation

En fonction de l'élément de câblage WM choisi : avec WM LT et WM LT MULTI : 12V ACDC, 24V ACDC avec WM HT et WM HT MULTI : 120/240V AC

Caractéristiques mécaniques

Polycarbonate autoextinguible, haute résistance aux chocs, adapté pour une utilisation à l'extérieur grâce au degré de protection IP66, UL TYPE 4X, garanti par un joint en silicone sur chaque élément.

Caractéristiques optiques

6x LED (3 pour chaque côté) à lumière fixe. La lentille striée en verticale permet une répartition parfaite de la lumière sur 360°.

Disponible avec 3 différents types de lentilles : allCOLOR (lentille colorée et source lumineuse colorée), allCLEAR (lentille incolore transparente avec source lumineuse colorée) et PROXIMITY (lentille opaline colorée avec source lumineuse colorée), voir page 132.

ELYPS LM S



ELYPS LM S

Cupole / Domes / Dômes

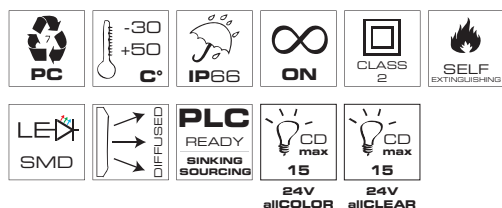

ELYPS LM S + ELYPS WM

V DC	12	-	24	-	-	-
V AC	-	12	-	24	120	240
mA	70	75	50	60	35	25

ELYPS LM S + ELYPS WM MULTI

V DC	12	-	24	-	-	-
V AC	-	12	-	24	120	240
mA	40	110	70	100	35	25

Codici / Codes

ELYPS LM S

	allCOLOR	allCLEAR
●	32371	32381
●	32372	32382
●	32373	32383
●	32374	32384
●	32375	32385
○	32376	32386

Modulo ad alta luminosità a LED integrato, luce fissa. ELYPS LM S offre una manutenzione teoricamente nulla grazie alla tecnologia a LED che garantisce 100.000* ore d'utilizzo. Disponibile con lente allCOLOR e allCLEAR.

* In condizioni normali, in assenza di vibrazioni e sbalzi di temperatura

Tensione operativa

A seconda del modulo di cablaggio WM selezionato:
con WM LT e WM LT MULTI: 12V ACDC, 24V ACDC
con WM HT e WM HT MULTI: 120/240V AC

Caratteristiche meccaniche

Polycarbonato autoestinguente ad alta resistenza agli impatti, adatto per utilizzo esterno grazie al grado di protezione IP66, UL TYPE 4X, garantito dalla guarnizione di tenuta in silicone presente su ogni modulo.

Caratteristiche luminose

6x LED ad alta luminosità (3 per lato), luce fissa. Lente con rigatura verticale per una perfetta distribuzione della luce a 360°.

Disponibile con 2 tipi di lente: allCOLOR (lente colorata con fonte luminosa colorata) e allCLEAR (lente neutra con fonte luminosa colorata), vedi pagina 132.

Certificazioni / Certifications

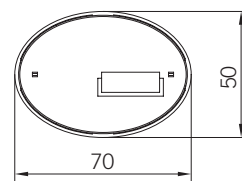
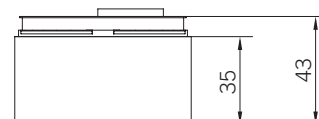

LM S



Integrated bright LED steady light module. ELYPS LM S offers virtually zero maintenance thanks to the built-in LED technology that guarantees up to 100.000* hours of product life.

Available with allCOLOR and allCLEAR lens.
* At normal conditions, without vibrations and heavy temperature changes

Voltagés

According to selected Wiring Module (WM) with WM LT and WM LT MULTI: 12V ACDC, 24V ACDC
with WM HT and WM HT MULTI: 120/240V AC

Mechanical features

Self-extinguishing PC body with high impact resistance, suitable for outdoor use thanks to the IP66, UL TYPE 4X protection grade, assured by the silicon gasket on each module.

Optical features

6x Bright LEDs (3 per side) producing steady light. The vertically lined lens allows a perfect light distribution over 360°.

Available with 2 different lens types, allCOLOR (colored lens with colored light source) and allCLEAR (clear lens with colored light source), see page 132.



Élément lumineux à LED intégrées, haute luminosité, à lumière fixe. ELYPS LM S offre un entretien quasi-nul grâce à la technologie intégrée du LED qui garantit jusqu'à 100.000* heures de vie au produit.

Disponible avec lentille allCOLOR et allCLEAR.

* Dans des conditions normales, sans vibrations et sans variations importantes de température

Tension d'utilisation

En fonction de l'élément de câblage WM choisi : avec WM LT et WM LT MULTI : 12V ACDC, 24V ACDC
avec WM HT et WM HT MULTI : 120/240V AC

Caractéristiques mécaniques

Polycarbonate autoextinguible, haute résistance aux chocs, adapté pour une utilisation à l'extérieur grâce au degré de protection IP66, UL TYPE 4X, garanti par un joint en silicone sur chaque élément.

Caractéristiques optiques

6x LED haute luminosité (3 pour chaque côté) à lumière fixe. La lentille striée en verticale permet une répartition parfaite de la lumière sur 360°. Disponible avec 2 différents types de lentilles : allCOLOR (lentille colorée et source lumineuse colorée) et allCLEAR (lentille incolore transparente avec source lumineuse colorée), voir page 132.

ELYPS LM S MULTI



ELYPS LM S MULTI

Cupole / Domes / Dômes

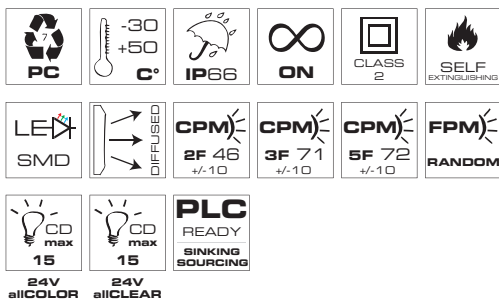

ELYPS LM S MULTI + ELYPS WM

V DC	12	-	24	-	-	-
V AC	-	12	-	24	120	240
mA	75	90	50	100	30	25

Codici / Codes

ELYPS LM S MULTI

	allCOLOR	allCLEAR
●	32391	32401
●	32392	32402
●	32393	32403
●	32394	32404
●	32395	32405
○	32396	32396

Modulo ad alta luminosità multifunzione (4 effetti luminosi) a LED integrato. ELYPS LM S MULTI offre una manutenzione teoricamente nulla grazie alla tecnologia a LED che garantisce 100.000* ore d'utilizzo.

Disponibile con lente allCOLOR e allCLEAR.

* In condizioni normali, in assenza di vibrazioni e sbalzi di temperatura

Tensione operativa

A seconda del modulo di cablaggio WM selezionato:

con WM LT: 12V ACDC, 24V ACDC

con WM HT: 120/240V AC

Caratteristiche meccaniche

Polycarbonato autoestinguente ad alta resistenza agli impatti, adatto per utilizzo esterno grazie al grado di protezione IP66, UL TYPE 4X, garantito dalla guarnizione di tenuta in silicone presente su ogni modulo.

Caratteristiche luminose

6x LED ad alta luminosità (3 per lato), 4 effetti luminosi selezionabili tramite dip-switch: doppio flash, triplo flash, stroboscopico e random (lampeggio casuale che aumenta la capacità di attirare l'attenzione dell'operatore).

Lente con rigatura verticale per una perfetta distribuzione della luce a 360°.

Disponibile con 2 tipi di lente: allCOLOR (lente colorata con fonte luminosa colorata) e allCLEAR (lente neutra con fonte luminosa colorata), vedi pagina 132.

Certificazioni / Certifications

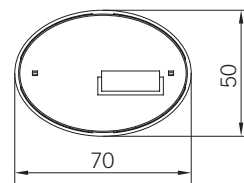
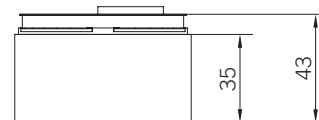

LM S MULTI



Integrated bright LED multifunctional light module (4 light effects). ELYPS LM S MULTI offers virtually zero maintenance thanks to the built-in LED technology that guarantees up to 100.000* hours of product life.

Available with allCOLOR and allCLEAR lens.

* At normal conditions, without vibrations and heavy temperature changes

Voltages

According to selected Wiring Module (WM)

with WM LT: 12V ACDC, 24V ACDC

with WM HT: 120/240V AC

Mechanical features

Self-extinguishing PC body with high impact resistance, suitable for outdoor use thanks to the IP66, UL TYPE 4X protection grade, assured by the silicon gasket on each module.

Optical features

6x Bright LEDs (3 per side) producing 4 light effects selectable via dip-switch: double flash, triple flash, stroboscopic and random (the random effect consists in an uneven flashing pattern, augmenting the ability of catching attention). The vertically lined lens allows a perfect light distribution over 360°.

Available with 2 different lens types, allCOLOR (colored lens with colored light source) and allCLEAR (clear lens with colored light source), see page 132.



Élément lumineux multifonction à LED intégrées à haute luminosité (4 effets lumineux). ELYPS LM S MULTI offre un entretien quasi-nul grâce à la technologie intégrée du LED qui garantit jusqu'à 100.000* heures de vie au produit.

Disponible avec lentille allCOLOR et allCLEAR.

* Dans des conditions normales, sans vibrations et sans variations importantes de température

Tension d'utilisation

En fonction de l'élément de câblage WM choisi :

avec WM LT : 12V ACDC, 24V ACDC

avec WM HT : 120/240V AC

Caractéristiques mécaniques

Polycarbonate autoextinguible, haute résistance aux chocs, adapté pour une utilisation à l'extérieur grâce au degré de protection IP66, UL TYPE 4X, garanti par un joint en silicone sur chaque élément.

Caractéristiques optiques

6x LED haute luminosité (3 pour chaque côté), 4 effets lumineux sélectionnables par dip-switch : double éclat, triple éclat, effet stroboscopique, effet random (un clignotement aléatoire qui permet au dispositif d'augmenter sa capacité d'attirer l'attention). La lentille striée en verticale permet une répartition parfaite de la lumière sur 360°.

Disponible avec 2 différents types de lentilles : allCOLOR (lentille colorée et source lumineuse colorée) et allCLEAR (lentille incolore transparente avec source lumineuse colorée), voir page 132.

ELYPS LM X MULTI



70 x 50 mm



ELYPS LM X MULTI

Cupole / Domes / Dômes



ELYPS LM X MULTI + ELYPS WM

V DC	12	-	24	-	-	-
V AC	-	12	-	24	120	240
mA	100	120	60	100	35	25

Codici / Codes

ELYPS LM X MULTI



Modulo superluminoso multifunzione (4 effetti luminosi) a LED integrato. **ELYPS LM X MULTI** è stato progettato per sostituire i moduli tradizionali con lampada a scarica di Xenon. Offre una manutenzione teoricamente nulla grazie alla tecnologia a LED che garantisce 100.000* ore d'utilizzo.

* In condizioni normali, in assenza di vibrazioni e sbalzi di temperatura

Tensione operativa

A seconda del modulo di cablaggio WM selezionato:
con **WM LT**: 12V ACDC, 24V ACDC
con **WM HT**: 120/240V AC

Caratteristiche meccaniche

Polycarbonato autoestinguente ad alta resistenza agli impatti, adatto per utilizzo esterno grazie al grado di protezione IP66, UL TYPE 4X, garantito dalla guarnizione di tenuta in silicone presente su ogni modulo.

Caratteristiche luminose

2x LED superluminosi (1 per lato), 4 effetti luminosi: doppio flash, triplo flash, stroboscopico e random (lampeggio casuale che aumenta la capacità di attirare l'attenzione dell'operatore). Lente **allCOLOR** con rigatura verticale per una perfetta distribuzione della luce a 360°.

Certificazioni / Certifications

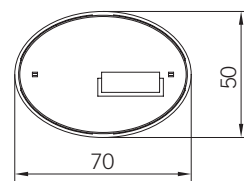
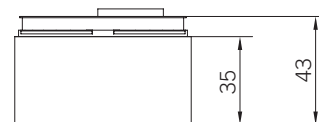

LM X MULTI



Integrated superbright LED multifunctional light module (4 light effects). Engineered to substitute traditional Xenon discharge lamps modules, **ELYPS LM X MULTI** offers virtually zero maintenance thanks to the built-in LED technology that guarantees up to 100.000* hours of product life.

* At normal conditions, without vibrations and heavy temperature changes

Voltages

According to selected Wiring Module (WM)
with **WM LT**: 12V ACDC, 24V ACDC
with **WM HT**: 120/240V AC

Mechanical features

Self-extinguishing PC body with high impact resistance, suitable for outdoor use thanks to the IP66, UL TYPE 4X protection grade, assured by the silicon gasket on each module.

Optical features

2x SuperBright LEDs (1 per side) producing 4 light effects: double flash, triple flash, stroboscopic and random (the random effect consists in an uneven flashing pattern, augmenting the ability of catching attention). The vertically lined lens **allCOLOR** allows a perfect light distribution over 360°.



Élément extra lumineux multifonction à LED intégrées (4 effets lumineux). Conçu pour remplacer les éléments avec ampoule à décharge au xénon traditionnels, **ELYPS LM X MULTI** offre un entretien quasi-nul grâce à la technologie intégrée du LED qui garantit jusqu'à 100.000* heures de vie au produit.

* Dans des conditions normales, sans vibrations et sans variations importantes de température

Tension d'utilisation

En fonction de l'élément de câblage WM choisi :
avec **WM LT** : 12V ACDC, 24V ACDC
avec **WM HT** : 120/240V AC

Caractéristiques mécaniques

Polycarbonate autoextinguible, haute résistance aux chocs, adapté pour une utilisation à l'extérieur grâce au degré de protection IP66, UL TYPE 4X, garanti par un joint en silicone sur chaque élément.

Caractéristiques optiques

2x LED extra lumineux (1 pour chaque côté), 4 effets lumineux : double éclat, triple éclat, effet stroboscopique, effet random (un clignotement aléatoire qui permet au dispositif d'augmenter sa capacité d'attirer l'attention). La lentille **allCOLOR** striée en verticale permet une répartition parfaite de la lumière sur 360°.

ELYPS AM



70 x 50 mm



ELYPS AM
ELYPS AM S

Corpo / Body / Corps



ELYPS AM + ELYPS WM

V DC	12	-	24	-	-	-
V AC	-	12	-	24	120	240
mA	20	40	50	120	30	25
dB(A)1m	70	77	87	87	87	87

ELYPS AM + ELYPS WM MULTI

V DC	12	-	24	-	-	-
V AC	-	12	-	24	120	240
mA	30	80	65	130	30	25
dB(A)1m	67	77	87	87	87	87

ELYPS AM S + ELYPS WM

V DC	12	-	24	-	-	-
V AC	-	12	-	24	120	240
mA	100	200	200	450	100	50
dB(A)1m	87	87	90	90	90	90

ELYPS AM S + WM MULTI

V DC	12	-	24	-	-	-
V AC	-	12	-	24	120	240
mA	150	390	200	450	100	50
dB(A)1m	87	87	90	90	90	90

Codici / Codes

ELYPS AM

ELYPS AM	32337	32338
ELYPS AM S	32347	32348

I moduli acustici ELYPS AM sono disponibili in 2 versioni, in base alle esigenze applicative:

ELYPS AM - Modulo acustico piezoelettrico con 2 tipologie di suono (continuo ed intermittente) disposte su 2 canali (1+1). È possibile utilizzare entrambi i canali utilizzando 2 dei 7 contatti disponibili sul modulo di cablaggio.

ELYPS AM S - Modulo acustico magnetodinamico con 16 suoni disposti su 2 canali (8+8). Per ciascun canale è possibile selezionare il suono desiderato tramite dip-switch. È possibile utilizzare entrambi i canali utilizzando 2 dei 7 contatti disponibili sul modulo di cablaggio. Per ogni canale è possibile selezionare il suono tramite dip-switch.

Tensione operativa

A seconda del modulo di cablaggio WM selezionato:
con **WM LT** e **WM LT MULTI**: 12V ACDC, 24V ACDC
con **WM HT** e **WM HT MULTI**: 120/240V AC

Caratteristiche meccaniche

Polycarbonato autoestinguente ad alta resistenza agli impatti, adatto per utilizzo esterno grazie al grado di protezione IP66, UL TYPE 4X, garantito dalla guarnizione di tenuta in silicone presente su ogni modulo.

Caratteristiche acustiche

ELYPS AM - Unità piezoelettrica, frequenza 3600Hz +/-100 che produce: 1 suono intermittente + 1 suono continuo su 2 canali.

ELYPS AM S - Unità magnetodinamica, con volume regolabile (Min. 60 dB – Max. 90 dB), frequenze miste 490-2800Hz (a seconda della tipologia di suono selezionato) che produce: 8+8 suoni (tipologie miste) su 2 canali.

Certificazioni / Certifications

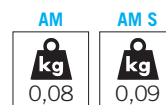
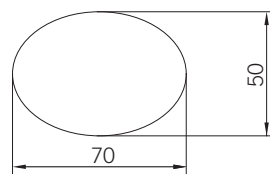
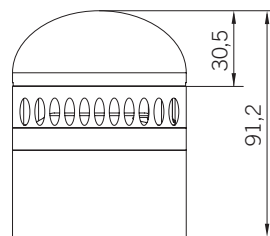

According to each application need, ELYPS AM acoustic modules are in two versions available:

ELYPS AM - Piezoelectric acoustic module with 2 sounds (continuous and intermittent) over 2 channels (1+1). It allows using both channels, by connecting 2 of the 7 available contacts of the wiring module.

ELYPS AM S - Magnetodynamic acoustic module with 16 sounds over 2 channels (8+8). It allows using both channels, by connecting 2 of the 7 available contacts of the wiring module. For each channel it is possible to select the sound via dip-switch.

Voltages

According to selected Wiring Module (WM) with **WM LT** and **WM LT MULTI**: 12V ACDC, 24V ACDC
with **WM HT** and **WM HT MULTI**: 120/240V AC

Mechanical features

Self-extinguishing PC body with high impact resistance, suitable for outdoor use thanks to the IP66, UL TYPE 4X protection grade, assured by the silicon gasket on each module.

Acoustic features

ELYPS AM - Piezoelectric unit, frequency 3600Hz +/-100 producing: 1+1 sounds (intermittent + continuous) over 2 channels.

ELYPS AM S - Magnetodynamic unit, with adjustable volume (Min. 60 dB – Max. 90 dB), mixed frequencies 490-2800Hz producing: 8+8 sounds (mixed types) over 2 channels.



Les éléments acoustiques ELYPS AM sont disponibles en 2 versions, en raison de chaque nécessité d'application :

ELYPS AM - Élément acoustique piézoélectrique avec 2 sons (continu ou intermittent) sélectionnables sur 2 canaux (1+1). Il permet d'utiliser les deux canaux, en reliant 2 des 7 contacts disponibles sur l'élément de câblage.

ELYPS AM S - Élément acoustique magnétodynamique avec 16 sons sur 2 canaux (8+8). Il permet d'utiliser les deux canaux, en reliant 2 des 7 contacts disponibles sur l'élément de câblage. Il est possible de sélectionner le son pour chaque canal par dip-switch.

Tension d'utilisation

En fonction de l'élément de câblage WM choisi :
avec **WM LT** et **WM LT MULTI** : 12V ACDC, 24V ACDC
avec **WM HT** et **WM HT MULTI** : 120/240V AC

Caractéristiques mécaniques

Polycarbonate autoextinguible, haute résistance aux chocs, adapté pour une utilisation à l'extérieur grâce au degré de protection IP66, UL TYPE 4X, garanti par un joint en silicone sur chaque élément.

Caractéristiques acoustiques

ELYPS AM - Élément piézoélectrique, fréquence 3600Hz +/-100 qui produit : 1 son intermittent + 1 son continu sur 2 canaux.

ELYPS AM S - Élément magnétodynamique, avec volume du son réglable (Min. 60 dB – Max. 90 dB), fréquence mixte 490-2800Hz (sur la base du son choisi) qui produit : 8+8 sons (tonalités mixtes) sur 2 canaux.

ELYPS MB



FLAT BASE

WALL BASE

POLE BASE
1/2" NPT-F

EXTENDED BASE

TUBE BASE

Nella foto:
BASE MB TUBE SS L400

In the picture:
MB BASE TUBE SS L400

Sur la photo:
BASE MB TUBE SS L400

Corpo / Body / Corps



Codici / Codes

ELYPS MB

	●	●
FLAT BASE	32357	32358
WALL BASE	32367	32368
POLE BASE	32387	32388
EXTENDED BASE	32377	32378

TUBE BASE:

SS L100	32420	32424
SS L200	32421	32425
SS L300	32422	32426
SS L400	32423	32427

Le basi ELYPS MB, necessarie per la configurazione della colonna, offrono la massima versatilità grazie alle molteplici soluzioni di fissaggio.

FLAT BASE - Sviluppata per il montaggio su superficie piana, quando il cablaggio avviene dalla parte inferiore del dispositivo o dove è richiesto un design compatto.

WALL BASE - Sviluppata per il fissaggio laterale/a parete.

POLE BASE - Sviluppata per l'installazione su palo filettato 1/2" NPT-F.

EXTENDED BASE - Sviluppata per il montaggio su superficie piana (colonna rialzata di 10 cm).

TUBE BASE - Sviluppata per il montaggio su superficie piana con prolunga in acciaio INOX. Lunghezze disponibili: 10, 20, 30 e 40 cm. Lunghezze personalizzate disponibili a richiesta.

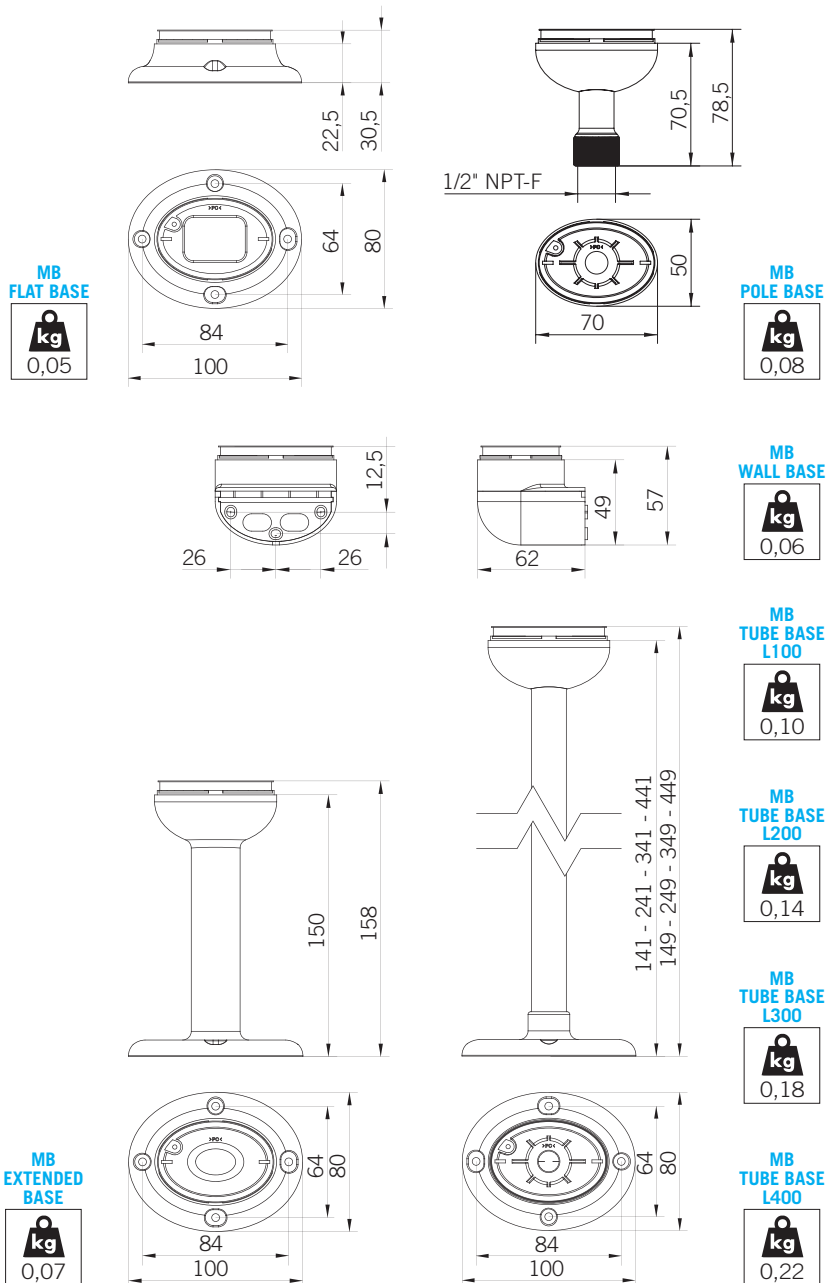

ELYPS MB mounting bases are necessary for stacklight configuration and offer versatility thanks to the different mounting solutions.

FLAT BASE - Designed for flat surface mounting when cabling occurs from the bottom of the device and where a compact design is required.

WALL BASE - Designed for lateral/wall mounting.

POLE BASE - Designed for installation on a 1/2" NPT-F threaded pole.

EXTENDED BASE - Designed mounting on flat surface. Stacklight position lifted by 10 cm.

TUBE BASE - Designed for flat surface mounting with stainless steel extension tube.

Tube lengths available: 10, 20, 30 and 40 cm. Custom lengths available on request.



Les bases ELYPS MB, nécessaires pour la configuration de la colonne, offrent une polyvalence grâce aux diverses solutions de montage.

FLAT BASE - Conçue pour le montage à plat lorsque le câblage est réalisé à partir du bas du dispositif et où un design compact est nécessaire.

WALL BASE - Conçue pour le montage sur surfaces latérales

POLE BASE - Conçue pour une installation sur un mât fileté 1/2" NPT-F.

EXTENDED BASE - Conçue pour le montage sur surfaces à plat (position soulevée de 10 cm).

TUBE BASE - Conçue pour le montage à plat avec un mât d'extension en acier inoxydable. Longueurs disponibles : 10, 20, 30 et 40 cm. Différentes longueurs disponibles sur demande.



GAMMA TWS INTRODUZIONE

Sirena, azienda specializzata nel campo della segnalazione acustica e luminosa, è da sempre sensibile al continuo rinnovamento produttivo che caratterizza il sistema industriale e per tale motivo ha ideato e realizzato la gamma **AUTOMAX** che comprende la linea di colonne luminose destinate alla segnalazione bordo macchina e industriale: la gamma **TWS**.

TWS è disponibile in tre misure idonee per le più diverse applicazioni:

- **TWS**: diametro di 70 mm
Moduli tradizionali, a LED, Xenon e acustici completati da una vasta gamma di accessori
- **miniTWS**: diametro di 50 mm
- **babyTWS**: diametro di 36 mm



TWS RANGE INTRODUCTION

Sirena, leader in the visual and acoustic signaling industry, is aware of the continuous manufacturing renovation process characterizing the industrial world.

For this reason, **AUTOMAX** has been developed, including the range of stacklights especially engineered for installation on machines and in industrial sites: **TWS** range.

TWS is available in three different sizes suitable for all types of industrial applications:

- **TWS**: 70 mm diameter
Traditional, integrated LED, Xenon and sounder modules completed with a wide range of accessories
- **minTWS**: 50 mm diameter
- **babyTWS**: 36 mm diameter



GAMME TWS INTRODUCTION

Sirena, société spécialisée dans le domaine de la signalisation lumineuse et acoustique, est depuis toujours sensible à l'évolution continue lors du développement des produits. Pour cette raison, Sirena a conçu et réalisé la gamme **AUTOMAX** ; une gamme qui comprend la ligne de colonnes lumineuses destinées à la signalisation pour l'installation sur machine ou pour la signalisation industrielle : la gamme modulaire **TWS**.

La gamme **TWS** est disponible en trois tailles différentes adaptées à tous les types d'applications:

- **TWS** : 70 mm diamètre
Éléments traditionnels, LED, Xénon et acoustiques complétés par une large gamme d'accessoires
- **miniTWS** : 50 mm de diamètre
- **babyTWS** : 36 mm de diamètre

TABELLA COMPARATIVA TWS TWS COMPARATIVE TABLE TABLEAU COMPARATIF TWS

70 mm



50 mm

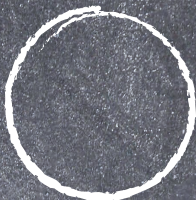

36 mm



TWS

miniTWS

babyTWS

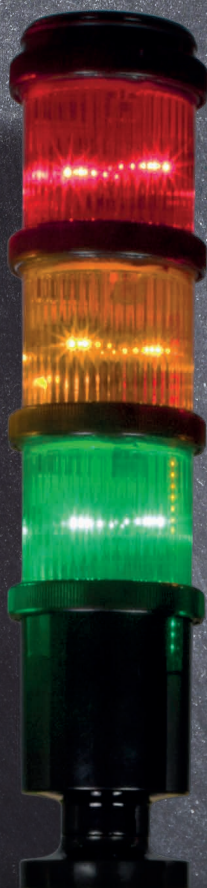

TWS CARATTERISTICHE

Le caratteristiche principali che contraddistinguono la linea **TWS** sono essenzialmente tre:

- SICUREZZA TOTALE, UNICA, ASSOLUTA

La colonna luminosa **TWS** offre una sicurezza elettrica senza precedenti. La speciale scheda di connessione viene inserita nella feritoia del modulo sottostante andando a creare il contatto elettrico in totale sicurezza. I moduli acustici e luminosi della colonna possono essere assemblati e rimossi sotto tensione.

- SEMPLICITÀ DI MONTAGGIO

Componibile in modo facile e veloce senza l'utilizzo di utensili. La ghiera di chiusura permette il bloccaggio totale dei moduli garantendo inoltre l'antisvitamento grazie alla speciale dentatura ad aggancio.

- VERSATILITÀ DI UTILIZZO TRAMITE UNA VASTA GAMMA DI ACCESSORI

La vasta gamma di accessori consente l'installazione della colonna in ogni condizione. Gli accessori sono dotati di filetto 1/2" NPT e possono essere montati sulla base **TWS** mantenendone le caratteristiche meccaniche.



TWS CHARACTERISTICS

The main characteristics that distinguish the **TWS** stacklights range are:

- UNIQUE ELECTRICAL SAFETY

TWS stacklight provides an unprecedented electrical safety concept. The special connection board is inserted in the slot of the connecting module creating an electrical contact in total safety. All modules can be assembled/disassembled without removing the power supply.

- EASY INSTALLATION

Quick and easy tool-less assembly. The locking ring allows modules to be tightly secured to each other and prevents accidental unscrewing thanks to the special connecting system.

- A WIDE RANGE OF ACCESSORIES FOR OPTIMAL VERSATILITY

The wide range of accessories allows multiple installation possibilities. The accessories are fitted with a 1/2" NPT thread and can be mounted on the **TWS** range maintaining all mechanical characteristics.



TWS CARACTERISTIQUES

Trois principales caractéristiques différencient la gamme des colonnes lumineuses **TWS** :

- SECURITE ELECTRIQUE ABSOLUE

Les colonnes lumineuses **TWS** offrent un concept de sécurité électrique sans précédents. La carte spécifique de connexion est insérée dans la fente de l'élément de connexion et crée un contact électrique en toute sécurité. Tous les éléments peuvent être assemblés ou désassemblés, tout en conservant l'appareil sous tension en toute sécurité.

- INSTALLATION FACILE

Montage sans outil rapide et facile. La bague de verrouillage permet aux éléments d'être solidement assemblés les uns aux autres et empêche le dévissage accidentel grâce au système d'encliquetage.

- UNE LARGE GAMME D'ACCESSOIRES POUR UNE POLYVALENCE OPTIMALE

La large gamme d'accessoires permet multiples possibilités d'installation de la colonne lumineuse. Les accessoires sont équipés d'un filetage 1/2" NPT et peuvent être montés sur la base du **TWS** conservant toutes les caractéristiques mécaniques.

MONTAGGIO MODULI MOUNTING COMBINATIONS COMBINAISONS DE MONTAGE



SUPERFICIE LATERALE (DOPPIA)
SIDE SURFACE (DOUBLE)
SUPPORT FIXATION EN APPLIQUE A DOUBLE FILETAGE

SUPERFICIE LATERALE (SINGOLA)
SIDE SURFACE (SINGLE)
SUPPORT FIXATION EN APPLIQUE A SIMPLE FILETAGE

STAFFA INOX CON PRESSACAUDO 1/2" NPT
STAINLESS STEEL BRACKET WITH 1/2" NPT CABLE GLAND
SUPPORT EN ACIER INOXYDABLE, FILETAGE 1/2" NPT

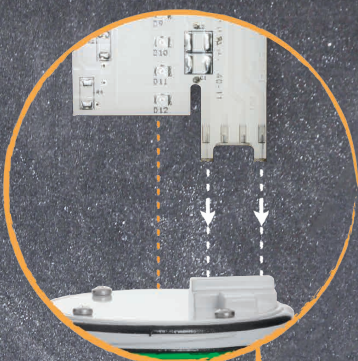

SICUREZZA ELETTRICA TOTALE
UNIQUE ELECTRICAL SAFETY
SECURITE ELECTRIQUE TOTALE



LA GHIERA DI FISSAGGIO CONSENTE UN'INSTALLAZIONE SEMPLICE E SENZA UTENSILI
THE FIXING RING ALLOWS A SIMPLE INSTALLATION WITHOUT TOOLS
INSTALLATION PAR SYSTEME A ENCASTREMENT, SIMPLE ET SANS OUTILS

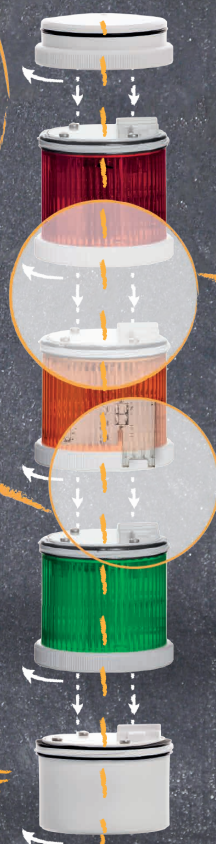

1/2" NPT - F

LA VASTA GAMMA DI ACCESSORI CONSENTE L'INSTALLAZIONE IN OGNI TIPO DI CONDIZIONE
THE WIDE ACCESSORIES RANGE ALLOWS INSTALLATION IN ANY CONDITION
LA LARGE GAMME D'ACCESSOIRES PERMET L'INSTALLATION EN TOUT TYPE DE CONDITION



SUPERFICIE PIANA (ESTESA 10 CM)
FLAT SURFACE (10 CM EXTENSION)
SURFACE PLANE (EXTENSION 10 CM)

SUPERFICIE PIANA (USO GRAVOSO)
FLAT SURFACE (STAINLESS STEEL)
SURFACE PLANE (ACIER INOXYDABLE)

SUPERFICIE PIANA CON PRESSACAUDO M16
FLAT SURFACE WITH M16 CABLE GLAND
SURFACE PLANE (AVEC PRESSE-ETOUPE M16)

SUPERFICIE PIANA
FLAT SURFACE
SURFACE PLANE

TWS BASE



TWS BASE

Corpo / Body / Corps



Base indispensabile per il cablaggio della colonna luminosa TWS. **TWS BASE** dispone di un contatto comune + 5 contatti indipendenti per consentire l'assemblaggio di un massimo di 5 moduli luminosi o 4 moduli luminosi + 1 modulo acustico.

Fornita con cappello per la chiusura superiore della colonna, nel caso non venga impiegato il modulo acustico.

Tensione operativa

Max. 240V

Caratteristiche meccaniche

Polycarbonato autoestinguente ad alta resistenza agli impatti, adatto per utilizzo esterno grazie al grado di protezione IP66, UL TYPE 4X, garantito dalla doppia guarnizione in poliuretano presente su ogni modulo. Filettatura 1/2" NPT-F sul fondo per consentire l'installazione della gamma di accessori TWS. Può essere installata direttamente (senza accessori) sul macchinario, forando la base nelle zone predisposte ed utilizzando la guarnizione fornita.

Certificazioni / Certifications

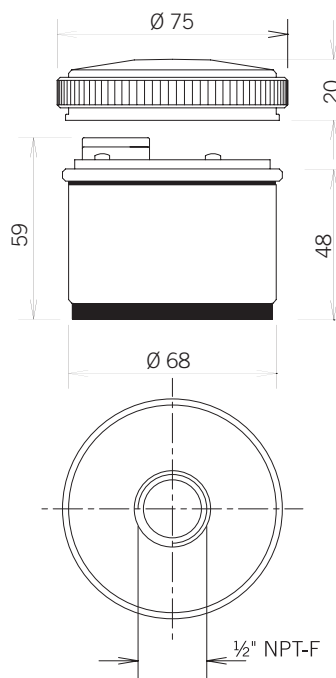

TWS BASE



Wiring base necessary for TWS stacklight installation. **TWS BASE** offers one common + 5 independent contacts and allows assembly of maximum 5 light modules or 4 light modules + 1 acoustic module. Provided with top cap to be used when the acoustic module is not installed.

Voltages

Max. 240V

Mechanical features

Self-extinguishing PC body with high impact resistance, suitable for outdoor applications thanks to the IP66, UL TYPE 4X protection grade guaranteed by a double polyurethane gasket on each module. A 1/2" NPT-F thread allows mounting of the complete accessory range. The base can also be installed directly (without accessories) on the machinery by drilling the marked pre-holes and using the provided gasket.



Base de câblage indispensable pour la configuration de la colonne TWS. **TWS BASE** prévoit une connexion commune + 5 connexions indépendant permettant le montage au maximum de 5 éléments lumineux ou 4 éléments lumineux + 1 élément acoustique. La base est fournie avec couvercles à utiliser lorsque l'élément acoustique n'est pas installé.

Tension d'utilisation

Max. 240V

Caractéristiques mécaniques

Polycarbonate autoextinguible, haute résistance aux chocs, adapté pour une utilisation à l'extérieur grâce au degré de protection IP66, UL TYPE 4X, garanti par un double joint en polyuréthane sur chaque élément. Le filetage 1/2" NPT-F permet le montage de la gamme complète d'accessoires. La base peut également être installée directement (sans accessoires) sur la machine en perçant les trous pré-marqué et en utilisant le joint fourni.

Codici / Codes

TWS BASE

Riferimenti pagina 158, paragrafo "BASE"
See page 158, section "BASE"
Voir page 158, section "BASE"

TWS LED



TWS LED

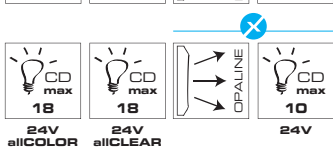
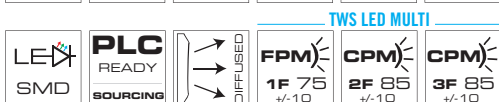

TWS LED STEADY

V DC	24	-	-	-
V AC	-	24	110	240
mA	65	85	35	35

TWS LED MULTI

V DC	24	-	-	-
V AC	-	24	110	240
Flash	-	1F 2F 3F	-	1F 2F 3F
mA	65	40 30 35	85 60 50	50 35 25

Codici / Codes

TWS LED

Riferimenti pagina 158, paragrafo "TWS LED"
See page 158, section "TWS LED"
Voir page 158, section "TWS LED"

Modulo luminoso a LED integrato. TWS LED offre una manutenzione teoricamente nulla grazie alla tecnologia a LED che garantisce 100.000* ore d'utilizzo. Disponibile in versione STEADY (luce fissa) o MULTI (luce fissa, singolo, doppio e triplo lampeggio) con lente allCOLOR, allCLEAR o PROXIMITY.
* In condizioni normali, in assenza di vibrazioni e sbalzi di temperatura

Tensione operativa

24V ACDC, 110V AC, 240V AC +/-10%

Caratteristiche meccaniche

Polycarbonato autoestinguente ad alta resistenza agli impatti, adatto per utilizzo esterno grazie al grado di protezione IP66, UL TYPE 4X, garantito dalla doppia guarnizione in poliuretano presente su ogni modulo.

Caratteristiche luminose

Lente con rigatura verticale per una perfetta distribuzione della luce a 360°.

TWS LED STEADY: luce fissa

TWS LED MULTI: luce fissa, singolo lampeggio 1F, doppio lampeggio 2F, triplo lampeggio 3F selezionabili tramite dip-switch.

Disponibili con 3 tipi di lente: allCOLOR (lente colorata con fonte luminosa colorata), allCLEAR (lente neutra con fonte luminosa colorata) e PROXIMITY (lente colorata opalina con fonte luminosa colorata), vedi pagina 132.

Certificazioni / Certifications

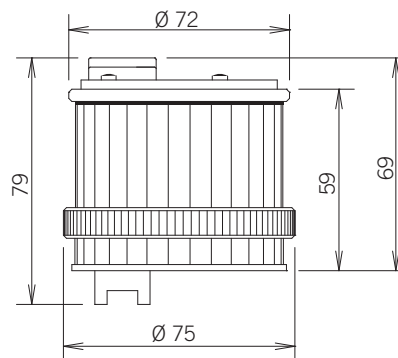

TWS LED



Integrated LED light module. TWS LED offers virtually zero maintenance thanks to the built-in LED technology that guarantees up to 100.000* hours of product life. Available in STEADY (steady light) and MULTI (steady light, single, double and triple flash) version, with allCOLOR, allCLEAR and PROXIMITY lens.
* At normal conditions, without vibrations and heavy temperature changes

Voltages

24V ACDC, 110V AC, 240V AC +/-10%

Mechanical features

Self-extinguishing PC body with high impact resistance, suitable for outdoor use thanks to the IP66, UL TYPE 4X protection grade, guaranteed by a double polyurethane gasket on each module.

Optical features

The vertically lined lens allows a perfect light distribution over 360°. TWS LED STEADY: steady light TWS LED MULTI: steady light, 1F single, 2F double and 3F triple flash selectable via dip-switch. Available with 3 different lens types, allCOLOR (colored lens with colored light source), allCLEAR (clear lens with colored light source) and PROXIMITY (opaline colored lens with colored light source), see page 132.



Élément lumineux à LED intégrée. TWS LED offre un entretien quasi-nul grâce à la technologie intégrée du LED qui garantit jusqu'à 100.000* heures de vie au produit. Disponible en version STEADY (lumière fixe) et MULTI (lumière fixe, simple, double ou triple éclat) avec lentille allCOLOR, allCLEAR ou PROXIMITY.
* Dans des conditions normales, sans vibrations et sans variations importantes de température

Tension d'utilisation

24V ACDC, 110V AC, 240V AC +/-10%

Caractéristiques mécaniques

Polycarbonate autoextinguible, haute résistance aux chocs, adapté pour une utilisation à l'extérieur grâce au degré de protection IP66, UL TYPE 4X, garanti par un double joint en polyuréthane sur chaque élément.

Caractéristiques optiques

La lentille striée en verticale permet une répartition parfaite de la lumière sur 360°. TWS LED STEADY : lumière fixe TWS LED MULTI : lumière fixe, simple éclat 1F, double éclat 2F ou triple éclat 3F sélectionnables par dip-switch. Disponible avec 3 différents types de lentilles : allCOLOR (lentille colorée et source lumineuse colorée), allCLEAR (lentille incolore transparente avec source lumineuse colorée) et PROXIMITY (lentille opaline colorée avec source lumineuse colorée), voir page 132.

TWS S



70 mm



Modulo / Module / Élément

Ghiera / Ring / Bague

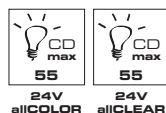

TWS S

V ACDC	12 ÷ 24
mA	450 420

Modulo superluminoso multifunzione a LED integrato. TWS S offre una manutenzione teoricamente nulla grazie alla tecnologia a LED che garantisce 100.000* ore d'utilizzo. Dispone di 4 effetti luminosi: luce fissa, lampeggiante, stroboscopica e random. Disponibile con lente **allCOLOR** e **allCLEAR**.

* In condizioni normali, in assenza di vibrazioni e sbalzi di temperatura

Tensione operativa

12/24V ACDC +/-10%

Caratteristiche meccaniche

Polycarbonato autoestinguente ad alta resistenza agli impatti, adatto per utilizzo esterno grazie al grado di protezione IP66, UL TYPE 4X, garantito dalla doppia guarnizione in poliuretano presente su ogni modulo.

Caratteristiche luminose

Lente con rigatura verticale per una perfetta distribuzione della luce a 360°.

4 effetti luminosi selezionabili tramite dip-switch: luce fissa, lampeggiante 1F, stroboscopica 3F e random (effetto unico nel suo genere con lampeggio casuale che consente di aumentare la capacità del dispositivo di attirare l'attenzione).

Disponibile con 2 tipi di lente: **allCOLOR** (lente colorata con fonte luminosa colorata) e **allCLEAR** (lente neutra con fonte luminosa colorata), vedi pagina 132.

Certificazioni / Certifications

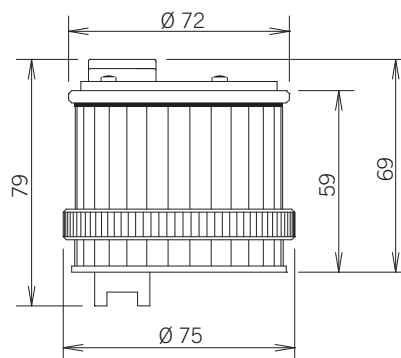

TWS S



Superbright multifunctional integrated LED light module. TWS S offers virtually zero maintenance thanks to the built-in LED technology that guarantees up to 100.000* hours of product life. Enriched by 4 light effects: steady, flashing, strobe and random. Available with **allCOLOR** and **allCLEAR** lens.

* At normal conditions, without vibrations and heavy temperature changes

Voltages

12/24V ACDC +/-10%

Mechanical features

Self-extinguishing PC body with high impact resistance, suitable for outdoor use thanks to the IP66, UL TYPE 4X protection grade, guaranteed by a double polyurethane gasket on each module.

Optical features

The vertically lined lens allows a perfect light distribution over 360°.

4 light effects selectable via dip-switch: steady, 1F flashing, 3F strobe and random (a unique random effect consisting in an uneven flashing pattern, augmenting the ability of catching attention). Available with 2 different lens types, **allCOLOR** (colored lens with colored light source) and **allCLEAR** (clear lens with colored light source), see page 132.



Élément lumineux à LED intégrée, extra lumineux. TWS S offre un entretien quasi-nul grâce à la technologie intégrée du LED qui garantit jusqu'à 100.000* heures de vie au produit.

Il permet 4 effets lumineux : lumière fixe, clignotante, stroboscopique et random. Le produit est disponible avec lentille **allCOLOR** ou **allCLEAR**.

* Dans des conditions normales, sans vibrations et sans variations importantes de température

Tension d'utilisation

12/24V ACDC +/-10%

Caractéristiques mécaniques

Polycarbonate autoextinguible, haute résistance aux chocs, adapté pour une utilisation à l'extérieur grâce au degré de protection IP66, UL TYPE 4X, garanti par un double joint en polyuréthane sur chaque élément.

Caractéristiques optiques

La lentille striée en verticale permet une répartition parfaite de la lumière sur 360°.

4 effets lumineux sélectionnables par dip-switch : lumière fixe, clignotante, effet stroboscopique et random (consistant en un clignotement aléatoire, qui permet au dispositif d'augmenter la capacité d'attirer l'attention).

Disponible avec 2 différents types de lentilles : **allCOLOR** (lentille colorée et source lumineuse colorée) ou **allCLEAR** (lentille incolore transparente avec source lumineuse colorée), voir page 132.

Codici / Codes

TWS S

Riferimenti pagina 158, paragrafo "TWS S"
See page 158, section "TWS S"
Voir page 158, section "TWS S"

TWS RGA



TWS RGA

Modulo / Module / Élément



Ghiera / Ring / Bague

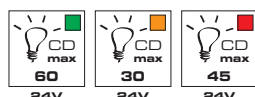

TWS RGA

V ACDC	12 ÷ 24
mA	430 420

Codici / Codes

TWS RGA

Riferimenti pagina 158, paragrafo "TWS RGA"
See page 158, section "TWS RGA"
Voir page 158, section "TWS RGA"

Modulo superluminoso multicolore a LED integrato. TWS RGA dispone di tre colori differenti (rosso, verde e ambra) e due effetti luminosi (luce fissa, lampeggiante) con un unico dispositivo. Offre una manutenzione teoricamente nulla grazie alla tecnologia a LED che garantisce 100.000* ore d'utilizzo. Disponibile con lente **allCLEAR**.

* In condizioni normali, in assenza di vibrazioni e sbalzi di temperatura

Tensione operativa

12/24V ACDC +/-10%

Caratteristiche meccaniche

Polycarbonato autoestinguente ad alta resistenza agli impatti, adatto per utilizzo esterno grazie al grado di protezione IP66, UL TYPE 4X, garantito dalla doppia guarnizione in poliuretano presente su ogni modulo.

Caratteristiche luminose

Lente con rigatura verticale per una perfetta distribuzione della luce a 360°, tipo **allCLEAR** (lente neutra con fonte luminosa colorata), vedi pagina 132.

3 colori differenti (rosso, verde e ambra) su altrettanti canali. Ogni canale dispone di due effetti luminosi selezionabili tramite dip-switch: luce fissa e lampeggiante 1F.

Certificazioni / Certifications

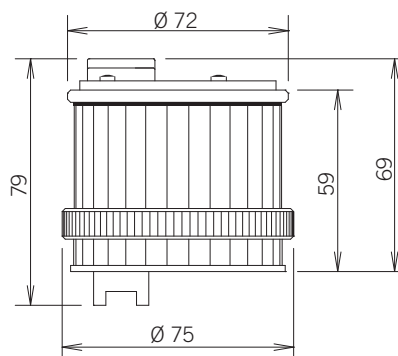

TWS RGA



Superbright multicolor integrated LED light module. TWS RGA allows three different colors (red, green, amber) and two light effects (steady, flashing light) on the same module. It offers virtually zero maintenance thanks to the built-in LED technology that guarantees up to 100.000* hours of product life. Available with **allCLEAR** lens.

* At normal conditions, without vibrations and heavy temperature changes

Voltages

12/24V ACDC +/-10%

Mechanical features

Self-extinguishing PC body with high impact resistance, suitable for outdoor use thanks to the IP66, UL TYPE 4X protection grade, guaranteed by a double polyurethane gasket on each module.

Optical features

The vertically lined lens allows a perfect light distribution over 360°, type **allCLEAR** (clear lens with colored light source), see page 132. 3 different colors (red, green and amber) controllable via independent channels. Each channel can be set to steady or 1F flashing mode via dip-switch.



Élément lumineux à LED intégrée, extra lumineux. TWS RGA permet d'avoir trois couleurs différentes (rouge, vert et orange) et deux effets lumineux (lumière fixe et clignotante) à partir d'un seul élément. Il offre un entretien quasi-nul grâce à la technologie intégrée du LED qui garantit jusqu'à 100.000* heures de vie au produit. Le produit est disponible avec lentille **allCLEAR**.

* Dans des conditions normales, sans vibrations et sans variations importantes de température

Tension d'utilisation

12/24V ACDC +/-10%

Caractéristiques mécaniques

Polycarbonate autoextinguible, haute résistance aux chocs, adapté pour une utilisation à l'extérieur grâce au degré de protection IP66, UL TYPE 4X, garanti par un double joint en polyuréthane sur chaque élément.

Caractéristiques optiques

La lentille striée en verticale permet une répartition parfaite de la lumière sur 360°, type **allCLEAR** (lentille incolore transparente avec source lumineuse colorée), voir page 132. 3 couleurs différentes (rouge, vert et orange). En plus, chaque canal peut être réglé en fonction fixe ou clignotante 1F par dip-switch.

TWS STEADY/ FLASHING



TWS STEADY
TWS FLASHING

Modulo / Module / Élément



Ghiera / Ring / Bague

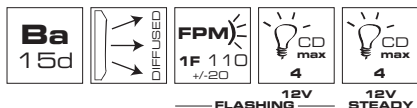

TWS STEADY

V ACDC	12 ÷ 24 ÷ 48 ÷ 110 ÷ 240
mA	430 210 100 35 22

TWS FLASHING

V DC	12 ÷ 24 ÷ 48	-	-
V AC	-	24 ÷ 48 ÷ 110 ÷ 240	
mA	420 210 103 37 27		

Modulo con portalamпада tradizionale di tipo Ba15d. **TWS STEADY/FLASHING** permette l'utilizzo delle tradizionali lampadine ad incandescenza da 5W o di lampade a LED a basso consumo.

Disponibile in versione **STEADY** (luce fissa) o **FLASHING** (luce lampeggiante).

Tensione operativa

TWS STEADY 12/240V ACDC +/-10%

TWS FLASHING 12/48V DC, 24/240V AC +/-10%

Caratteristiche meccaniche

Polycarbonato autoestinguente ad alta resistenza agli impatti, adatto per utilizzo esterno grazie al grado di protezione IP66, UL TYPE 4X, garantito dalla doppia guarnizione in poliuretano presente su ogni modulo.

Caratteristiche luminose

Lente con rigatura verticale per una perfetta distribuzione della luce a 360°.

TWS STEADY: luce fissa

TWS FLASHING: luce lampeggiante

Certificazioni / Certifications

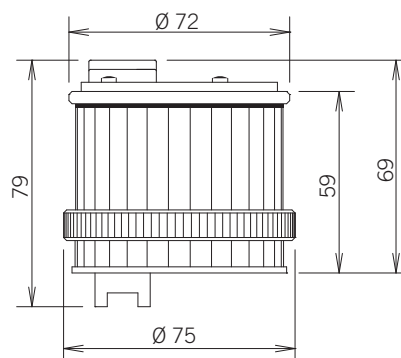

TWS STEADY
TWS FLASHING



Light module with traditional Ba15d lamp holder. **TWS STEADY/FLASHING** allows the use of traditional 5W incandescent bulbs as well as low consumption LED bulbs.

Available in **STEADY** (steady light) and **FLASHING** (flashing light) version.

Voltages

TWS STEADY 12/240V ACDC +/-10%

TWS FLASHING 12/48V DC, 24/240V AC +/-10%

Mechanical features

Self-extinguishing PC body with high impact resistance, suitable for outdoor use thanks to the IP66, UL TYPE 4X protection grade, guaranteed by a double polyurethane gasket on each module.

Optical features

The vertically lined lens allows a perfect light distribution over 360°.

TWS STEADY: steady light

TWS FLASHING: flashing light



Élément lumineux avec douille traditionnelle pour ampoules BA15d. **TWS STEADY/FLASHING** permet l'utilisation des ampoules traditionnelles à incandescence 5W ainsi que la faible consommation énergétique du LED.

Disponible en version **STEADY** (lumière fixe) et **FLASHING** (lumière clignotante).

Tension d'utilisation

TWS STEADY 12/240V ACDC +/-10%

TWS FLASHING 12/48V DC, 24/240V AC +/-10%

Caractéristiques mécaniques

Polycarbonate autoextinguible, haute résistance aux chocs, adapté pour une utilisation à l'extérieur grâce au degré de protection IP66, UL TYPE 4X, garanti par un double joint en polyuréthane sur chaque élément.

Caractéristiques optiques

La lentille striée en verticale permet une répartition parfaite de la lumière sur 360°.

TWS STEADY: lumière fixe

TWS FLASHING: lumière clignotante

Codici / Codes

TWS STEADY/FLASHING

Riferimenti pagina 158, paragrafo "TWS STEADY/FLASHING"
See page 158, section "TWS STEADY/FLASHING"
Voir page 158, section "TWS STEADY/FLASHING"

TWS X



TWS X

Modulo / Module / Élément



Ghiera / Ring / Bague

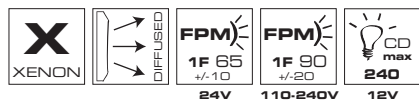

TWS X

V ACDC	24	-	-
V AC	-	110	240
mA	280	48	55

Modulo con lampada a scarica di Xenon integrata. TWS X grazie al potente flash da 2J è ideale per richiamare l'attenzione nelle applicazioni a più alto rischio.

Tensione operativa

24V ACDC, 110V AC, 240V AC +/-10%

Caratteristiche meccaniche

Polycarbonato autoestinguente ad alta resistenza agli impatti, adatto per utilizzo esterno grazie al grado di protezione IP66, UL TYPE 4X, garantito dalla doppia guarnizione in poliuretano presente su ogni modulo.

Caratteristiche luminose

Lente con rigatura verticale per una perfetta distribuzione della luce a 360° (effetto flash 2J).

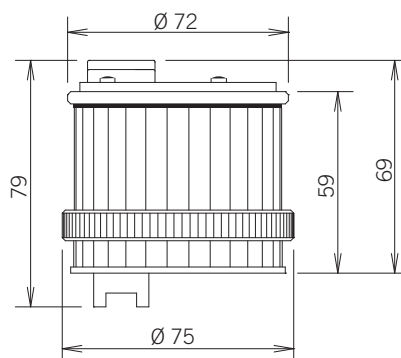
Certificazioni / Certifications

TWS X



Light module with integrated Xenon discharge lamp. TWS X, with the powerful 2J flash, is ideal for attracting attention in the most critical situations.

Voltages

24V ACDC, 110V AC, 240V AC +/-10%

Mechanical features

Self-extinguishing PC body with high impact resistance, suitable for outdoor use thanks to the IP66, UL TYPE 4X protection grade, guaranteed by a double polyurethane gasket on each module.

Optical features

The vertically lined lens allows a perfect light distribution over 360° (flashing effect 2J).



Élément lumineux avec lampe à décharge au Xénon intégrée. TWS X, grâce au puissant flash 2J, est idéal pour attirer l'attention dans les situations les plus critiques.

Tension d'utilisation

24V ACDC, 110V AC, 240V AC +/-10%

Caractéristiques mécaniques

Polycarbonate autoextinguible, haute résistance aux chocs, adapté pour une utilisation à l'extérieur grâce au degré de protection IP66, UL TYPE 4X, garanti par un double joint en polyuréthane sur chaque élément.

Caractéristiques optiques

La lentille striée en verticale permet une répartition parfaite de la lumière sur 360° (effet flash 2J).

Codici / Codes

TWS X

Riferimenti pagina 159, paragrafo "TWS X"
See page 159, section "TWS X"
Voir page 159, section "TWS X"

TWS

ACUSTICHE/SOUNDERS/ACOUSTIQUES



TWS PZO
TWS MDA

TWS A+ IP 65

Modulo / Module / Élément

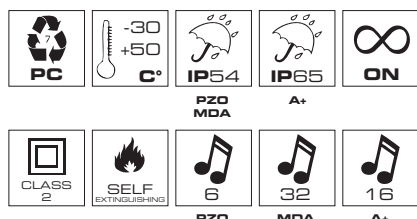

TWS PZO

V ACDC	12	24	48	-	-
V AC	-	-	-	110	240
mA	3	6	13	4	10
dB(A)1m	62÷72	69÷76	71÷81	68÷78	71÷81

TWS MDA

V DC	12	-	24	-	-	-	-
V AC	-	12	-	24	48	110	240
mA	30÷335	-	45÷450	-	72÷170	40÷105	25÷60
A	-	0,12÷0,95	-	0,17÷1,06	-	-	-
dB(A)1m	86 ÷ 103		91 ÷ 107		93 ÷ 103		

TWS A+

V DC	12	-	24	-	-	-
V AC	-	12	-	24	110	240
mA	70	230	70	240	30	15
dB(A)1m	78 ÷ 95		86 ÷ 95		80 ÷ 93	

Codici / Codes

TWS ACUSTICHE / SOUNDERS / ACOUSTIQUES

Riferimenti pagina 159, paragrafo "ACUSTICHE"
See page 159, section "SOUNDERS"
Voir page 159, section "ACOUSTIQUES"

I moduli acustici TWS sono disponibili in 3 versioni, in base alle esigenze applicative:
TWS PZO - Modulo acustico piezoelettrico. Dispone di 6 suoni selezionabili tramite dip-switch.

TWS MDA - Modulo acustico magnetodinamico ad alta potenza. Dispone di 32 suoni selezionabili tramite dip-switch.

TWS A+ - Modulo acustico magnetodinamico ad alto grado di protezione, IP65 idoneo all'utilizzo in ambienti esterni. Dispone di 16 suoni selezionabili tramite dip-switch.

Tensione operativa

TWS PZO: 12/48V ACDC, 110/240V AC +/-10%

TWS MDA: 12/24V ACDC, 48V AC, 110V AC, 240V AC +/-10%

TWS A+: 12/24V ACDC, 110/240V AC +/-10%

Caratteristiche meccaniche

Polycarbonato autoestinguente ad alta resistenza agli impatti, adatto per utilizzo esterno grazie al grado di protezione IP54, UL TYPE 3R (TWS A+: IP65, UL TYPE 3R), garantito dalla doppia guarnizione in poliuretano presente su ogni modulo.

Caratteristiche acustiche

TWS PZO - Unità piezoelettrica, frequenza 2800Hz +/-100 che produce: 3 suoni bassa potenza + 3 suoni alta potenza.

TWS MDA - Unità magnetodinamica, frequenze miste 300-2850Hz che produce 32 suoni (tipologie miste).

TWS A+ - Unità magnetodinamica, frequenze miste 300-2850Hz che produce 16 suoni (tipologie miste).

Certificazioni / Certifications

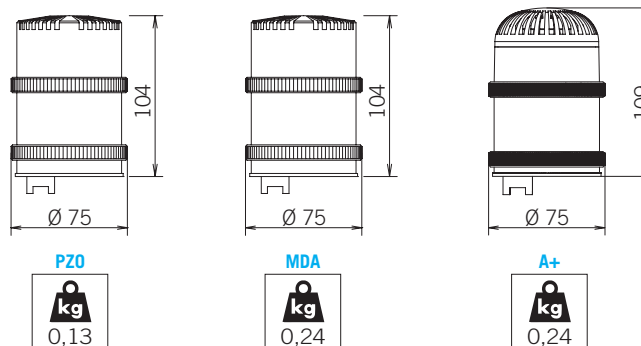

3 possible solutions of TWS sounder modules are available, according to each application need:
TWS PZO - Piezoelectric acoustic module. 6 tones selectable via dip-switch.

TWS MDA - High output magnetodynamic sounder. 32 tones selectable via dip-switch.

TWS A+ - High protection grade magnetodynamic sounder, IP65 ideal for outdoor applications. 16 tones selectable via dip-switch.

Voltages

TWS PZO: 12/48V ACDC, 110/240V AC +/-10%

TWS MDA: 12/24V ACDC, 48V AC, 110V AC, 240V AC +/-10%

TWS A+: 12/24V ACDC, 110/240V AC +/-10%

Mechanical features

Self-extinguishing PC body with high impact resistance, suitable for outdoor use thanks to the IP54 UL TYPE 3R protection grade (TWS A+: IP65, UL TYPE 3R), guaranteed by a double polyurethane gasket on each module.

Acoustic features

TWS PZO - Piezoelectric unit, frequency 2800Hz +/-100 producing: 3 (low output) + 3 (high output) tones.

TWS MDA - Magnetodynamic unit, mixed frequencies 300-2850Hz producing: 32 tones (mixed types).

TWS A+ - Magnetodynamic unit, mixed frequencies 300-2850Hz producing: 16 tones (mixed types).



Les éléments acoustiques TWS sont disponibles en 3 versions, en raison de chaque nécessité d'application :

TWS PZO - Élément acoustique piézoélectrique. 6 tonalités sélectionnables par dip-switch.

TWS MDA - Élément acoustique magnétodynamique à haut rendu acoustique. 32 tonalités sélectionnables par dip-switch.

TWS A+ - Élément acoustique magnétodynamique à haut degré de protection IP65, est l'idéal pour les applications à l'extérieur. 16 tonalités sélectionnables par dip-switch.

Tension d'utilisation

TWS PZO: 12/48V ACDC, 110/240V AC +/-10%

TWS MDA: 12/24V ACDC, 48V AC, 110V AC, 240V AC +/-10%

TWS A+: 12/24V ACDC, 110/240V AC +/-10%

Caractéristiques mécaniques

Polycarbonate autoextinguible, haute résistance aux chocs, adapté pour une utilisation à l'extérieur grâce au degré de protection IP54 UL TYPE 3R (TWS A+: IP65, UL TYPE 3R), garanti par un joint en silicone sur chaque élément.

Caractéristiques acoustiques

TWS PZO - Élément piézoélectrique, fréquence 2800Hz +/-100 qui produit : 3 tonalités (faible puissance acoustique) + 3 tonalités (haute puissance acoustique).

TWS MDA - Élément magnétodynamique, fréquences mixtes 300-2850Hz qui produit 32 tonalités (tonalités mixtes).

TWS A+ - Élément magnétodynamique, fréquences mixtes 300-2850Hz qui produit 16 tonalités (tonalités mixtes).

TWS HD



Esempio con colonna 3 moduli
TWS S **allCLEAR** e base piana

Assembly example with 3
TWS S **allCLEAR** modules
and flat mounter

Exemple de montage avec 3
éléments TWS S **allCLEAR** et
base plate



TWS HD SS



TWS HD AL



Esempio con colonna 3 moduli
TWS LED **PROXIMITY** e base
piana

Assembly example with 3
TWS LED **PROXIMITY** modules
and flat mounter

Exemple de montage avec 3
éléments TWS LED **PROXIMITY**
et base plate

TWS HD SS

Custodia in acciaio inossidabile con grado di protezione IP69K sviluppata per la gamma TWS.

TWS HD AL

Custodia in alluminio anodizzato Heavy Duty con grado di protezione IP69K sviluppata per l'utilizzo gravoso della gamma TWS.

Il grado IP69K (il più alto grado di protezione disponibile) fornisce protezione contro l'ingresso di polveri e acqua in condizioni di alta temperatura e pressione, rendendo ideale l'utilizzo di queste custodie in condizioni in cui le apparecchiature devono essere accuratamente igienizzate.

In settori come quello alimentare, dove igiene e pulizia sono fondamentali, i macchinari devono essere in grado di resistere a procedure di lavaggio ad alta pressione e temperatura (wash-down).

Le custodie **TWS HD** IP69K devono essere installate tramite una delle basi da ordinare separatamente:

- BASE PIANA: su superficie piana
- BASE PALO: su tubo filettato
- BASE LATERALE: per installazione a parete

Caratteristiche meccaniche

TWS HD SS: Corpo in acciaio INOX AISI 316 lucidato. Tubo in PC trattato per la resistenza ai raggi UV. La valvola Gore-tex® applicata sulla base del dispositivo consente di evitare la formazione di condensa.

TWS HD AL: Corpo in alluminio anodizzato nero. Tubo in PC trattato per la resistenza ai raggi UV. La valvola Gore-tex® applicata sulla base del dispositivo consente di evitare la formazione di condensa.

Certificazioni / Certifications

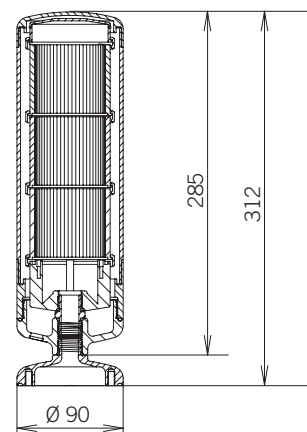

TWS HD SS

IP69K stainless steel enclosure engineered for the TWS range.

TWS HD AL

IP69K Heavy Duty anodized aluminum enclosure engineered for the TWS range.

IP69K grade (the highest protection grade available) protects stacklight from high temperature and pressure dust/water, making these products ideal in all situations where machineries need to be accurately sanitized. Particularly in the food industry, where hygiene is a must, machinery needs to be able to withstand wash-down (high pressure/high temperature washing) procedures.

IP69K **TWS HD** enclosures must be installed using one of the following mounters (sold separately):

- FLAT MOUNTER: on flat surfaces
- POLE MOUNTER: on a threaded pole
- SIDE MOUNTER: on lateral (wall) surfaces

Mechanical features

TWS HD SS: Polished stainless steel (AISI 316) body. UV resistant polycarbonate tube. A Gore-tex® valve installed at the bottom of the enclosure allows a condense-free environment.

TWS HD AL: Black anodized aluminum body. UV resistant polycarbonate tube. A Gore-tex® valve installed at the bottom of the enclosure allows a condense-free environment.



TWS HD SS

Boîtier en acier inoxydable, degré de protection IP69K conçu pour la gamme TWS.

TWS HD AL

Boîtier en aluminium anodisé Heavy Duty (usage intensif), degré de protection IP69K conçu pour la gamme TWS.

Le degré de protection IP69K des boîtiers (le plus haut degré disponible) protège la colonne lumineuse contre les températures élevées et la poussière/eau sous pression, ce qui en fait le produit idéal dans toutes les situations où les dispositifs doivent être désinfectés avec précision. En particulier dans l'industrie alimentaire, où l'hygiène est un impératif, les dispositifs doivent être capable de résister aux lavages à haute pression et/ou haute température.

Les boîtiers **TWS HD** IP69K doivent être installés en utilisant un des supports (vendus séparément) :

- BASE PLATE : sur des surfaces plates
- BASE TUBE : sur support fileté
- SUPPORT LATERAL : sur des surfaces latérales (paroi)

Caractéristiques mécaniques

TWS HD SS : Corps en acier inoxydable INOX AISI 316. Tube en polycarbonate résistant aux UV, la soupape en Gore-tex® appliquée sur la base de l'appareil permet d'éviter la formation de la condensation.

TWS HD AL : Corps en aluminium anodisé noir. Tube en polycarbonate résistant aux UV, la soupape en Gore-tex® appliquée sur la base de l'appareil permet d'éviter la formation de la condensation.

Codici / Codes

TWS HD

Riferimenti pagina 159, paragrafo "TWS HD"
See page 159, section "TWS HD"
Voir page 159, section "TWS HD"

Codici / Codes

BASE / BASE / BASE



TWS LED

Modulo a LED integrato / Integrated LED light module / Élément lumineux à LED intégrée

STEADY (luce fissa / steady light / lumière fixe)

allCOLOR	24V ACDC 36471 36681	36472 36682	36473 36683	36474 36684	36475 36685	36476 36686
	110V AC 36481 36691	36482 36692	36483 36693	36484 36694	36485 36695	36486 36696
	240V AC 36491 36701	36492 36702	36493 36703	36494 36704	36495 36705	36496 36706
allCLEAR	24V ACDC 33121 33151	33122 33152	33123 33153	33124 33154	33122 33152	36476 36686
	110V AC 33131 33161	33132 33162	33133 33163	33134 33164	33132 33162	36486 36696
	240V AC 33141 33171	33142 33172	33143 33173	33144 33174	33142 33172	36496 36706
proXimity	24V ACDC 32201 32231	32202 32232	32203 32233	32204 32234	32205 32235	32206 32236
	110V AC 32211 32241	32212 32242	32213 32243	32214 32244	32215 32245	32216 32246
	240V AC 32221 32251	32222 32252	32223 32253	32224 32254	32225 32255	32226 32256

MULTI (luce fissa, lampeggio singolo, doppio o triplo / steady light, single, double or triple flash / lumière fixe, flash simple, double ou triple éclat)

allCOLOR	24V ACDC 36501 36711	36502 36712	36503 36713	36504 36714	36505 36715	36506 36716
	110V AC 36511 36721	36512 36722	36513 36723	36514 36724	36515 36725	36516 36726
	240V AC 36521 36731	36522 36732	36523 36733	36524 36734	36525 36735	36526 36736
allCLEAR	24V ACDC 33181 33211	33182 33212	33183 33213	33184 33214	33182 33212	36506 36716
	110V AC 33191 33221	33192 33222	33193 33223	33194 33224	33192 33222	36516 36726
	240V AC 33201 33231	33202 33232	33203 33233	33204 33234	33202 33232	36526 36736
proXimity	24V ACDC 32261 32291	32262 32292	32263 32293	32264 32294	32265 32295	32266 32296
	110V AC 32271 32301	32272 32302	32273 32303	32274 32304	32275 32305	32276 32306
	240V AC 32281 32311	32282 32312	32283 32313	32284 32314	32285 32315	32286 32316

TWS S

Modulo a LED integrato superluminoso multifunzione / Superbright multifunctional integrated LED light module / Élément extra lumineux à LED intégrée multifonctionnel

12/24V ACDC allCOLOR	33411 33421	33412 33422	33413 33423	33414 33424	33415 33425	33416 33426
12/24V ACDC allCLEAR	33431 33441	33432 33442	33433 33443	33434 33444	33435 33445	33416 33426

TWS RGA

Modulo a LED integrato superluminoso multicolore / Superbright multicolor integrated light module / Élément extra lumineux multicolore à LED intégrée

12/24V ACDC	33447	33448

TWS STEADY/FLASHING*

Modulo tradizionale con attacco BA15d / Light module with traditional BA15d lamp holder / Élément lumineux avec douille BA15d

STEADY (luce fissa / steady light / lumière fixe)

12/240V ACDC	27701 27631	27702 27632	27703 27633	27704 27634	27705 27635	27706 27636

* Fornito senza lampada / Supplied without bulb / Fourni sans ampoule

FLASHING (luce lampeggiante / flashing light / lumière clignotante)

12/48V DC	27711 27641	27712 27642	27713 27643	27714 27644	27715 27645	27716 27646
24/240V AC	27721 27651	27722 27652	27723 27653	27724 27654	27725 27655	27726 27656

* Fornito senza lampada / Supplied without bulb / Fourni sans ampoule



TWS X

Modulo con lampada a scarica di Xenon / Light module with integrated Xenon discharge lamp / Élément lumineux avec tube à décharge au Xénon



												
24V ACDC	27731	27661	27732	27662	27733	27663	27734	27664	27735	27665	27736	27666
110V AC	27741	27671	27742	27672	27743	27673	27744	27674	27745	27675	27746	27676
240V AC	27751	27681	27752	27682	27753	27683	27754	27684	27755	27685	27756	27686

ACUSTICHE / SOUNDERS / ACOUSTIQUES

Modulo acustico piezoelettrico / Piezoelectric acoustic module / Élément acoustique piézoélectrique

		
PZ0		
12/48V ACDC	27718	27625
110/240V AC	27719	27628

Modulo acustico magnetodinamico / Magnetodynamic sounder / Élément acoustique magnétodynamique

		
MDA		
12/24V ACDC	27790	27794
48V AC	27791	27795
110V AC	27792	27796
240V AC	27793	27797

Modulo acustico magnetodinamico IP65 / Magnetodynamic sounder IP65 / Élément acoustique magnétodynamique IP65

		
A+		
12/24V ACDC	33400	33402
110/240V AC	33401	33403

TWS HD

	SS	AL
CUSTODIA / ENCLOSURE / BOÎTIER (2) MODULI - MODULES - ELEMENTS	27602	27603
CUSTODIA / ENCLOSURE / BOÎTIER (3) MODULI - MODULES - ELEMENTS	27677	27840
CUSTODIA / ENCLOSURE / BOÎTIER (4) MODULI - MODULES - ELEMENTS	27606	27607

BASI TWS HD / TWS HD MOUNTERS / SUPPORTS TWS HD

Vendute separatamente, indispensabili per l'installazione

Sold separately, necessary for the installation

Vendus séparément, indispensables pour l'installation

	SS	AL
BASE PIANA / FLAT MOUNTER / BASE PLATE	27679	27841
BASE PALO / POLE MOUNTER / BASE TUBE	27678	27842
BASE LATERALE / SIDE MOUNTER / SUPPORT LATERAL	27680	27843

ACCESSORI / ACCESSORIES / ACCESSOIRES

		
BP1	27762	27693
BP2	27763	27694
SB	33357	33358
BS	27760	27691
KIT	27764	27695
PR	27761	27692
M16	27777	27778
KIT SS L10	27765	27845
KIT SS L20	27766	27846
KIT SS L40	27767	27847

miniTWS

La linea **miniTWS** presenta le medesime caratteristiche della versione 70 mm in termini di sicurezza elettrica e semplicità di montaggio, offrendo una dimensione più compatta (Ø 50 mm), adatta a macchinari di dimensioni più contenute o alla segnalazione in prossimità dell'operatore. I moduli, interamente a LED, offrono versatilità e facilità d'installazione oltre alla possibilità di montare un modulo acustico e di sfruttare l'intera gamma accessori **TWS**.

Disponibile in colore grigio (industriale) e nero (industriale), la gamma **miniTWS** è particolarmente adatta all'utilizzo in ambientazioni di carattere civilistico in cui la segnalazione luminosa è importante ma dove un basso impatto a livello estetico è fondamentale.



miniTWS

The **miniTWS** range has the same safety and assembly characteristics as the 70 mm version. It is a compact version (Ø 50 mm) suitable for installation on smaller machines or to provide signaling in the vicinity of the operator. The light modules are fitted with integrated LEDs.

Available in gray (industrial) and black (industrial), the **miniTWS** range is particularly suitable for use in civil environments where the signaling function is important but where the overall appearance of the stacklight shall remain minimal.

Can be complemented with a sounder module and can be used with the complete range of **TWS** accessories.



miniTWS

Le **miniTWS** a les mêmes caractéristiques de sécurité et de montage que la version 70 mm. Il s'agit d'une version compacte (Ø 50 mm) adaptée pour une installation sur des machines plus petites pour fournir une signalisation en proximité de l'opérateur.

Les éléments lumineux sont équipés de LED intégrées.

Disponibile en gris (industriel) et noir (industriel), la gamme **miniTWS** est particulièrement adaptée pour une utilisation en environnements civils où la fonction de signalisation est importante, mais où l'aspect global de la colonne lumineuse doit rester discret.

La colonne lumineuse peut être complétée avec un élément acoustique et être utilisée avec la gamme complète d'accessoires **TWS**.



miniTWS



allCLEAR

allCOLOR

miniTWS



miniTWS				miniTWS SOUNDER			
V ACDC	24	-	-	V ACDC	24	-	-
V AC	-	110	240	V AC	-	110	240
mA	30	65	55	mA	130	10	15
				dB(A)1m		77	

Base cablaggio
Wiring base
Base de câblage



Modulo acustico
Sounder module
Élément acoustique



Modulo / Module / Élément



Modulo / Module / Élément



Codici / Codes

miniTWS

Riferimenti pagina 164, paragrafo "miniTWS"
See page 164, section "miniTWS"
Voir page 164, section "miniTWS"

MODULO LUMINOSO

Modulo luminoso a LED integrato con funzione STEADY (luce fissa) e FLASHING (luce lampeggiante). miniTWS offre una manutenzione teoricamente nulla grazie alla tecnologia a LED che garantisce 100.000* ore d'utilizzo. Disponibile con lente allCOLOR o allCLEAR.

* In condizioni normali, in assenza di vibrazioni e sbalzi di temperatura

Tensione operativa

24V ACDC, 110V AC, 240V AC +/-10%

Caratteristiche meccaniche

Polycarbonato autoestinguento ad alta resistenza agli impatti, adatto per utilizzo esterno grazie al grado di protezione IP66, UL TYPE 4X, garantito dalla doppia guarnizione in poliuretano presente su ogni modulo.

Caratteristiche luminose

Lente con rigatura verticale per una perfetta distribuzione della luce a 360°.

2 effetti luminosi: luce fissa, lampeggiante.

Disponibile con 2 tipi di lente: allCOLOR (lente colorata con fonte luminosa colorata) e allCLEAR (lente neutra con fonte luminosa colorata), vedi pagina 132.

MODULO ACUSTICO

Modulo acustico magnetodinamico con suono bitonale, frequenza 800/1000Hz.

BASE DI CABLAGGIO

Base indispensabile per il cablaggio della colonna luminosa miniTWS. Dispone di un contatto comune + 5 contatti indipendenti per consentire l'assemblaggio di un massimo di 5 moduli luminosi o 4 moduli luminosi + 1 modulo acustico. Fornita con cappello per la chiusura superiore della colonna, nel caso non sia impiegato il modulo acustico.

Certificazioni / Certifications

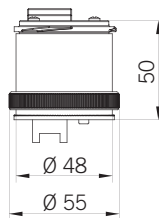

MODULO LUMINOSO
LIGHT MODULE
ÉLÉMENT LUMINEUX

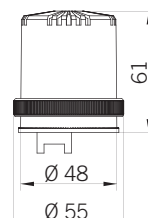

MODULO ACUSTICO
SOUNDER MODULE
ÉLÉMENT ACOUSTIQUE

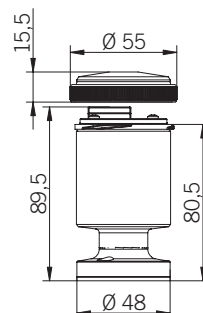

BASE CABLAGGIO
WIRING BASE
BASE DE CÂBLAGE



LIGHT MODULE

Integrated LED light module can be set to STEADY or FLASHING via internal jumper. miniTWS offers versatility and excellent optical performance as well as virtually zero maintenance thanks to the built-in LED technology that guarantees up to 100.000* hours of product life. Available with allCOLOR and allCLEAR lens.

* At normal conditions, without vibrations and heavy temperature changes

Voltagés

24V ACDC, 110V AC, 240V AC +/-10%

Mechanical features

Self-extinguishing PC body with high impact resistance, suitable for outdoor use thanks to the IP66, UL TYPE 4X protection grade, guaranteed by a double polyurethane gasket on each module.

Optical features

The vertically lined lens allows a perfect light distribution over 360°.

2 light effects: steady, flashing light.

Available with 2 different lens types, allCOLOR (colored lens with colored light source) and allCLEAR (clear lens with colored light source), see page 132.

SOUNDER MODULE

Magnetodynamic module with bitonal sound, frequencies 800/1000Hz

WIRING BASE

Wiring base necessary for miniTWS stacklight installation. It offers one common + 5 independent contacts and allows assembly of maximum 5 light modules or 4 light modules + 1 acoustic module. Provided with top cap to be used when the acoustic module is not installed.



ÉLÉMENT LUMINEUX

Élément lumineux à LED intégrée. Il peut être réglé sur STEADY (lumière fixe) ou FLASHING (lumière clignotante). miniTWS offre un entretien quasi-nul grâce à la technologie intégrée du LED qui garantit jusqu'à 100.000* heures de vie au produit. Disponible avec lentille allCOLOR ou allCLEAR.

* Dans des conditions normales, sans vibrations et sans variations importantes de température

Tension d'utilisation

24V ACDC, 110V AC, 240V AC +/-10%

Caractéristiques mécaniques

Polycarbonate autoextinguible, haute résistance aux chocs, adapté pour une utilisation à l'extérieur grâce au degré de protection IP66, UL TYPE 4X, garanti par un double joint en polyuréthane sur chaque élément.

Caractéristiques optiques

La lentille striée en verticale permet une répartition parfaite de la lumière sur 360°.

2 effets lumineux : lumière fixe ou clignotante

Disponible avec 2 différents types de lentilles : allCOLOR (lentille colorée et source lumineuse colorée) ou allCLEAR (lentille incolore transparente avec source lumineuse colorée), voir page 132.

ÉLÉMENT ACOUSTIQUE

Élément magnétodynamique avec son bitonal, fréquence 800/1000Hz

BASE DE CÂBLAGE

Base de câblage pour la gamme miniTWS. La base comporte un contact commun + 5 contacts indépendants, permettant le montage maximum de 5 éléments lumineux ou 4 éléments lumineux + 1 élément acoustique. Base de câblage complète avec couvercle, à utiliser lorsque l'élément acoustique n'est pas installé.

babyTWS

La linea **babyTWS** è nata per soddisfare quelle esigenze dove è necessario l'utilizzo di una colonna compatta e dalle elevate performance ottiche ed estetiche.

Disponibile nel colore grigio (industriale), la gamma **babyTWS** è particolarmente adatta all'utilizzo in ambientazioni di carattere civilistico in cui la segnalazione luminosa è importante ma dove un basso impatto a livello estetico è fondamentale.

babyTWS dispone inoltre di un modulo acustico e può essere utilizzata con tutta la gamma di accessori **TWS**.



babyTWS

The **babyTWS** range has been developed to fulfil all applications where a compact-size stacklight is required, and where aesthetic is a must.

Available in gray (industrial), the **babyTWS** range is particularly suitable for use in civil environments where the signaling function is important but where the overall appearance of the stacklight shall remain minimal.

Can be complemented with a sounder module and can be used with the complete range of **TWS** accessories.



babyTWS

Le **babyTWS** a été développé pour répondre à toutes les applications où il est nécessaire d'utiliser une colonne lumineuse de taille compacte, et où hautes performances optiques et esthétiques sont indispensables.

Disponibile en gris (industriel), la gamme **babyTWS** est particulièrement adaptée pour une utilisation en environnements civils où la fonction de signalisation est importante, mais où l'aspect global de la colonne lumineuse doit rester discret.

Le **babyTWS** peut être complété avec un élément acoustique et peut être utilisé avec la gamme complète d'accessoires **TWS**.



babyTWS



allCLEAR

babyTWS

Modulo / Module / Élément



babyTWS

V ACDC	24
mA	50

babyTWS SOUNDER

V ACDC	24
mA	10
dB(A)1m	72

Base cablaggio
Wiring base
Base de câblageModulo acustico
Sounder module
Élément acoustique

Modulo / Module / Élément



Modulo / Module / Élément



Codici / Codes

babyTWS

Riferimenti pagina 164, paragrafo "babyTWS"
See page 164, section "babyTWS"
Voir page 164, section "babyTWS"

MODULO LUMINOSO

Modulo luminoso a LED integrato con funzione STEADY (luce fissa). babyTWS offre una manutenzione teoricamente nulla grazie alla tecnologia a LED che garantisce 100.000* ore d'utilizzo. Disponibile con lente allCOLOR o allCLEAR.

* In condizioni normali, in assenza di vibrazioni e sbalzi di temperatura

Tensione operativa

24V ACDC +/-10%

Caratteristiche meccaniche

Polycarbonato autoestinguente con grado di protezione IP65, UL TYPE 3R.

Caratteristiche luminose

Lente con rigatura verticale per una perfetta distribuzione della luce fissa a 360°. Disponibile con 2 tipi di lente: allCOLOR (lente colorata con fonte luminosa colorata) e allCLEAR (lente neutra con fonte luminosa colorata), vedi pagina 132.

MODULO ACUSTICO

Modulo acustico piezoelettrico con suono intermittente, frequenza 4000 +/- 300Hz.

BASE DI CABLAGGIO

Base indispensabile per il cablaggio della colonna luminosa babyTWS. Dispone di un contatto comune + 6 contatti indipendenti per consentire l'assemblaggio di un massimo di 6 moduli luminosi o 5 moduli luminosi + 1 modulo acustico.

Fornita con cappello per la chiusura superiore della colonna, nel caso non sia impiegato il modulo acustico.

Certificazioni / Certifications

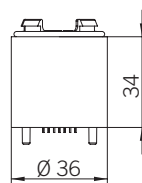

MODULO LUMINOSO
LIGHT MODULE
ELEMENT LUMINEUX

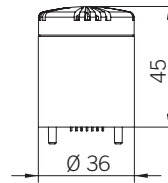

MODULO ACUSTICO
SOUNDER MODULE
ELEMENT ACOUSTIQUE

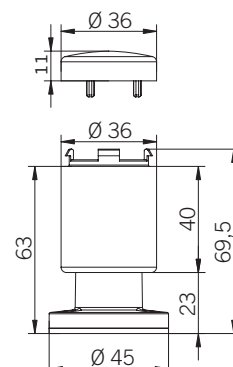

BASE CABLAGGIO
WIRING BASE
BASE DE CÂBLAGE



LIGHT MODULE

Integrated LED STEADY light module. babyTWS offers virtually zero maintenance thanks to the built-in LED technology that guarantees up to 100.000* hours of product life.

Available with allCOLOR and allCLEAR lens.
* At normal conditions, without vibrations and heavy temperature changes

Voltagges

24V ACDC +/-10%

Mechanical features

Self-extinguishing PC body with IP65, UL TYPE 3R protection grade.

Optical features

The vertically lined lens allows a perfect steady light distribution over 360°.

Available with 2 different lens types, allCOLOR (colored lens with colored light source) and allCLEAR (clear lens with colored light source), see page 132.

SOUNDER MODULE

Piezoelectric module with intermittent sound, frequencies 4000 +/- 300Hz.

WIRING BASE

Wiring base necessary for babyTWS stacklight installation. It offers one common + 6 independent contacts and allows assembly of maximum 6 light modules or 5 light modules + 1 acoustic module. Provided with top cap to be used when the acoustic module is not installed.



ELEMENT LUMINEUX

Élément lumineux à LED intégrée à lumière fixe (STEADY). babyTWS offre un entretien quasiment grâce à la technologie intégrée du LED qui garantit jusqu'à 100.000* heures de vie au produit.

Disponible avec lentille allCOLOR ou allCLEAR.

* Dans des conditions normales, sans vibrations et sans variations importantes de température

Tension d'utilisation

24V ACDC +/-10%

Caractéristiques mécaniques

Polycarbonate autoextinguible, degré de protection IP65, UL TYPE 3R.

Caractéristiques optiques

La lentille striée en verticale permet une répartition parfaite de la lumière fixe sur 360°.

Disponible avec 2 différents types de lentilles : allCOLOR (lentille colorée et source lumineuse colorée) ou allCLEAR (lentille incolore transparente avec source lumineuse colorée), voir page 132.

ELEMENT ACOUSTIQUE

Élément piézoélectrique avec son pulsé, fréquence 4000 +/- 300Hz.

BASE DE CÂBLAGE





Base de câblage pour la gamme babyTWS. La base comporte un contact commun + 6 contacts indépendants, permettant le montage maximum de 6 éléments lumineux ou 5 éléments lumineux + 1 élément acoustique.

Base de câblage complète avec couvercle, à utiliser lorsque l'élément acoustique n'est pas installé.

Codici / Codes

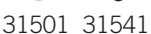



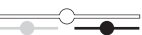

miniTWS

Modulo LED luce fissa/lampeggiante / Integrated LED steady/flashing light module / Élément lumineux à LED intégrée fixe/cligotant

							
aiCOLOR	24V ACDC	31501 31541	31502 31542	31503 31543	31504 31544	31505 31545	31506 31546
	110V AC	31511 31551	31512 31552	31513 31553	31514 31554	31515 31555	31516 31556
	240V AC	31521 31561	31522 31562	31523 31563	31524 31564	31525 31565	31526 31566
aiCLEAR	24V ACDC	33241 33301	33242 33302	33243 33303	33244 33304	33245 33305	31506 31546
	110V AC	33251 33311	33252 33312	33253 33313	33254 33314	33255 33315	31516 31556
	240V AC	33261 33321	33262 33322	33263 33323	33264 33324	33265 33325	31526 31566



babyTWS

Modulo LED luce fissa / Integrated LED steady light module / Élément lumineux fixe à LED intégrée

							
24V ACDC	aiCOLOR	36451	36452	36453	36454	36455	36456
24V ACDC	aiCLEAR	33271	33272	33273	33274	33275	36456

ACUSTICHE / SOUNDERS / ACOUSTIQUES

miniTWS (modulo magnetodinamico / magnetodynamic module / élément magnétodynamique)

		
24V ACDC	31531	31534
110V AC	31532	31535
240V AC	31533	31536

babyTWS (modulo piezoelettrico / piezoelectric module / élément piézoélectrique)

	
24V ACDC	36461

BASI / BASES / BASES

		
miniTWS	31500	31508
babyTWS	36450	

ACCESSORI / ACCESSORIES / ACCESSOIRES

(miniTWS - babyTWS)

		
BP1	27762	27693
BP2	27763	27694
SB	33357	33358
BS	27760	27691
KIT	27764	27695
PR	27761	27692
M16	27777	27778
KIT SS L10	27765	27845
KIT SS L20	27766	27846
KIT SS L40	27767	27847







LAMPADE RICAMBIO / SPARE BULBS / AMPOULES DE RECHANGE



scatola: box: boîte :	1x25 pz. 1x25 pcs. 1x25 pcs.	singola single individuelle	25 pz. 25 pcs. 25 pcs.
12V	70970	70941	27780
24V	70971	70942	27781
48V	70972	70943	27782
110V	70973	70944	27783
240V	70974	70945	27784

BA 15d
5W
TWS STEADY/FLASHING



						
12V ACDC	40931	40932	40933	40934	40935	40936
24V ACDC	40941	40942	40943	40944	40945	40946
110V AC	40951	40952	40953	40954	40955	40956
240V AC	40961	40962	40963	40964	40965	40966

LD 4.5.4 WO
BA 15d
TWS STEADY/FLASHING



2J 71634
TWS X
XENON

ACCESSORI / ACCESSORIES
ACCESSOIRES (TWS - miniTWS - babyTWS)



BS
27760 27691

BS
kg
0,03



PR
kg
0,03

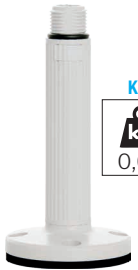

KIT
kg
0,06



KIT SS
kg
0,14

PR 27761 27692
KIT 27764 27695
KIT SS L10 27765 27845
KIT SS L20 27766 27846
KIT SS L40 27767 27847



BP1

BP1
kg
0,04



BP2

BP2
kg
0,05

BP1 27762 27693
BP2 27763 27694



SB

SB 33357 33358

SB
kg
0,14



M16

M16 27777 27778

M16
kg
0,10

BS

- Base piana per montaggio superficiale
- Flat base for surface mount
- Base pour montage à plat

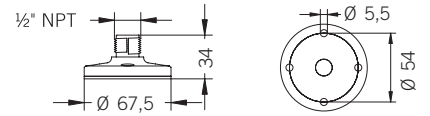

PR

- Prolunga 10 cm
- 10 cm extension
- 10 cm de prolongation

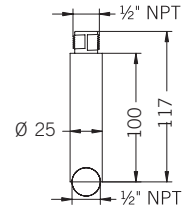

KIT

- Base piana per montaggio superficiale con estensione di 10 cm
- Flat base for surface mount with 10 cm extension
- Base pour montage à plat avec 10 cm de prolongation

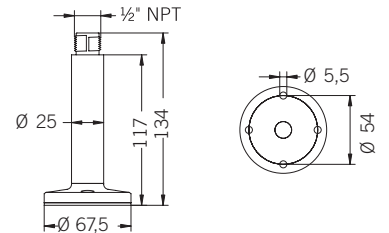

KIT SS L10 - L20 - L40

- Base piana per montaggio superficiale con estensione in acciaio INOX di 10 cm (disponibile anche con misura 20 e 40 cm)
- Flat base for surface mount with 10 cm stainless steel extension (also available in 20 and 40 cm sizes)
- Base pour montage à plat avec extension en acier inoxydable de 10 cm (aussi disponible en taille de 20 et 40 cm)

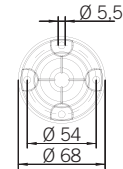

BP1

- Base parete per montaggio laterale
- Wall base for side mount
- Support fixation en applique (à filetage simple)

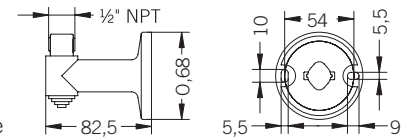

BP2

- Base parete per montaggio laterale di 2 colonne
- Wall base for side mount of 2 towers
- Support fixation en applique (à double filetage) pour 2 colonnes lumineuses

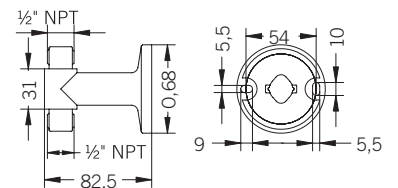

SB

- Staffa in acciaio INOX per montaggio laterale con pressacavo 1/2" NPT
- Stainless steel bracket with 1/2" NPT cable gland
- Support en acier inoxydable avec un presse-étoupe 1/2" NPT

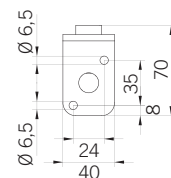

M16

- Base piana per montaggio superficiale con pressacavo M16
- Flat base with M16 cable gland for surface mount
- Base pour montage à plat avec presse-étoupe M16

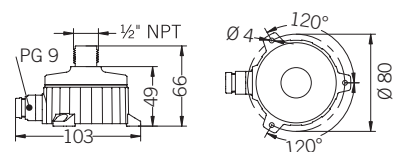

GAMMA LUXOR

La linea **LUXOR**, grazie alla sua grande versatilità di composizione, nasce per rispondere anch'essa alle moderne esigenze di segnalazione industriale, risolvendo ogni problema di installazione in quanto è l'unica sul mercato ad avere un diametro di 136 mm (**LUXOR 4**), questo fa sì che si adatti ad ambienti, spazi e macchinari di vari dimensioni.



LUXOR RANGE

The **LUXOR** stacklights have been developed to meet modern requirements in industrial signaling. It is the only stacklight on the market with a diameter of 136 mm (**LUXOR 4**) and, thanks to the numerous configurations offered, solves all types of installation solutions in larger-size industrial sites and machinery.



GAMME LUXOR

Les colonnes lumineuses **LUXOR** ont été développées pour répondre aux exigences actuelles de la signalisation industrielle. **LUXOR** est l'unique colonne lumineuse d'un diamètre de 136 mm (**LUXOR 4**) et, grâce aux nombreuses configurations proposées, elle est la réponse à tous types d'installation pour les machines et les sites industriels de plus grande taille.



LUXOR LED

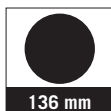

LX4

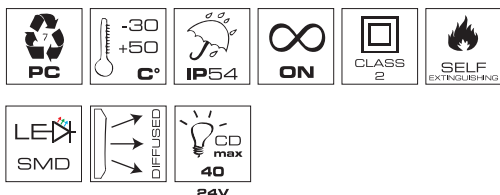

LUXOR LED 4

V DC	24	-
V AC	-	24
mA	95	75

Codici / Codes

LUXOR LED LX4

24V ACDC

16663*

24V ACDC

16664**

* Fornito con piedini di fissaggio / Supplied with mounting feet
Fourni avec pieds de fixation** Predisposizione per SUPPORTO BASE 72625, necessario per l'installazione
Ready for SUPPORT BASE 72625, necessary for installation
Prédisposé pour SUPPORT DE BASE 72625, nécessaire pour l'installation

RICAMBI / SPARE PARTS / RECHANGES

SMD PCB LX4 071 F 324 72626

SMD PCB LX4 071 F 423 72627

RICAMBI CUPOLE / SPARE DOMES / DOMES DE RECHANGES

LX4 72731 72732 72733

Colonna luminosa a 3 stadi (verde, ambr, rosso) disponibile nel diametro 136 mm (LX4). Fonte luminosa con LED integrato colorato che consente l'ottimizzazione della frequenza cromatica emessa, garantendo colori brillanti. Grazie alla dimensione importante della colonna, LUXOR LED si sposa particolarmente bene con le esigenze di segnalazione della grande industria e dei grandi impianti di automazione. Proposto con base per fissaggio su superficie piana, sono disponibili inoltre diversi tipi di base e accessori per soddisfare le esigenze più sofisticate.

Tensione operativa

24V ACDC +/-10%

Caratteristiche meccaniche

Cupole in policarbonato autoestinguente ad alta resistenza agli impatti. Base e cappello in nylon rinforzato con fibra di vetro PA66 FV30.

Caratteristiche luminose

Lente con rigatura verticale per una perfetta distribuzione della luce fissa a 360°. Disponibile con lenti allCOLOR (lente colorata con fonte luminosa colorata), vedi pagina 132.

Certificazioni / Certifications



Ø 136

LX4



Large size 3 stage stacklight (green, amber, red) available with diameter 136 mm LX4. An integrated LED luminous source allows maximizing color emission frequency guaranteeing an outstanding color output. Thanks to its larger size, LUXOR LED is particularly indicated for larger scale automated installation. Configured with a flat mounting base, a wide selection of accessories to facilitate all mounting scenarios is available.

Voltages

24V ACDC +/-10%

Mechanical features

Self-extinguishing PC domes with high impact resistance. Body in fiber glass reinforced nylon (PA66 FV30).

Optical features

The vertically lined lens allows a perfect steady light distribution over 360°. Available with allCOLOR lens (colored lens with colored light source), see page 132.



LUXOR LED est la colonne lumineuse de grande taille avec 3 éléments (vert, orange, rouge), disponible en diamètre 136 mm LX4.

Une source lumineuse à LED intégrée permet de maximiser la fréquence d'émission, garantissant une perception exceptionnelle des couleurs. Grâce à sa grande taille, LUXOR LED est particulièrement indiqué pour les exigences de signalisation de la grande industrie et de l'automatisme.

Configuré avec une base de montage plate, un large choix d'accessoires pour faciliter tous les scénarios de fixation est aussi disponible.

Tension d'utilisation

24V ACDC +/-10%

Caractéristiques mécaniques

Dômes en polycarbonate autoextinguible, haute résistance aux chocs. Corps en polyamide renforcé fibre de verre (PA66 FV30).

Caractéristiques optiques

La lentille striée en verticale permet une répartition parfaite de la lumière fixe sur 360°. Disponible avec lentille allCOLOR (lentille colorée et source lumineuse colorée), voir page 132.

ACCESSORI / ACCESSORIES / ACCESSOIRES (LX4 16663)



LX4 PR4 A 72673

PROLUNGA RIGIDA
RIGID EXTENSION
TIGE RIGIDE

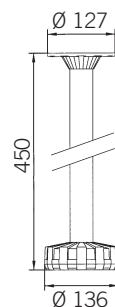

PR4 A



LX4 BT4 72683

BASE PER TUBO
BASE FOR TUBE
BASE POUR TIGE

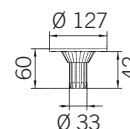

BT4



SUPPORTO BASE PER LX4 16664 (indispensabile per l'installazione dell'articolo)
SUPPORT BASE FOR LX4 16664 (necessary for the installation of the product)
SUPPORT BASE POUR LX4 16664 (nécessaire pour l'installation du produit)



LX4 SUPPORT BASE 72625



SUPPORTO BASE
SUPPORT BASE
SUPPORT DE BASE

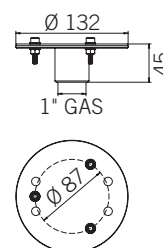

SUPPORT
BASE



CERTIFICAZIONI CERTIFICATIONS CERTIFICATIONS

Le gamme **ELYPS**, **TWS** e **LUXOR** sono certificate secondo gli standard CE (EN60598-1, EN61000-6-3, EN61000-6-2).

The **ELYPS**, **TWS** and **LUXOR** ranges are certified according to CE (EN60598-1, EN61000-6-3, EN61000-6-2) standards.

Les gammes **ELYPS**, **TWS** et **LUXOR** sont conformes aux normes CE (EN60598-1, EN61000-6-3, EN61000-6-2).



La gamma **TWS** ha ottenuto la certificazione GOST che ne consente l'utilizzo nella regione CIS secondo gli standard locali.

The **TWS** range also achieved GOST certification and can be used in the CIS region according to local standards.

La gamme **TWS** a également obtenu la certification GOST et peut être utilisée dans la région de la CIS conformément aux normes locales.



Il prodotto **TWS HD**, utilizzabile con le colonne luminose della serie **TWS**, è stato certificato dal TÜV SÜD secondo gli standard del grado di protezione IP69K.

TWS HD (to be used in conjunction with the **TWS** range) has been certified according to IP69K protection grade standards by TÜV SÜD.

TWS HD peut être utilisé avec la gamme **TWS** et il a été certifié conformément aux normes de protection IP69K par TÜV SÜD.



TWS ed **ELYPS** hanno ottenuto la certificazione UL per Stati Uniti e Canada con grado di protezione TYPE 4X, il più alto nella sua categoria.

TWS and **ELYPS** have achieved UL certification for US and Canada with protection grade TYPE 4X, the highest in its category.

TWS et **ELYPS** ont obtenu la certification UL pour les Etats-Unis et le Canada, degré de protection TYPE 4X, le plus élevé de sa catégorie.



MODEL	ELECTRICAL RATING	MAXIMUM AMBIENT TEMPERATURE ALLOWED
TWS BC	Max 240V ACDC	60° C
TWS STEADY	12V ACDC	59° C
	24V ACDC	60° C
	48V ACDC	57° C
	110, 240V ACDC	60° C
	TWS FLASHING	12/48V DC
TWS X	24/48V AC	60° C
	110, 240V AC	54° C
	TWS LED	24V ACDC
TWS LED	110, 240V AC	43° C
	TWS S	24V ACDC
TWS RGA	12/24V ACDC	60° C
TWS PZO	12/48V ACDC	60° C
	110/240V AC	56° C
	TWS MDA	12/24V ACDC
TWS MDA	48V AC	55° C
	110, 240V AC	50° C
	TWS A+	12/24V ACDC
TWS A+	110/240V AC	60° C
	miniTWS	24V ACDC
miniTWS BC	Max 240V ACDC	50° C
miniTWS A	24V ACDC	50° C
babyTWS	24V ACDC	50° C
babyTWS BC	Max 24V ACDC	50° C
babyTWS A	24V ACDC	50° C



FOUR

Indicatori a LED per la gestione di accessi e camminamenti
LED Indicators for access points and private path management
Avertisseurs lumineux à LED pour la gestion de points
et chemins d'accès

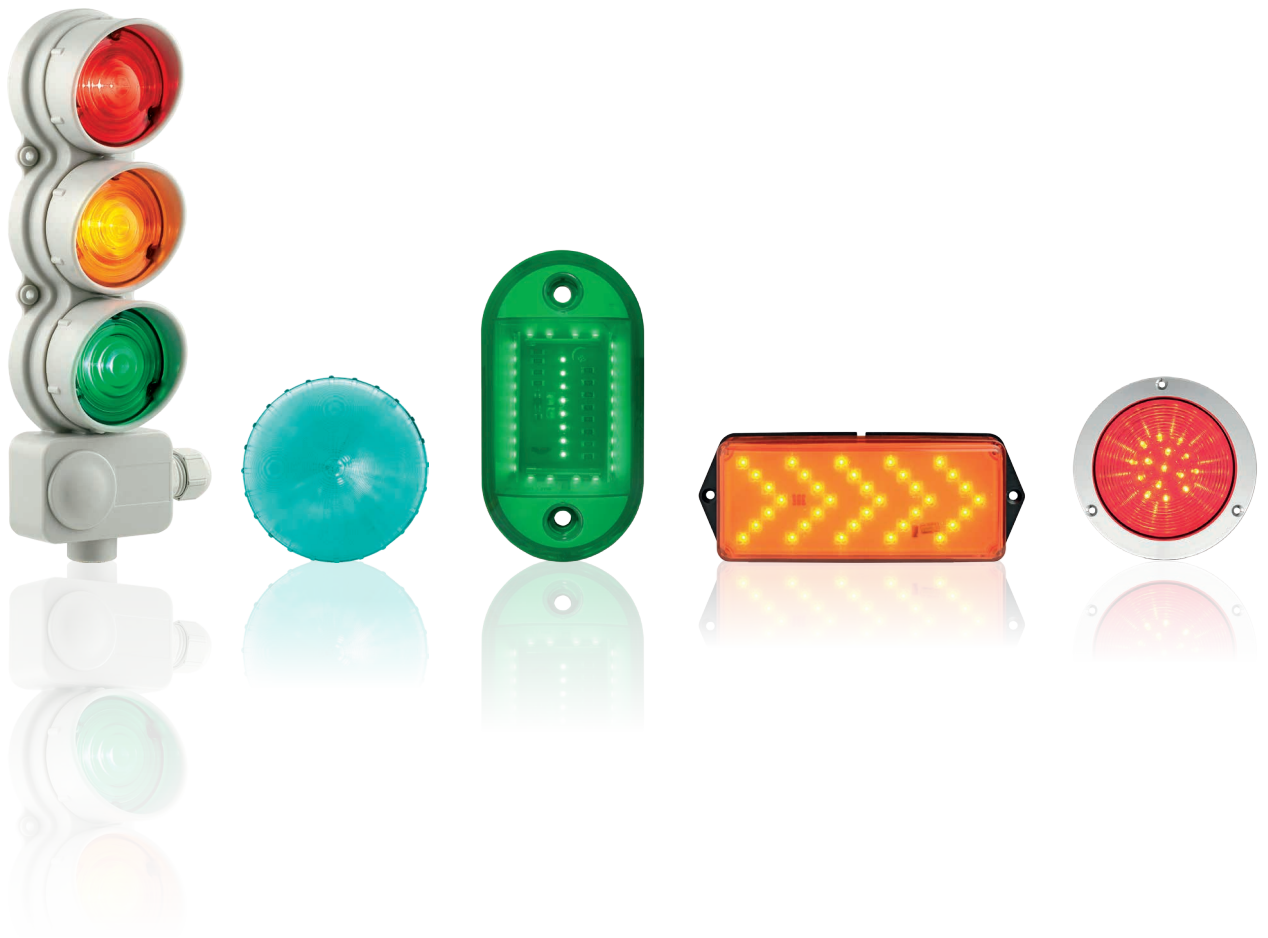

SIRENA

INTRODUZIONE

Con la gamma **FOUR** Sirena propone indicatori a LED per la segnalazione in diverse situazioni nell'ambito dell'ingegneria edile, meccanica e del controllo degli accessi.

I segnalatori **FOUR** sono stati sviluppati da Sirena per soddisfare la crescente domanda di un dispositivo su misura per queste applicazioni. La sicurezza di varchi e punti di accesso è la priorità per i professionisti del settore, sempre volti alla ricerca degli standard più elevati per i propri clienti.

Soluzioni luminose versatili: SMFR LD (semafori industriali a LED, disponibile in 3 misure), FEU LED 2.0 (lampade semaforiche a LED, disponibili in 2 misure), F4 LED (dispositivo a LED per la segnalazione direzionale in parcheggi e camminamenti), R4 LED (dispositivo a LED per la segnalazione di priorità per varchi e punti di accesso) e T4 LED (segnalatore luminoso per il controllo degli accessi).



INTRODUCTION

With **FOUR** range Sirena offers LED indicators for signalization in different scenarios like building technology, mechanical engineering and access control systems.

FOUR signaling devices have been developed by Sirena to fulfill the increasing demand for a device specifically tailored for these growing applications.

Gates and access points safety is a growing priority for Professionals always aiming to provide the highest standards to customers.

Versatile luminous solutions: SMFR LD (LED industrial traffic lights, available in 3 dimensions), FEU LED 2.0 (LED bulbs for traffic lights, available in 2 dimensions), F4 LED (directional signaling LED device for parking and private paths), R4 LED (priority signaling LED device engineered for gates and access points) and T4 LED (luminous indicator for access control systems).



INTRODUCTION

La gamme **FOUR** de Sirena propose avertisseurs lumineux à LED pour la signalisation dans différents domaines comme la technologie de construction, l'ingénierie mécanique et le contrôle d'accès.

Les avertisseurs **FOUR** ont été développés pour satisfaire la demande croissante d'un dispositif spécifiquement adapté à ces applications.

La sécurité des portes et des points d'accès a acquis une importance croissante pour les professionnels, toujours à la recherche de solutions haut de gamme pour les clients.

Solutions lumineuses polyvalentes : SMFR LD (feux de signalisation industrielle à LED, disponibles en 3 dimensions), FEU LED 2.0 (ampoules à LED pour feu de signalisation, disponibles en 2 dimensions), F4 LED (dispositif de signalisation directionnelle à LED pour parkings et accès privés), R4 LED (dispositif de signalisation à LED pour portes et points d'accès) et T4 LED (dispositif à LED pour le contrôle d'accès).

174 **Semafori Industriali** **Industrial Traffic Lights** **Feux de Signalisation Industrielle**

174	SMFR 6.3 LD 8Q
175	SMFR 6.2 LD 8Q
176	SMFR 9.3 LD 16Q
177	SMFR 9.2 LD 16Q
178	SMFR 12.3 LD 24Q
179	SMFR 12.2 LD 24Q



180 **Lampade semaforiche a LED** **LED Bulb for traffic lights** **Ampoules à LED pour feux de signalisation**

180	FEU LED 2.0 200 - 300
-----	-----------------------



181 **Dispositivo a LED per segnalazione direzionale** **Directional signaling LED device** **Dispositif de signalisation directionnelle à LED**

181	F4 LED
-----	--------



182 **Dispositivo a LED per la gestione dei punti di accesso** **Priority signaling LED device for access points management** **Dispositif de signalisation à LED pour la gestion de points d'accès**

182	R4 LED
-----	--------



183 **Dispositivo a LED per il controllo dei punti di accesso** **LED device for access control systems** **Dispositif à LED pour le contrôle de points d'accès**

183	T4 LED
-----	--------



SMFR 6.3 LD 8Q



SMFR 6.3 LD 8Q

SMFR 6.3 LD 8Q A

Corpo / Body / Corps

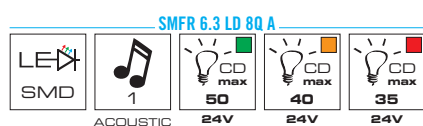
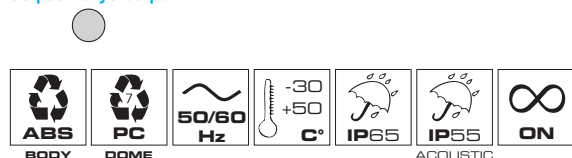

SMFR 6.3 LD 8Q

V ACDC	12	24	48	-	-
V AC	-	-	-	110	240
mA*	30	30	30	15	20

SMFR 6.3 LD 8Q A

V ACDC	12	24	48	-	-
V AC	-	-	-	110	240
mA*	40	40	40	20	30
dB(A)1m	82				

* I dati di assorbimento si riferiscono ad una sola sezione luminosa
Power consumption data refer to one light source only
Les données de consommation se réfèrent à une seule section lumineuse

Codici / Codes

SMFR 6.3 LD 8Q

12V ACDC	69410
24V ACDC	69411
48V ACDC	69412
110V AC	69413
240V AC	69414

SMFR 6.3 LD 8Q A

12V ACDC	69441
24V ACDC	69442
48V ACDC	69443
110V AC	69444
240V AC	69445

Semaforo industriale a LED progettato per la segnalazione in diverse situazioni nell'ambito dell'ingegneria edile, meccanica e del controllo degli accessi.

I semafori **SMFR 6.3 LD 8Q** sono dotati di tecnologia LED a luce fissa (luce lampeggiante a richiesta) e sono disponibili anche con segnalazione acustica integrata **SMFR 6.3 LD 8Q A**.

Tensione operativa

12V ACDC, 24V ACDC, 48V ACDC, 110V AC, 240V AC +/-10%

Caratteristiche meccaniche

Corpo in ABS e cupole in PC. Guarnizioni cupole in PVC e coperchio retro luci in Forprene. Dotato di pressacavo M20.

Caratteristiche luminose

Gruppo ottico costituito da 8 LED quadrati ad elevata definizione ottica. Le cupole appositamente studiate permettono di magnificare il fascio luminoso fisso (luce lampeggiante a richiesta).

Caratteristiche acustiche

SMFR 6.3 LD 8Q A: buzzer acustico. Suono intermittente F/m 110. Frequenza: 4000Hz+/-300

Certificazioni / Certifications

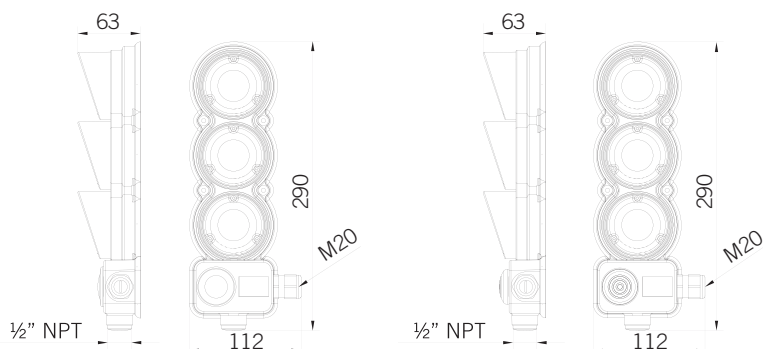

SMFR 6.3 LD 8Q



SMFR 6.3 LD 8Q A



LED industrial traffic light engineered for signalization in different scenarios like building technology, mechanical engineering and access control systems.

SMFR 6.3 LD 8Q traffic lights benefit from steady light LED technology (flashing light version on request). Version with integrated acoustic signalization **SMFR 6.3 LD 8Q A** also available.

Voltages

12V ACDC, 24V ACDC, 48V ACDC, 110V AC, 240V AC +/-10%

Mechanical features

ABS body and PC domes. PVC dome gaskets and Forprene rear light covers. Equipped with M20 cable gland.

Optical features

Optical group made up of 8 square LEDs with high optical performance. Domes engineered to intensify the steady light beam (flashing light available on request).

Acoustic features

SMFR 6.3 LD 8Q A: acoustic buzzer. Intermittent sound F/m 110. Frequency: 4000Hz+/-300



Feu de signalisation industrielle à LED développé pour la signalisation dans différents domaines comme la technologie de construction, l'ingénierie mécanique et le contrôle d'accès.

Les feux de trafic **SMFR 6.3 LD 8Q** ont été développés avec une technologie LED à lumière fixe (lumière clignotante disponible sur demande) et sont disponibles avec signalisation acoustique intégrée **SMFR 6.3 LD 8Q A**.

Tension d'utilisation

12V ACDC, 24V ACDC, 48V ACDC, 110V AC, 240V AC +/-10%

Caractéristiques mécaniques

Corps en ABS et dômes en PC. Joints dômes en PVC et couvercles postérieurs feux en Forprene. Equipé avec presse-étoupe M20.

Caractéristiques optiques

Groupe optique avec 8 LED carrées à haute définition optique. Les dômes permettent d'augmenter le faisceau lumineux à lumière fixe (lumière clignotante disponible sur demande).

Caractéristiques acoustiques

SMFR 6.3 LD 8Q A : buzzer acoustique. Son pulsé F/m 110. Fréquence : 4000Hz+/-300

SMFR 6.2 LD 8Q



SMFR 6.2 LD 8Q

SMFR 6.2 LD 8Q A

Corpo / Body / Corps

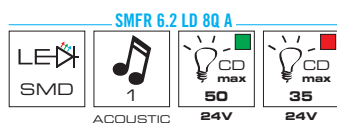
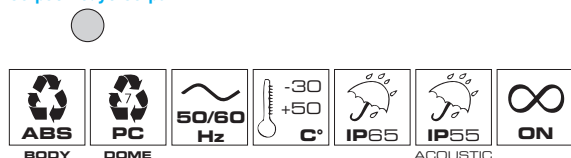

SMFR 6.2 LD 8Q

V ACDC	12	24	48	-	-
V AC	-	-	-	110	240
mA*	30	30	30	15	20

SMFR 6.2 LD 8Q A

V ACDC	12	24	48	-	-
V AC	-	-	-	110	240
mA*	40	40	40	20	30
dB(A)1m	82				

* I dati di assorbimento si riferiscono ad una sola sezione luminosa
Power consumption data refer to one light source only
Les données de consommation se réfèrent à une seule section lumineuse

Codici / Codes

SMFR 6.2 LD 8Q

12V ACDC	69426
24V ACDC	69427
48V ACDC	69428
110V AC	69429
240V AC	69430

SMFR 6.2 LD 8Q A

12V ACDC	69456
24V ACDC	69457
48V ACDC	69458
110V AC	69459
240V AC	69460

Semaforo industriale a LED progettato per la segnalazione in diverse situazioni nell'ambito dell'ingegneria edile, meccanica e del controllo degli accessi.

I semafori **SMFR 6.2 LD 8Q** sono dotati di tecnologia LED a luce fissa (luce lampeggiante a richiesta) e sono disponibili anche con segnalazione acustica integrata **SMFR 6.2 LD 8Q A**.

Tensione operativa

12V ACDC, 24V ACDC, 48V ACDC, 110V AC, 240V AC +/-10%

Caratteristiche meccaniche

Corpo in ABS e cupole in PC. Guarnizioni cupole in PVC e coperchio retro luci in Forprene. Dotato di pressacavo M20.

Caratteristiche luminose

Gruppo ottico costituito da 8 LED quadrati ad elevata definizione ottica. Le cupole appositamente studiate permettono di magnificare il fascio luminoso fisso (luce lampeggiante a richiesta).

Caratteristiche acustiche

SMFR 6.2 LD 8Q A: buzzer acustico. Suono intermittente F/m 110. Frequenza: 4000Hz+/-300

Certificazioni / Certifications

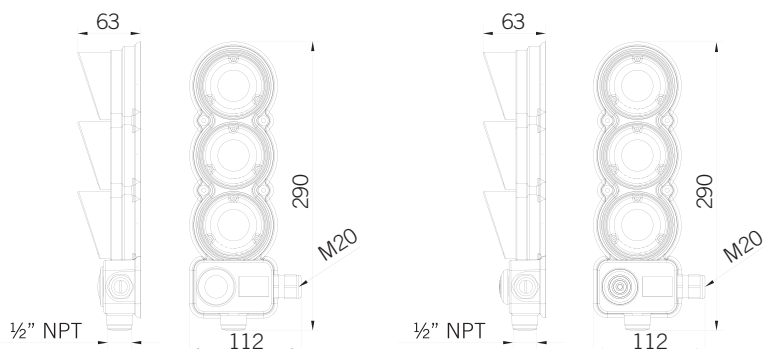

SMFR 6.2 LD 8Q



SMFR 6.2 LD 8Q A



LED industrial traffic light engineered for signalization in different scenarios like building technology, mechanical engineering and access control systems.

SMFR 6.2 LD 8Q traffic lights benefit from steady light LED technology (flashing light version on request). Version with integrated acoustic signalization **SMFR 6.2 LD 8Q A** also available.

Voltages

12V ACDC, 24V ACDC, 48V ACDC, 110V AC, 240V AC +/-10%

Mechanical features

ABS body and PC domes. PVC dome gaskets and Forprene rear light covers. Equipped with M20 cable gland.

Optical features

Optical group made up of 8 square LEDs with high optical performance. Domes engineered to intensify the steady light beam (flashing light available on request).

Acoustic features

SMFR 6.2 LD 8Q A: acoustic buzzer. Intermittent sound F/m 110. Frequency: 4000Hz+/-300



Feu de signalisation industrielle à LED développé pour la signalisation dans différents domaines comme la technologie de construction, l'ingénierie mécanique et le contrôle d'accès.

Les feux de trafic **SMFR 6.2 LD 8Q** ont été développés avec une technologie LED à lumière fixe (lumière clignotante disponible sur demande) et sont disponibles avec signalisation acoustique intégrée **SMFR 6.2 LD 8Q A**.

Tension d'utilisation

12V ACDC, 24V ACDC, 48V ACDC, 110V AC, 240V AC +/-10%

Caractéristiques mécaniques

Corps en ABS et dômes en PC. Joints dômes en PVC et couvercles postérieurs feux en Forprene. Equipé avec presse-étoupe M20.

Caractéristiques optiques

Groupe optique avec 8 LED carrées à haute définition optique. Les dômes permettent d'augmenter le faisceau lumineux à lumière fixe (lumière clignotante disponible sur demande).

Caractéristiques acoustiques

SMFR 6.2 LD 8Q A : buzzer acoustique. Son pulsé F/m 110. Fréquence : 4000Hz+/-300

SMFR 9.3 LD 16Q



SMFR 9.3 LD 16Q

SMFR 9.3 LD 16Q A

Corpo / Body / Corps

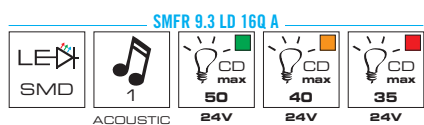
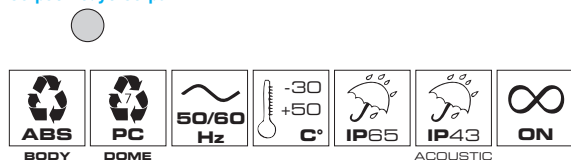

SMFR 9.3 LD 16Q

V DC	12	-	24	-	48	-	-	-
V AC	-	12	-	24	-	48	110	240
mA*	185	145	110	155	40	105	20	20

SMFR 9.3 LD 16Q A

V DC	12	-	24	-	-	-	-
V AC	-	12	-	24	48	110	240
mA*	185	145	110	155	105	20	20
dB(A)1m	90	80	90	90	90	90	90

* I dati di assorbimento si riferiscono ad una sola sezione luminosa
Power consumption data refer to one light source only
Les données de consommation se réfèrent à une seule section lumineuse

Codici / Codes

SMFR 9.3 LD 16Q

12V ACDC	69415
24V ACDC	69416
48V ACDC	69417
110V AC	69418
240V AC	69420

SMFR 9.3 LD 16Q A

12V DC	69569
24V DC	69570
12V AC	69446
24V AC	69447
48V AC	69448
110V AC	69449
240V AC	69450

Semaforo industriale a LED progettato per la segnalazione in diverse situazioni nell'ambito dell'ingegneria edile, meccanica e del controllo degli accessi.

I semafori **SMFR 9.3 LD 16Q** sono dotati di tecnologia LED a luce fissa (luce lampeggiante a richiesta) e sono disponibili anche con segnalazione acustica integrata **SMFR 9.3 LD 16Q A**.

Tensione operativa

SMFR 9.3 LD 16Q: 12V ACDC, 24V ACDC, 48V ACDC, 110V AC, 240V AC +/-10%

SMFR 9.3 LD 16Q A: 12V DC, 24V DC, 12V AC, 24V AC, 48V AC, 110V AC, 240V AC +/-10%

Caratteristiche meccaniche

Corpo in ABS e cupole in PC. Guarnizioni cupole in PVC e coperchio retro luci in Forprene. Dotato di pressacavo M20.

Caratteristiche luminose

Gruppo ottico costituito da 16 LED quadrati ad elevata definizione ottica. Le cupole appositamente studiate permettono di magnificare il fascio luminoso fisso (luce lampeggiante a richiesta).

Caratteristiche acustiche

SMFR 9.3 LD 16Q A: buzzer acustico. Suono continuo.

Frequenza: 650/50Hz

Certificazioni / Certifications

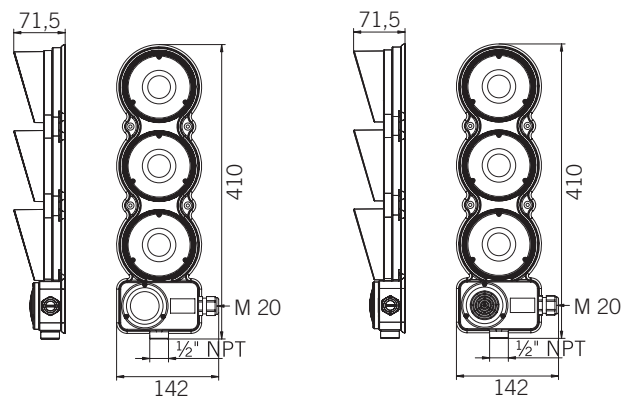

SMFR 9.3 LD 16Q



SMFR 9.3 LD 16Q A



LED industrial traffic light engineered for signalization in different scenarios like building technology, mechanical engineering and access control systems.

SMFR 9.3 LD 16Q traffic lights benefit from steady light LED technology (flashing light version on request). Version with integrated acoustic signalization **SMFR 9.3 LD 16Q A** also available.

Voltages

SMFR 9.3 LD 16Q: 12V ACDC, 24V ACDC, 48V ACDC, 110V AC, 240V AC +/-10%

SMFR 9.3 LD 16Q A: 12V DC, 24V DC, 12V AC, 24V AC, 48V AC, 110V AC, 240V AC +/-10%

Mechanical features

ABS body and PC domes. PVC dome gaskets and Forprene rear light covers. Equipped with M20 cable gland.

Optical features

Optical group made up of 16 square LEDs with high optical performance. Domes engineered to intensify the steady light beam (flashing light available on request).

Acoustic features

SMFR 9.3 LD 16Q A: acoustic buzzer. Continuous sound.
Frequency: 650/50Hz



Feu de signalisation industrielle à LED développé pour la signalisation dans différents domaines comme la technologie de construction, l'ingénierie mécanique et le contrôle d'accès.

Les feux de trafic **SMFR 9.3 LD 16Q** ont été développés avec une technologie LED à lumière fixe (lumière clignotante disponible sur demande) et sont disponibles avec signalisation acoustique intégrée **SMFR 9.3 LD 16Q A**.

Tension d'utilisation

SMFR 9.3 LD 16Q : 12V ACDC, 24V ACDC, 48V ACDC, 110V AC, 240V AC +/-10%

SMFR 9.3 LD 16Q A : 12V DC, 24V DC, 12V AC, 24V AC, 48V AC, 110V AC, 240V AC +/-10%

Caractéristiques mécaniques

Corps en ABS et dômes en PC. Joints dômes en PVC et couvercles postérieurs feux en Forprene. Equipé avec presse-étoupe M20.

Caractéristiques optiques

Groupe optique avec 16 LED carrées à haute définition optique. Les dômes permettent d'augmenter le faisceau lumineux à lumière fixe (lumière clignotante disponible sur demande).

Caractéristiques acoustiques

SMFR 9.3 LD 16Q A : buzzer acoustique. Son continu.
Fréquence : 650/50Hz

SMFR 9.2 LD 16Q



SMFR 9.2 LD 16Q

SMFR 9.2 LD 16Q A

Corpo / Body / Corps

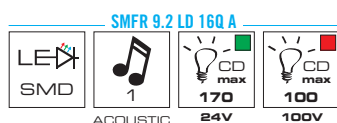
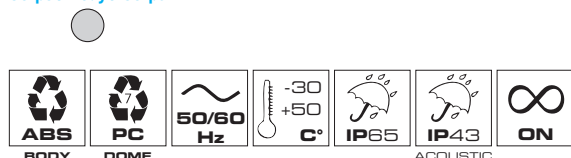

SMFR 9.2 LD 16Q

V DC	12	-	24	-	48	-	-	-
V AC	-	12	-	24	-	48	110	240
mA*	185	145	110	155	40	105	20	20

SMFR 9.2 LD 16Q A

V DC	12	-	24	-	-	-	-
V AC	-	12	-	24	48	110	240
mA*	185	145	110	155	105	20	20
dB(A)1m	90	80	90	90	90	90	90

* I dati di assorbimento si riferiscono ad una sola sezione luminosa
Power consumption data refer to one light source only
Les données de consommation se réfèrent à une seule section lumineuse

Codici / Codes

SMFR 9.2 LD 16Q

12V ACDC	69431
24V ACDC	69432
48V ACDC	69433
110V AC	69434
240V AC	69435

SMFR 9.2 LD 16Q A

12V DC	69579
24V DC	69580
12V AC	69461
24V AC	69462
48V AC	69463
110V AC	69464
240V AC	69465

Semaforo industriale a LED progettato per la segnalazione in diverse situazioni nell'ambito dell'ingegneria edile, meccanica e del controllo degli accessi.

I semafori **SMFR 9.2 LD 16Q** sono dotati di tecnologia LED a luce fissa (luce lampeggiante a richiesta) e sono disponibili anche con segnalazione acustica integrata **SMFR 9.2 LD 16Q A**.

Tensione operativa

SMFR 9.2 LD 16Q: 12V ACDC, 24V ACDC, 48V ACDC, 110V AC, 240V AC +/-10%

SMFR 9.2 LD 16Q A: 12V DC, 24V DC, 12V AC, 24V AC, 48V AC, 110V AC, 240V AC +/-10%

Caratteristiche meccaniche

Corpo in ABS e cupole in PC. Guarnizioni cupole in PVC e coperchio retro luci in Forprene. Dotato di pressacavo M20.

Caratteristiche luminose

Gruppo ottico costituito da 16 LED quadrati ad elevata definizione ottica. Le cupole appositamente studiate permettono di magnificare il fascio luminoso fisso (luce lampeggiante a richiesta).

Caratteristiche acustiche

SMFR 9.2 LD 16Q A: buzzer acustico. Suono continuo.

Frequenza: 650/50Hz

Certificazioni / Certifications

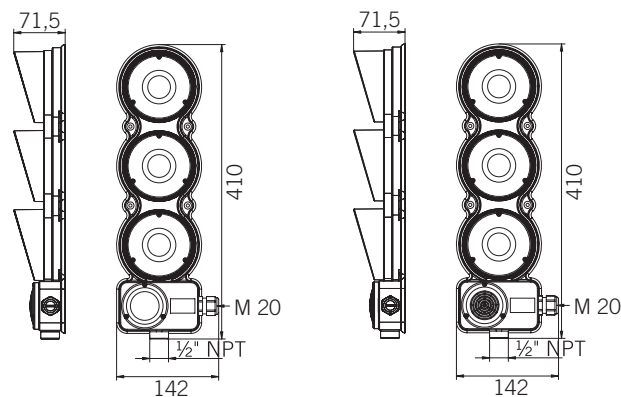

SMFR 9.2 LD 16Q



SMFR 9.2 LD 16Q A



LED industrial traffic light engineered for signalization in different scenarios like building technology, mechanical engineering and access control systems.

SMFR 9.2 LD 16Q traffic lights benefit from steady light LED technology (flashing light version on request). Version with integrated acoustic signalization **SMFR 9.2 LD 16Q A** also available.

Voltages

SMFR 9.2 LD 16Q: 12V ACDC, 24V ACDC, 48V ACDC, 110V AC, 240V AC +/-10%

SMFR 9.2 LD 16Q A: 12V DC, 24V DC, 12V AC, 24V AC, 48V AC, 110V AC, 240V AC +/-10%

Mechanical features

ABS body and PC domes. PVC dome gaskets and Forprene rear light covers. Equipped with M20 cable gland.

Optical features

Optical group made up of 16 square LEDs with high optical performance. Domes engineered to intensify the steady light beam (flashing light available on request).

Acoustic features

SMFR 9.2 LD 16Q A: acoustic buzzer. Continuous sound.
Frequency: 650/50Hz



Feu de signalisation industrielle à LED développé pour la signalisation dans différents domaines comme la technologie de construction, l'ingénierie mécanique et le contrôle d'accès.

Les feux de trafic **SMFR 9.2 LD 16Q** ont été développés avec une technologie LED à lumière fixe (lumière clignotante disponible sur demande) et sont disponibles avec signalisation acoustique intégrée **SMFR 9.2 LD 16Q A**.

Tension d'utilisation

SMFR 9.2 LD 16Q : 12V ACDC, 24V ACDC, 48V ACDC, 110V AC, 240V AC +/-10%

SMFR 9.2 LD 16Q A : 12V DC, 24V DC, 12V AC, 24V AC, 48V AC, 110V AC, 240V AC +/-10%

Caractéristiques mécaniques

Corps en ABS et dômes en PC. Joints dômes en PVC et couvercles postérieurs feux en Forprene. Equipé avec presse-étoupe M20.

Caractéristiques optiques

Groupe optique avec 16 LED carrées à haute définition optique. Les dômes permettent d'augmenter le faisceau lumineux à lumière fixe (lumière clignotante disponible sur demande).

Caractéristiques acoustiques

SMFR 9.2 LD 16Q A : buzzer acoustique. Son continu.
Fréquence : 650/50Hz

SMFR 12.3 LD 24Q



SMFR 12.3 LD 24Q

SMFR 12.3 LD 24Q A

Corpo / Body / Corps

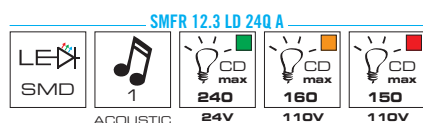
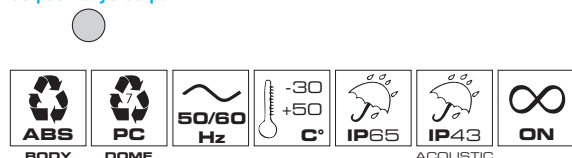

SMFR 12.3 LD 24Q							
V DC	12	-	24	-	48	-	-
V AC	-	12	-	24	-	48	110 240
mA*	280	230	105	155	60	135	20 20

SMFR 12.3 LD 24Q A							
V DC	12	-	24	-	-	-	-
V AC	-	12	-	24	48	110	240
mA*	280	230	105	155	135	20	20
dB(A)1m	90	80	90	90	90	90	90

* I dati di assorbimento si riferiscono ad una sola sezione luminosa
Power consumption data refer to one light source only
Les données de consommation se réfèrent à une seule section lumineuse

Codici / Codes

SMFR 12.3 LD 24Q

	●●●●
12V ACDC	69421
24V ACDC	69422
48V ACDC	69423
110V AC	69424
240V AC	69425

SMFR 12.3 LD 24Q A

	●●●●
12V DC	69574
24V DC	69575
12V AC	69451
24V AC	69452
48V AC	69453
110V AC	69454
240V AC	69455

Semaforo industriale a LED progettato per la segnalazione in diverse situazioni nell'ambito dell'ingegneria edile, meccanica e del controllo degli accessi.

I semafori **SMFR 12.3 LD 24Q** sono dotati di tecnologia LED a luce fissa (luce lampeggiante a richiesta) e sono disponibili anche con segnalazione acustica integrata **SMFR 12.3 LD 24Q A**.

Tensione operativa

SMFR 12.3 LD 24Q: 12V ACDC, 24V ACDC, 48V ACDC, 110V AC, 240V AC +/-10%

SMFR 12.3 LD 24Q A: 12V DC, 24V DC, 12V AC, 24V AC, 48V AC, 110V AC, 240V AC +/-10%

Caratteristiche meccaniche

Corpo in ABS e cupole in PC. Guarnizioni cupole in PVC e coperchio retro luci in Forprene. Dotato di pressacavo M20.

Caratteristiche luminose

Gruppo ottico costituito da 24 LED quadrati ad elevata definizione ottica. Le cupole appositamente studiate permettono di magnificare il fascio luminoso fisso (luce lampeggiante a richiesta).

Caratteristiche acustiche

SMFR 12.3 LD 24Q A: buzzer acustico. Suono continuo.

Frequenza: 650/50Hz

Certificazioni / Certifications

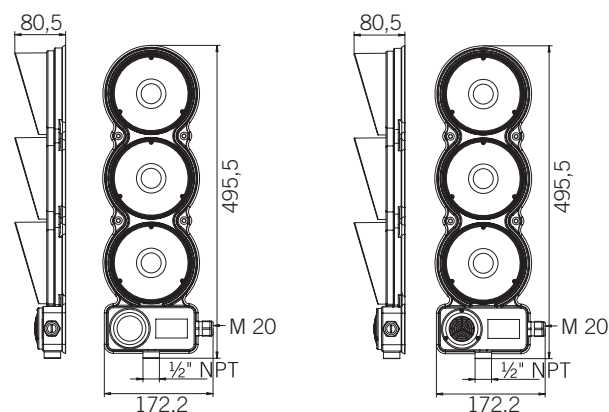

SMFR 12.3 LD 24Q



SMFR 12.3 LD 24Q A



LED industrial traffic light engineered for signalization in different scenarios like building technology, mechanical engineering and access control systems.

SMFR 12.3 LD 24Q traffic lights benefit from steady light LED technology (flashing light version on request). Version with integrated acoustic signalization **SMFR 12.3 LD 24Q A** also available.

Voltages

SMFR 12.3 LD 24Q: 12V ACDC, 24V ACDC, 48V ACDC, 110V AC, 240V AC +/-10%

SMFR 12.3 LD 24Q A: 12V DC, 24V DC, 12V AC, 24V AC, 48V AC, 110V AC, 240V AC +/-10%

Mechanical features

ABS body and PC domes. PVC dome gaskets and Forprene rear light covers. Equipped with M20 cable gland.

Optical features

Optical group made up of 24 square LEDs with high optical performance. Domes engineered to intensify the steady light beam (flashing light available on request).

Acoustic features

SMFR 12.3 LD 24Q A: acoustic buzzer. Continuous sound. Frequency: 650/50Hz



Feu de signalisation industrielle à LED développé pour la signalisation dans différents domaines comme la technologie de construction, l'ingénierie mécanique et le contrôle d'accès.

Les feux de trafic **SMFR 12.3 LD 24Q** ont été développés avec une technologie LED à lumière fixe (lumière clignotante disponible sur demande) et sont disponibles avec signalisation acoustique intégrée **SMFR 12.3 LD 24Q A**.

Tension d'utilisation

SMFR 12.3 LD 24Q: 12V ACDC, 24V ACDC, 48V ACDC, 110V AC, 240V AC +/-10%

SMFR 12.3 LD 24Q A: 12V DC, 24V DC, 12V AC, 24V AC, 48V AC, 110V AC, 240V AC +/-10%

Caractéristiques mécaniques

Corps en ABS et dômes en PC. Joints dômes en PVC et couvercles postérieurs feux en Forprene. Equipé avec presse-étoupe M20.

Caractéristiques optiques

Groupe optique avec 24 LED carrées à haute définition optique. Les dômes permettent d'augmenter le faisceau lumineux à lumière fixe (lumière clignotante disponible sur demande).

Caractéristiques acoustiques

SMFR 12.3 LD 24Q A: buzzer acoustique. Son continu. Fréquence : 650/50Hz

SMFR 12.2 LD 24Q



SMFR 12.2 LD 24Q

SMFR 12.2 LD 24Q A

Corpo / Body / Corps

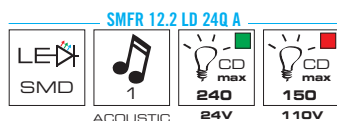
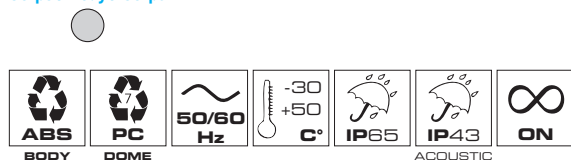

SMFR 12.2 LD 24Q

V DC	12	-	24	-	48	-	-	-
V AC	-	12	-	24	-	48	110	240
mA*	280	230	105	155	60	135	20	20

SMFR 12.2 LD 24Q A

V DC	12	-	24	-	-	-	-	-
V AC	-	12	-	24	48	110	240	
mA*	280	230	105	155	135	20	20	
dB(A)1m	90	80	90	90	90	90	90	

* I dati di assorbimento si riferiscono ad una sola sezione luminosa
Power consumption data refer to one light source only
Les données de consommation se réfèrent à une seule section lumineuse

Codici / Codes

SMFR 12.2 LD 24Q

12V ACDC	69436
24V ACDC	69437
48V ACDC	69438
110V AC	69439
240V AC	69440

SMFR 12.2 LD 24Q A

12V DC	69584
24V DC	69585
12V AC	69466
24V AC	69467
48V AC	69468
110V AC	69469
240V AC	69470

Semaforo industriale a LED progettato per la segnalazione in diverse situazioni nell'ambito dell'ingegneria edile, meccanica e del controllo degli accessi.

I semafori **SMFR 12.2 LD 24Q** sono dotati di tecnologia LED a luce fissa (luce lampeggiante a richiesta) e sono disponibili anche con segnalazione acustica integrata **SMFR 12.2 LD 24Q A**.

Tensione operativa

SMFR 12.2 LD 24Q: 12V ACDC, 24V ACDC, 48V ACDC, 110V AC, 240V AC +/-10%

SMFR 12.2 LD 24Q A: 12V DC, 24V DC, 12V AC, 24V AC, 48V AC, 110V AC, 240V AC +/-10%

Caratteristiche meccaniche

Corpo in ABS e cupole in PC. Guarnizioni cupole in PVC e coperchio retro luci in Forprene. Dotato di pressacavo M20.

Caratteristiche luminose

Gruppo ottico costituito da 24 LED quadrati ad elevata definizione ottica. Le cupole appositamente studiate permettono di magnificare il fascio luminoso fisso (luce lampeggiante a richiesta).

Caratteristiche acustiche

SMFR 12.2 LD 24Q A: buzzer acustico. Suono continuo.

Frequenza: 650/50Hz

Certificazioni / Certifications

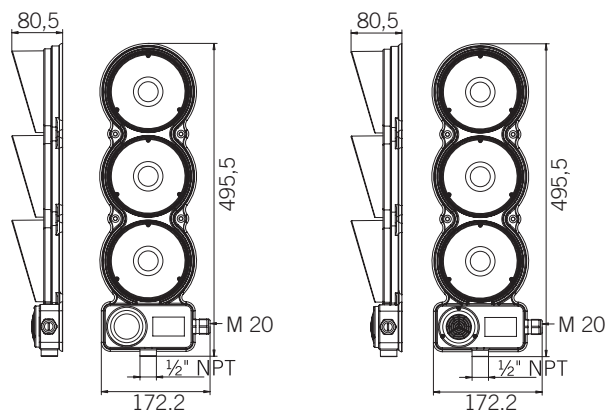

SMFR 12.2 LD 24Q



SMFR 12.2 LD 24Q A



LED industrial traffic light engineered for signalization in different scenarios like building technology, mechanical engineering and access control systems.

SMFR 12.2 LD 24Q traffic lights benefit from steady light LED technology (flashing light version on request). Version with integrated acoustic signalization **SMFR 12.2 LD 24Q A** also available.

Voltages

SMFR 12.2 LD 24Q: 12V ACDC, 24V ACDC, 48V ACDC, 110V AC, 240V AC +/-10%

SMFR 12.2 LD 24Q A: 12V DC, 24V DC, 12V AC, 24V AC, 48V AC, 110V AC, 240V AC +/-10%

Mechanical features

ABS body and PC domes. PVC dome gaskets and Forprene rear light covers. Equipped with M20 cable gland.

Optical features

Optical group made up of 24 square LEDs with high optical performance. Domes engineered to intensify the steady light beam (flashing light available on request).

Acoustic features

SMFR 12.2 LD 24Q A: acoustic buzzer. Continuous sound. Frequency: 650/50Hz



Feu de signalisation industrielle à LED développé pour la signalisation dans différents domaines comme la technologie de construction, l'ingénierie mécanique et le contrôle d'accès.

Les feux de trafic **SMFR 12.2 LD 24Q** ont été développés avec une technologie LED à lumière fixe (lumière clignotante disponible sur demande) et sont disponibles avec signalisation acoustique intégrée **SMFR 12.2 LD 24Q A**.

Tension d'utilisation

SMFR 12.2 LD 24Q: 12V ACDC, 24V ACDC, 48V ACDC, 110V AC, 240V AC +/-10%

SMFR 12.2 LD 24Q A: 12V DC, 24V DC, 12V AC, 24V AC, 48V AC, 110V AC, 240V AC +/-10%

Caractéristiques mécaniques

Corps en ABS et dômes en PC. Joints dômes en PVC et couvercles postérieurs feux en Forprene. Equipé avec presse-étoupe M20.

Caractéristiques optiques

Groupe optique avec 24 LED carrées à haute définition optique. Les dômes permettent d'augmenter le faisceau lumineux à lumière fixe (lumière clignotante disponible sur demande).

Caractéristiques acoustiques

SMFR 12.2 LD 24Q A: buzzer acoustique. Son continu. Fréquence : 650/50Hz

FEU LED 2.0



FEU LED 2.0 200

FEU LED 2.0 300

Corpo / Body / Corps

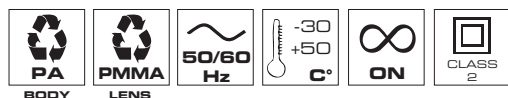

FEU LED 2.0 200



FEU LED 2.0 300

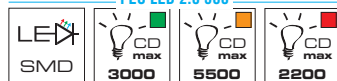

FEU LED 2.0 200

V AC	110	240
mA	60	50

FEU LED 2.0 300

V AC	110	240
mA	60	50

Codici / Codes

FEU LED 2.0 200

110/240V AC	35155	35153	35154
-------------	-------	-------	-------

FEU LED 2.0 300*

110/240V AC	35165	35163	35164
-------------	-------	-------	-------

* Si prega contattare il nostro Staff Commerciale
 * Please contact our Sales Department
 * Veuillez contacter notre Service Commercial

Lampade semaforiche a LED sviluppate per il retrofit di impianti tradizionali con lampade a incandescenza. Progettate per soddisfare i requisiti luminosi imposti dalla norma UNI EN 12368 "TRAFFIC CONTROL EQUIPMENT", i FEU LED 2.0 simulano il comportamento di una lampada tradizionale, consentendo ai sistemi di controllo e di feedback, calibrati su lampade a incandescenza, di lavorare correttamente, pur mantenendo le caratteristiche della tecnologia LED, quali lunga durata, alta resistenza alle vibrazioni e bassi consumi. Disponibili versioni FEU LED 2.0 200 (Ø 190) e FEU LED 2.0 300 (Ø 276).

Tensione operativa

110/240V AC +/-10%

Caratteristiche meccaniche

Corpo in PA e lente in metacrilato (PMMA). Alta resistenza agli impatti, alle vibrazioni, alla polvere e agli agenti atmosferici.

Caratteristiche luminose

4 LED compatti (5 per il colore rosso) ad alta intensità.

Certificazioni / Certifications

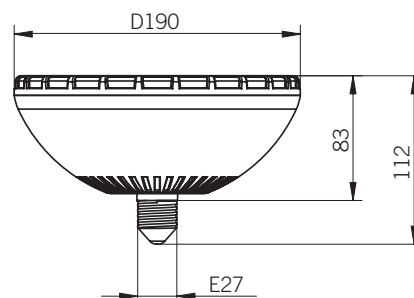

FEU LED 2.0 200

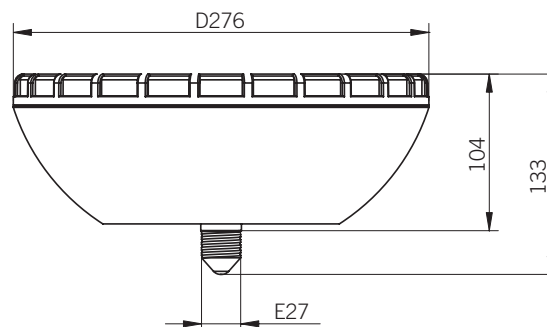

FEU LED 2.0 300



LED bulbs engineered for traditional traffic light retrofits. Engineered to conform to UNI EN 12368 "TRAFFIC CONTROL EQUIPMENT" requirements, FEU LED 2.0 bulbs behave like a traditional incandescent filament bulb whilst retaining the great advantages given by LEDs like long life, high vibrations resistance and low consumption.

Behaving like a traditional bulb is vital when retrofitting a traditional traffic light system as all control and feedback systems, calibrated and engineered to detect filament bulbs, keep on working normally.

Two versions available: FEU LED 2.0 200 (Ø 190) and FEU LED 2.0 300 (Ø 276).

Voltages

110/240V AC +/-10%

Mechanical features

PA body and methacrylate (PMMA) lens. Totally protected against vibrations, dust and atmospheric elements.

Optical features

4 compact LEDs (5 LEDs for red color) with high optical performance.



Ampoules à LED pour feu de signalisation, développées pour le retrofit des appareils traditionnels. Conformes aux exigences de luminosité prévues par la norme UNI EN 12368 "TRAFFIC CONTROL EQUIPMENT", les FEU LED 2.0 ressemblent à une ampoule à incandescence, même en apportant une série d'avantages, tels que longue durabilité, haute résistance aux vibrations et basse consommation énergétique.

Simuler le comportement d'une ampoule traditionnelle est important lors du retrofit, car les systèmes de contrôle et d'autorégulation, calibrés sur la base des ampoules à incandescence, peuvent distinguer correctement les ampoules à LED et leur fonctionnement. Disponibles en version FEU LED 2.0 200 (Ø 190) et FEU LED 2.0 300 (Ø 276).

Tension d'utilisation

110/240V AC +/-10%

Caractéristiques mécaniques

Corps en polyamide et lentille en PMMA. Totalemment protégé contre les vibrations, la poussière et les agents atmosphériques.

Caractéristiques optiques

4 LED compactes (5 pour la couleur rouge) à haute définition optique.

F4 LED



F4 LED

Corpo / Body / Corps



STEADY LIGHT



SEQUENTIAL LIGHT

F4 LED

V DC	24	-
V AC	-	24
mA*	25	100
mA**	130	310

*Luce fissa / Steady light / Lumière fixe

**Luce a scorrimento / Sequential light / Lumière à défilement

Codici / Codes

F4 LED

24V ACDC

21412 21413 21414

Dispositivo a LED progettato per la segnalazione direzionale in parcheggi e camminamenti. F4 LED è dotato di luce a scorrimento e fissa (bassa intensità).

Tensione operativa

24V ACDC +/-10%

Caratteristiche meccaniche

Corpo e cupola in PC. Alta resistenza agli impatti, alle vibrazioni, alla polvere e agli agenti atmosferici.

Caratteristiche luminose

Gruppo ottico costituito da 35 LED Superflux ad elevata definizione ottica che producono luce a scorrimento o fissa (a bassa intensità).

Certificazioni / Certifications

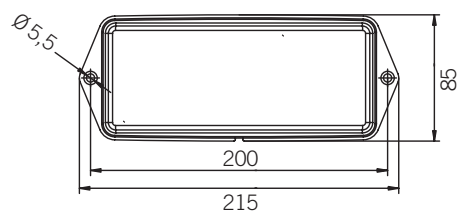
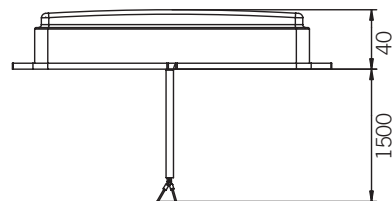

F4 LED



Directional signaling LED device engineered for parking and private paths. F4 LED provides sequential or steady (low intensity) light.

Voltages

24V ACDC +/-10%

Mechanical features

PC body and lens. Totally protected against vibrations, dust and atmospheric elements.

Optical features

35 Superflux LED with high optical performance producing sequential or steady (low intensity) light.



Dispositif de signalisation directionnelle à LED développé pour parkings et accès privés. F4 LED produit une lumière à défilement ou fixe (basse intensité).

Tension d'utilisation

24V ACDC +/-10%

Caractéristiques mécaniques

Corps et lentille en PC. Totalement protégé contre les vibrations, la poussière et les agents atmosphériques.

Caractéristiques optiques

35 LED Superflux à haute définition optique qui produisent une lumière à défilement ou fixe (basse intensité).

R4 LED



R4 LED



Corpo / Body / Corps



R4 LED

V DC	24	-
V AC	-	24
mA	90	140

Codici / Codes

R4 LED

24V ACDC			
	21416	21415	21417
24V ACDC			
	21419	21418	21420

Dispositivo di segnalazione a LED, sviluppato per la gestione del traffico nei punti di accesso. R4 LED dispone di due colorazioni del corpo (cromato e bianco) che consentono al dispositivo di confondersi con il design dei punti di accesso. Luce fissa.

Tensione operativa

24V ACDC +/-10%

Caratteristiche meccaniche

Corpo e lente in policarbonato. Alta resistenza agli impatti, alle vibrazioni, alla polvere e agli agenti atmosferici. Installazione retroquadro con 3 viti a testa svasata e connessione tramite cavo bipolare 500 mm.

Caratteristiche luminose

24 LED quadrati superflux ad alta intensità.

Certificazioni / Certifications

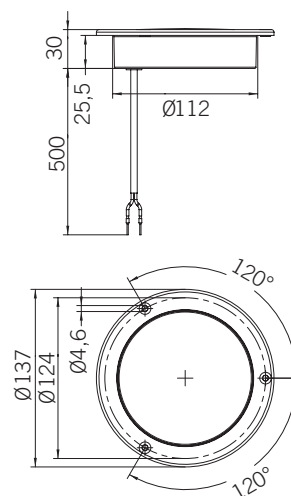

R4 LED



Priority signaling LED device engineered for gates and access points. R4 LED benefits from two body colors (chrome and white), allowing to blend with the design of the access point. Steady light.

Voltages

24V ACDC +/-10%

Mechanical features

PC body and lens. Totally protected against vibrations, dust and atmospheric elements. Designed to be flush mounted, it can be secured with 3 countersunk screws. Wiring through 500 mm bipolar cable.

Optical features

24 Superflux square LED with high optical performance.



Dispositif de signalisation à LED développé pour portes et points d'accès. R4 LED dispose de deux couleurs du corps (chromé et blanc), permettant au dispositif de se confondre avec le design des points d'accès. Lumière fixe.

Tension d'utilisation

24V ACDC +/-10%

Caractéristiques mécaniques

Corps et lentille en PC. Protégé contre les vibrations, la poussière et les agents atmosphériques. Installation à encastrer par 3 vis plates et connexion par câble bipolaire de 500 mm.

Caractéristiques optiques

24 LED carrées Superflux à haute définition optique.

T4 LED

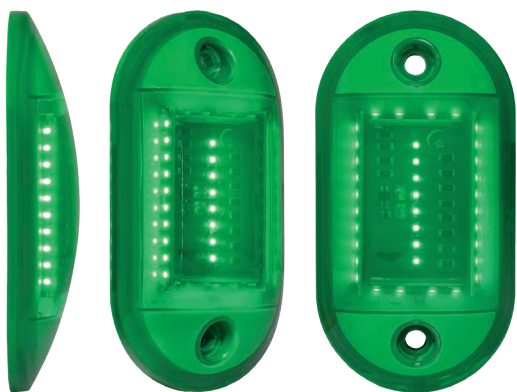

T4 LED

Corpo / Body / Corps



T4 LED

V DC	24	-
V AC	-	24
mA	120	160

Dispositivo a LED integrati, progettato per la segnalazione in diverse situazioni nell'ambito dell'ingegneria edile, meccanica e del controllo degli accessi.

T4 LED è dotato di luce fissa.

Tensione operativa

24V ACDC +/-10%

Caratteristiche meccaniche

Corpo/cupola in policarbonato autoestinguente V0. Alta resistenza agli impatti, alle vibrazioni, alla polvere e agli agenti atmosferici.

Caratteristiche luminose

Gruppo ottico costituito da 36 LED SMD ad elevata definizione ottica che producono luce fissa.

Certificazioni / Certifications

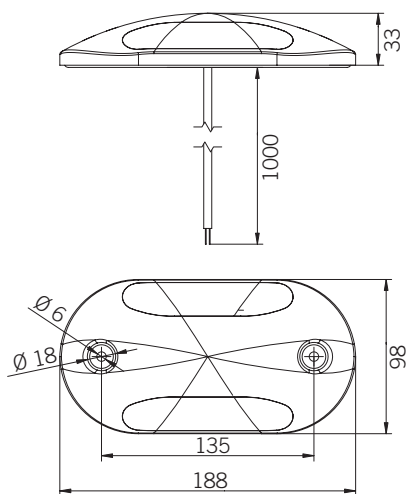

T4 LED



LED device engineered for signalization in different scenarios like building technology, mechanical engineering and access control systems. T4 LED provides steady light.

Voltages

24V ACDC +/-10%

Mechanical features

V0 self-extinguishing PC body/lens. Totally protected against vibrations, dust and atmospheric elements.

Optical features

Optical group made up of 36 LEDs with high optical performance.



Dispositif à LED intégrées développé pour la signalisation dans différents domaines comme la technologie de construction, l'ingénierie mécanique et le contrôle d'accès. T4 LED produit une lumière fixe.

Tension d'utilisation

24V ACDC +/-10%

Caractéristiques mécaniques

Corps/dôme en polycarbonate auto-extinguible V0. Totalement protégé contre les vibrations, la poussière et les agents atmosphériques.

Caractéristiques optiques

Groupe optique avec 36 LED à haute définition optique.

Codici / Codes

T4 LED*

24V ACDC

21408

* Per altri colori, si prega contattare il nostro Staff Commerciale

* Other colors, please contact our Sales Department

* Pour d'autres couleurs veuillez contacter notre Service Commercial



WORKPLUS

Dispositivi di segnalazione per veicoli da lavoro
Signaling devices for workplace vehicles
Dispositifs de signalisation pour véhicules de travail



SIRENA



188 **Introduzione** **Introduction** **Introduction**

190 **Dispositivi luminosi e acustici per veicoli da lavoro aziendali** **Luminous and acoustic devices for workplace vehicles** **Dispositifs de signalisation pour véhicules de travail**

190	INDICATOR
191	LWX
192	ROTATOR LED
193	ROTATOR
194	LWL 15W 5LED
195	LWL 15W 9LED
196	LWL 18W 6LED
197	LWL 21W 14LED
198	T PLUS
199	FORK PLUS
200	INDIGO
201	LWL REV 18W 6LED
202	REVERSER



204 **Accessori per dispositivi luminosi** **Accessories for luminous devices** **Accessoires pour dispositifs lumineux**

204	Spinotti / Adapter sockets / Prises de connexion
205	Prolunghe / Extension poles / Rallonges



206 **Certificazioni e Normative** **Certifications and Normatives** **Certifications et Normes**

INTRODUZIONE

La gestione quotidiana delle attività di manutenzione e la movimentazione dei materiali e delle merci all'interno dei siti industriali è un aspetto sempre più importante nelle aziende moderne. La sicurezza di tali operazioni costituisce un aspetto fondamentale, considerata la serie di pericoli e rischi correlati alla viabilità dei mezzi utilizzati nel perimetro aziendale.

Da sempre Sirena rappresenta un punto di riferimento quando la sicurezza costituisce una priorità, mettendo a disposizione del personale operativo un'ampia gamma di prodotti, con la quale garantisce la massima efficienza di segnalazione, allertamento e illuminazione per i veicoli che operano nel perimetro aziendale.

Con **WORKPLUS** Sirena offre una gamma completa di dispositivi per la segnalazione e l'illuminazione:

- Barre luminose con tecnologia a LED
- Luci di Sicurezza con sorgente luminosa a LED (per effetto luminoso rotante o flash ad elevata intensità) o con lampada alogena
- Fari da Lavoro con tecnologia a LED
- Torcia a LED con fascio luminoso regolabile
- Dispositivi Luminosi e Acustici sviluppati espressamente per la sicurezza operativa dei carrelli elevatori





INTRODUCTION

Managing all day-to-day maintenance and material handling activities has become an important part in modern facilities. Safety in these operation activities is a key issue, considering the wide range of hazards and risks associated with workplace transport.

Since many years, Sirena represents a point of reference when safety is a priority, providing factory personnel with an extensive choice of products, ensuring an intensive warning, signaling and lighting effectiveness for their workplace vehicles.

With **WORKPLUS** Sirena offers a complete range of signaling and lighting devices:

- Light bars with LED technology
- Safety Beacons with LED source (producing a high intensity rotating or flashing effect) or with halogen bulb
- Work Beams with LED technology
- LED Torch with adjustable focus range
- Safety Luminous and Acoustic devices especially engineered for forklift operations



INTRODUCTION

Gérer quotidiennement des activités de maintenance et de manutention est commun dans les installations modernes. Les zones de travail présentent de nombreux risques et dangers, assurer la sécurité des opérateurs dans ces lieux est nécessaire.

Depuis des années, avec sa large offre de dispositifs assurant l'avertissement et la signalisation dans les zones de travail, Sirena offre ses solutions partout où la sécurité est une priorité.

Avec **WORKPLUS** Sirena offre une gamme complète de dispositifs de signalisation :

- Rampes lumineuses à LED
- Feux à LED (rotatif et flash) et halogène
- Phares de travail à LED
- Torche à LED avec faisceau ajustable
- Dispositifs lumineux et acoustiques pour chariots élévateurs



INDICATOR



INDICATOR 9



INDICATOR 7



Moduli a LED superluminosi
Very bright LED modules
Modules à LED très lumineux



Telecomando
Control unit
Télécommande

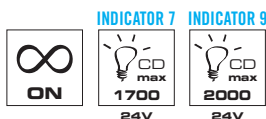
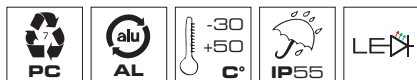

INDICATOR 7		INDICATOR 9	
V DC	12 ÷ 24	V DC	12 ÷ 24
A	2,7 1,35	A	3,5 1,8

Barra multifunzionale dal design compatto sviluppata per il controllo del traffico. **INDICATOR** è disponibile in versione a sette o nove moduli a LED. Offre performance ottiche eccellenti e versatilità nell'installazione. Funzioni di lampeggio selezionate e simulate attraverso il telecomando.

Tensione operativa
12/24V DC +/-10%

Caratteristiche meccaniche
Struttura realizzata con profili in alluminio e lenti in policarbonato.

Caratteristiche luminose
Moduli a 3 LED a elevata luminosità. Consentono sei diverse funzioni di lampeggio: Flash Singolo (1F), Doppio Flash (2F), Alternato Centrali/Laterali, Centro/Estremità, Sinistra/Destra, Destra/Sinistra

Certificazioni / Certifications



EMC UNECE 10R

E3 04 1234 (12/24V)



INDICATOR 7

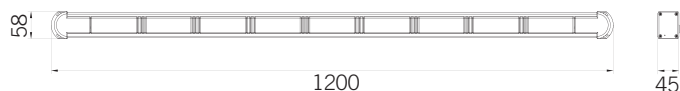

INDICATOR 9



Compact size multifunctional light bar for traffic control operations. Available with seven or nine LED modules, **INDICATOR** offers excellent optical performance as well as installation versatility. Flashing patterns are selected and simulated via control unit.

Voltages
12/24V DC +/-10%

Mechanical features
Structure made up of aluminum profiles and polycarbonate lenses.

Optical features
Powerful 3 LED modules allowing six different flashing patterns: Single Flash (1F), Double Flash (2F), Alternating Central/Lateral, Centre/Extremity, Left/Right, Right/Left



Rampe multifonction avec design compact conçue pour les opérations de contrôle de la circulation. Disponible avec sept ou neuf modules LED, **INDICATOR** offre une excellente performance optique ainsi qu'une excellente flexibilité d'installation. Les fonctions de clignotement sont sélectionnées et simulées par la télécommande.

Tension d'alimentation
12/24V DC +/-10%

Caractéristiques mécaniques
Structure en profilé d'aluminium et lentilles en polycarbonate.

Caractéristiques optiques
Modules avec 3 LED à haute luminosité. Six différents types de clignotement : Simple Éclat (1F), Double Éclat (2F), Alterné Centrales/laterales, Centre/Extrémités, Gauche/Droite, Droite/Gauche

Codici / Codes

INDICATOR

12/24V

INDICATOR 7
74907

INDICATOR 9
74908

LWX



LWX R B
LWX F B
ISO B1 (base piana / flat base / base plate)



LWX R		LWX F	
V DC	12 ÷ 24	V DC	12 ÷ 24
A	0,9 0,45	A	1,7 0,8

Intensità luminosa secondo **ECE R65**
Light intensity according to **ECE R65**
Intensité lumineuse conforme à la norme **ECE R65**

Disponibile anche / Also available / Disponible aussi



Codici / Codes

LWX

	LWX R EFFETTO ROTANTE ROTATING EFFECT EFFET TOURNANT	LWX F EFFETTO FLASH FLASHING EFFECT EFFET FLASH
	12/24V	12/24V

B	36556	36559
A	36557	36660
FLEXI	36479	36480
POLE	36477	36478
MAGNETIC	36558	36661

Luci di segnalazione omologate, sviluppate con tecnologia LED. Sono disponibili con effetto rotante **LWX R** o con effetto flash **LWX F**.
Progettate per sincronizzare più segnalatori (versioni con base ISO B1) accessi contemporaneamente (max. 8 articoli).

Tensione operativa
12/24V DC +/-10%

Caratteristiche meccaniche

Cupola in policarbonato infrangibile ad elevata resistenza agli impatti.
LWX B, LWX A, LWX POLE: base in alluminio (secondo ISO 4148, tipo B1 I tipo A I tipo C).
LWX MAGNETIC: base magnetica con cavo spiralato e spina accendisigari.
LWX FLEXI: base flessibile in gomma termoplastica resistente alle vibrazioni e agli shock.

Caratteristiche luminose

Gruppo ottico costituito da 8 LED che garantiscono un effetto rotante (**LWX R**) o flash (**LWX F**) ad elevata intensità.

Certificazioni / Certifications

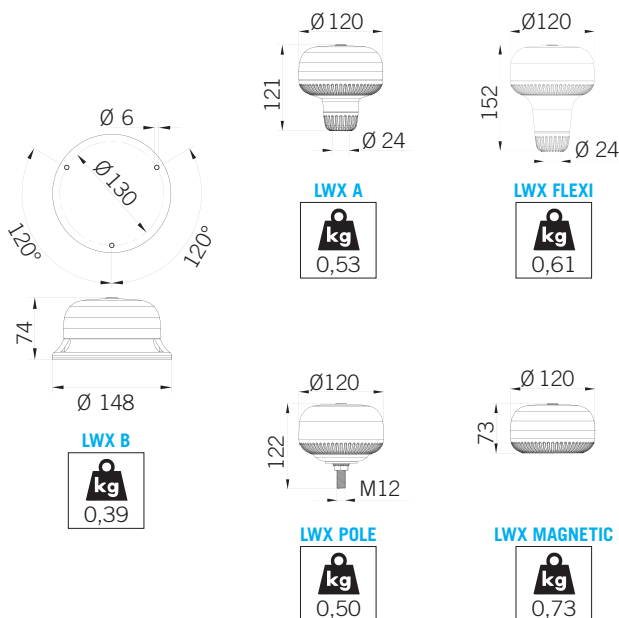

Approved beacons developed with LED light source. Available with rotating **LWX R** or flashing effect **LWX F**.
Engineered to synchronize more devices (ISO B1 base versions) switched on simultaneously (max. 8 devices).

Voltages
12/24V DC +/-10%

Mechanical features

Unbreakable polycarbonate dome allowing high impact resistance.
LWX B, LWX A, LWX POLE: aluminum base (according to ISO 4148, standard form B1 I form A I form C).
LWX MAGNETIC: magnetic base, helix cable and cigarette lighter plug.
LWX FLEXI: flexible thermoplastic base especially resistant to vibrations and shocks.

Optical features

Optical group made up of 8 LEDs allowing a high intensity rotating (**LWX R**) or flashing effect (**LWX F**).



Feux de signalisation homologués, développés avec source lumineuse LED. Les feux sont disponibles avec un effet tournant **LWX R** ou flash **LWX F**. La version base à fixation 3 points est conçue pour être synchronisée (max. 8 feux).

Tension d'alimentation
12/24V DC +/-10%

Caractéristiques mécaniques

Dôme en polycarbonate résistant aux chocs.
LWX B, LWX A, LWX POLE : base en aluminium (selon la norme ISO 4148, forme B1 I forme A I forme C).
LWX MAGNETIC : base magnétique, câble spiralé, fiche pour allume-cigare.
LWX FLEXI : base flexible en élastomère résistante aux vibrations et aux chocs.

Caractéristiques optiques

Groupe optique constitué par 8 LED qui permet un effet tournant (**LWX R**) ou flash (**LWX F**) à haute intensité.

ROTATOR LED



ROTATOR LED FLEXI
BASE FLESSIBILE ISO A (fissaggio su spinotto)
FLEXIBLE ISO A BASE (mount on adapter socket)
BASE FLEXIBLE ISO A (emboîtement sur prises de connexion)



ROTATOR LED

V DC	12 ÷ 24	Intensità luminosa secondo ECE R65 Light intensity according to ECE R65
A	2,5 1,0	Intensité lumineuse conforme à la norme ECE R65

Disponibile anche / Also available / Disponible aussi



ROTATOR LED B
BASE ISO B1 (base piana)
ISO B1 BASE (flat base)
BASE ISO B1 (base plate)



ROTATOR LED A
BASE ISO A (fissaggio su spinotto)
ISO A BASE (mount on adapter socket)
BASE ISO A (emboîtement sur prises de connexion)



ROTATOR LED POLE
BASE ISO C (fissaggio tramite bullone singolo M12)
ISO C BASE (M12 single bolt fixing base)
BASE ISO C (par boulon simple M12)



ROTATOR LED MAGNETIC
(Base magnetica, cavo spiralato e spina accendisigari)
(Magnetic base, helix cable and cigarette lighter plug)
(Base magnétique, câble spiralé et fiche pour allume-cigare)



ROTATOR LED MV
(Base magnetica, ventosa, cavo spiralato e spina accendisigari)
(Magnetic base, suction pad, helix cable and cigarette lighter plug)
(Base magnétique, ventouse, câble spiralé et fiche pour allume-cigare)

Codici / Codes

ROTATOR LED



B	90960
A	90961
FLEXI	90965
POLE	90962
MAGNETIC	90963
MV	90964

Luci di segnalazione omologate, sviluppate con tecnologia LED ad effetto flash. **ROTATOR LED** garantisce performance ottiche eccellenti e basso consumo.

Tensione operativa
 12/24V DC +/-10%

Caratteristiche meccaniche

Cupola avvitata in policarbonato infrangibile a elevata resistenza agli impatti.
ROTATOR LED: basi in poliammide rinforzato fibra di vetro.

ROTATOR LED FLEXI: base flessibile in EPDM resistente alle vibrazioni e agli shock.

Caratteristiche luminose

Gruppo ottico costituito da 6 LED che garantiscono un effetto flash ad elevata intensità, potenziato dal riflettore metallizzato.

Certificazioni / Certifications



ECE R65
EMC UNECE 10R

TA1 E3 00 7204
 E3 05 1248 (12/24V)

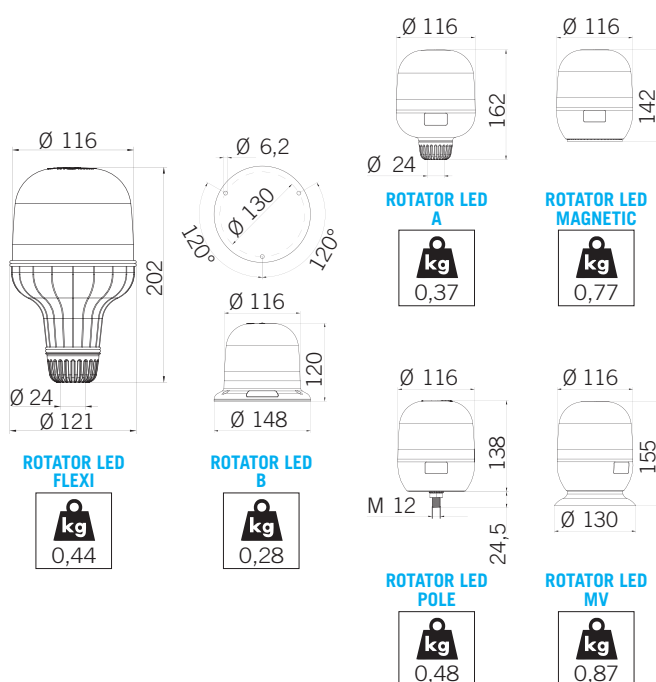

Approved beacons developed with LED light source, flashing effect. **ROTATOR LED** offers outstanding performances together with low power consumption.

Voltages
 12/24V DC +/-10%

Mechanical features

Unbreakable polycarbonate dome (screw in mount) allowing high impact resistance.

ROTATOR LED: fibreglass reinforced polyamide bases.

ROTATOR LED FLEXI: flexible EPDM base especially resistant to vibrations and shocks.

Optical features

Optical group made up of 6 LEDs allowing a high intensity flashing effect, enhanced by the metallized reflector.



Feux de signalisation homologués, développés avec source lumineuse LED à effet flash. **ROTATOR LED** offre haute performance optique ainsi que basse consommation d'énergie.

Tension d'alimentation
 12/24V DC +/-10%

Caractéristiques mécaniques

Dôme en polycarbonate incassable (fixation par vissage) résistant aux chocs.

ROTATOR LED: bases en polyamide renforcé fibre de verre.

ROTATOR LED FLEXI: base flexible en EPDM résistante aux vibrations et aux chocs.

Caractéristiques optiques

Groupe optique constitué par 6 LED qui permet un effet flash à haute intensité, amplifié par le réflecteur métallisé.

ROTATOR



ROTATOR FLEXI
BASE FLESSIBILE ISO A (fissaggio su spinotto)
FLEXIBLE ISO A BASE (mount on adapter socket)
BASE FLEXIBLE ISO A (emboîtement sur prises de connexion)

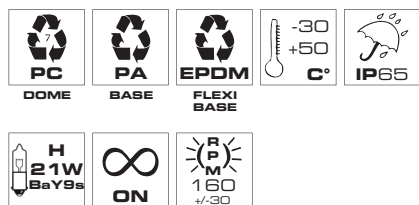

ROTATOR		
V DC	12 24	Intensità luminosa secondo ECE R65 Light intensity according to ECE R65
A	1,8 1,0	Intensité lumineuse conforme à la norme ECE R65

Disponibile anche / Also available / Disponible aussi

- 

ROTATOR B
 BASE ISO B1 (base piana)
 ISO B1 BASE (flat base)
 BASE ISO B1 (base plate)
- 

ROTATOR A
 BASE ISO A (fissaggio su spinotto)
 ISO A BASE (mount on adapter socket)
 BASE ISO A (emboîtement sur prises de connexion)
- 

ROTATOR POLE
 BASE ISO C (fissaggio tramite bullone singolo M12)
 ISO C BASE (M12 single bolt fixing base)
 BASE ISO C (par boulon simple M12)
- 

ROTATOR MAGNETIC
 (Base magnetica, cavo spiralato e spina accendisigari)
 (Magnetic base, helix cable and cigarette lighter plug)
 (Base magnétique, câble spiralé et fiche pour allume-cigare)
- 

ROTATOR MV
 (Base magnetica, ventosa, cavo spiralato e spina accendisigari)
 (Magnetic base, suction pad, helix cable and cigarette lighter plug)
 (Base magnétique, ventouse, câble spiralé et fiche pour allume-cigare)

Codici / Codes

ROTATOR

(fornito con lampada / Supplied with bulb / Fourni avec ampoule)

LUCE ROTANTE ROTATING BEACON FEU TOURNANT	12V	24V
B	90162	90163
A	90164	90165
FLEXI	90160	90161
POLE	90145	90146
MAGNETIC	90166	90167
MV	90176	90177

B	90162	90163
A	90164	90165
FLEXI	90160	90161
POLE	90145	90146
MAGNETIC	90166	90167
MV	90176	90177

Luci di segnalazione omologate, sviluppate con sorgente luminosa alogena H21W. **ROTATOR** garantisce performance ottiche eccellenti e consumi ridotti.

Tensione operativa

12V DC +/-10%
 24V DC +/-10%

Caratteristiche meccaniche

Cupola avvitata in policarbonato infrangibile ad elevata resistenza agli impatti.
ROTATOR: basi in poliammide rinforzato fibra di vetro.
ROTATOR FLEXI: base flessibile in EPDM resistente alle vibrazioni e agli shock.
 Trasmissione a cinghia estremamente silenziosa
 Rotazione su cuscinetto a sfere
 Filtro antiradiodisturbo integrato nel motore

Caratteristiche luminose

Specchio in policarbonato metallizzato.
 Sorgente luminosa alogena H21W.

Certificazioni / Certifications



ECE R65
EMC UNECE 10R
EMC UNECE 10R

TA1 E3 00 7141
 E3 03 1207 (12V)
 E3 03 1207 (24V)

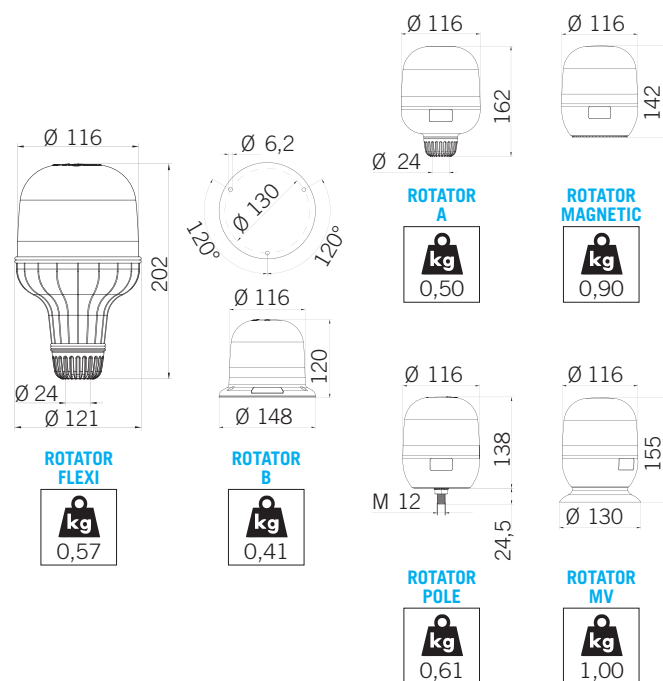

Approved rotating beacons developed with halogen light source H21W. **ROTATOR** offers outstanding performances together with low power consumption.

Voltagés

12V DC +/-10%
 24V DC +/-10%

Mechanical features

Unbreakable polycarbonate dome (screw in mount) allowing high impact resistance.
ROTATOR: fibreglass reinforced polyamide bases.
ROTATOR FLEXI: flexible EPDM base especially resistant to vibrations and shocks.
 Ultra silent drive belt technology
 Rotation through ball bearing
 Radio interference filter integrated in the motor

Optical features

Metallized polycarbonate reflector. Halogen light source H21W.



Feux tournants homologués, développés avec source lumineuse halogène H21W. **ROTATOR** offre haute performance optique ainsi que basse consommation d'énergie.

Tension d'alimentation

12V DC +/-10%
 24V DC +/-10%

Caractéristiques mécaniques

Dôme en polycarbonate incassable (fixation par vissage) résistant aux chocs.
ROTATOR : bases en polyamide renforcé fibre de verre.
ROTATOR FLEXI : base flexible en EPDM résistante aux vibrations et aux chocs.
 Entraînement par courroie, ultra silencieuse
 Rotation sur roulement à billes
 Filtre antiparasite intégré dans le moteur

Caractéristiques optiques

Réflecteur en polycarbonate métallisé. Source lumineuse halogène H21W.

LWL 15W 5LED



LWL 15W 5LED

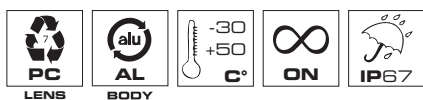

LWL 15W 5LED

V DC	12	24
A	1,0	0,55

In dotazione
Supplied with
Fourni avec

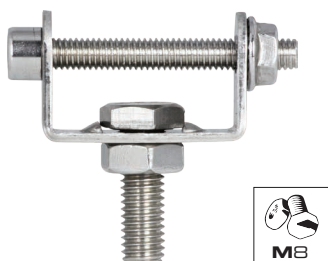

STAFFA DI FISSAGGIO
MOUNTING BRACKET
BRIDE DE FIXATION



Faro da lavoro a LED adatto all'utilizzo professionale per illuminazione su veicoli. I LED di tipo Epistar consentono l'utilizzo del dispositivo **LWL 15W 5LED** per almeno 30000 ore di lavoro, annullando i costi di manutenzione e garantendo un risparmio energetico.

Tensione operativa

10/30V DC +/-10%

Caratteristiche meccaniche

Lente in policarbonato e corpo in alluminio pressofuso.
Staffa di fissaggio in acciaio galvanizzato fornita.

Caratteristiche luminose

5x LED Epistar 3W ad alta luminosità.
Temperatura di colore 6000K.

Certificazioni / Certifications

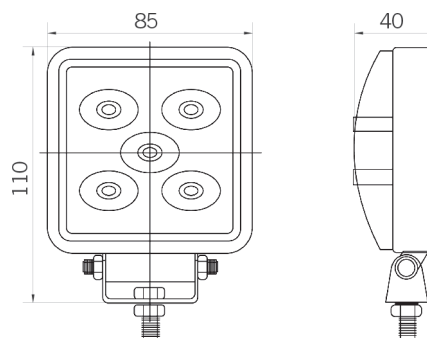

LWL 15W 5LED



LED work lamp ideal for professional vehicle lighting applications. The super bright Epistar LEDs allow using the device **LWL 15W 5LED** for over 30000 hours drastically reducing maintenance costs and enhancing energy savings.

Voltages

10/30V DC +/-10%

Mechanical features

Polycarbonate lens with diecast aluminum body.
Galvanized steel mounting bracket supplied.

Optical features

5x 3W super bright Epistar LEDs. Color temperature 6000K.



Phare de travail à LED adapté à l'éclairage professionnel pour véhicules. Les LED Epistar garantissent plus de 30000 heures de fonctionnement du dispositif **LWL 15W 5LED**, un entretien quasi-nul et elles permettent de moins consommer d'énergie.

Tension d'alimentation

10/30V DC +/-10%

Caractéristiques mécaniques

Optique en polycarbonate et boîtier en aluminium moulé sous pression. Bride de fixation en acier galvanisé fournie avec le produit.

Caractéristiques optiques

5x LED Epistar 3W haute luminosité. Température de couleur 6000K.

Codici / Codes

LED WORK LAMP 15W 5LED

10/30V DC

44001

LWL 15W 9LED



LWL 15W 9LED



LWL 15W 9LED

V DC	12	24
A	1,60	0,72

**In dotazione
Supplied with
Fourni avec**

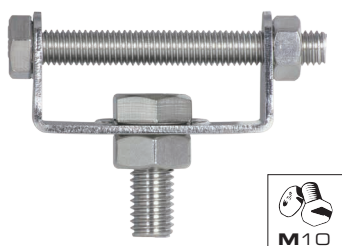

**STAFFA DI FISSAGGIO
MOUNTING BRACKET
BRIDE DE FIXATION**



Codici / Codes

LED WORK LAMP 15W 9LED

10/30V DC

44005

Faro da lavoro a LED adatto all'utilizzo professionale per illuminazione su veicoli. I LED di tipo Osram consentono l'utilizzo del dispositivo **LWL 15W 9LED** per almeno 30000 ore di lavoro annullando i costi di manutenzione e garantendo un risparmio energetico.

Tensione operativa
10/30V DC +/-10%

Caratteristiche meccaniche
Lente in policarbonato e corpo in alluminio pressofuso.
Staffa di fissaggio in acciaio inossidabile fornita.
Fissaggio tramite vite M10.

Caratteristiche ottiche
9x LED Osram ad alta luminosità.
Temperatura di colore 6000K.
Fascio luminoso 60°.

Certificazioni / Certifications



E50 10R-050076

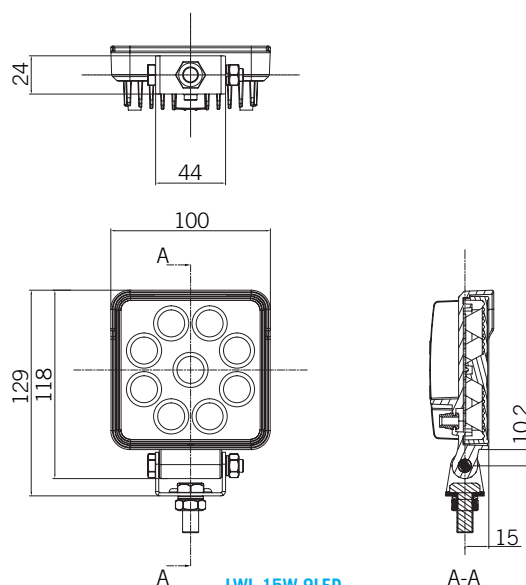

LWL 15W 9LED



LED work lamp ideal for professional vehicle lighting applications. The super bright Osram LEDs allow using the device **LWL 15W 9LED** for over 30000 hours drastically reducing maintenance costs and enhancing energy savings.

Voltage
10/30V DC +/-10%

Mechanical features
Polycarbonate lens with diecast aluminum body. Stainless steel mounting bracket supplied. Fixing through screw M10.

Optical features
9x super bright Osram LEDs.
Color temperature 6000K.
Light beam 60°.



Phare de travail à LED haute puissance adapté à l'éclairage professionnel pour véhicules. Les LED Osram du phare **LWL 15W 9LED** garantissent plus de 30000 heures de fonctionnement, un entretien quasi-nul et elles permettent de moins consommer d'énergie.

Tension d'alimentation
10/30V DC +/-10%

Caractéristiques mécaniques
Optique en polycarbonate et boîtier en aluminium moulé sous pression. Bride de fixation en acier inoxydable fournie avec le produit. Fixation par vis M10.

Caractéristiques optiques
9x LED Osram haute luminosité.
Température de couleur 6000K.
Faisceau lumineux 60°.

LWL 18W 6LED



LWL 18W 6LED

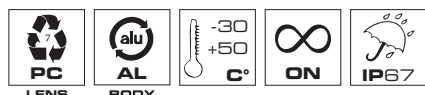

LWL 18W 6LED

V DC	12	24
A	1,4	0,75

In dotazione
Supplied with
Fourni avec



STAFFA DI FISSAGGIO
MOUNTING BRACKET
BRIDE DE FIXATION



Faro da lavoro a LED adatto all'utilizzo professionale per illuminazione su veicoli. I LED di tipo Epistar consentono l'utilizzo del dispositivo **LWL 18W 6LED** per almeno 30000 ore di lavoro, annullando i costi di manutenzione e garantendo un risparmio energetico.

Tensione operativa

10/30V DC +/-10%

Caratteristiche meccaniche

Lente in policarbonato e corpo in alluminio pressofuso.

La staffa di fissaggio in alluminio fornita consente l'installazione del faro orientandolo sui 180°.

Caratteristiche luminose

6x LED Epistar 3W ad alta luminosità.

Temperatura di colore 6000K.

Fascio luminoso 25°

Certificazioni / Certifications

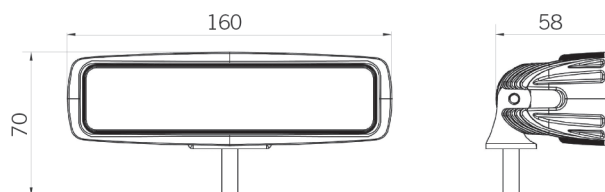

LWL 18W 6LED



LED work lamp ideal for professional vehicle lighting applications. The super bright Epistar LEDs allow using the device **LWL 18W 6LED** for over 30000 hours drastically reducing maintenance costs and enhancing energy savings.

Voltages

10/30V DC +/-10%

Mechanical features

Polycarbonate lens with diecast aluminum body. Adjustable (over 180°) aluminum mounting bracket supplied.

Optical features

6x 3W super bright Epistar LEDs. Color temperature 6000K. Light beam 25°.



Phare de travail à LED adapté à l'éclairage professionnel pour véhicules. Les LED Epistar garantissent plus de 30000 heures de fonctionnement du dispositif **LWL 18W 6LED**, un entretien quasi-nul et elles permettent de moins consommer d'énergie.

Tension d'alimentation

10/30V DC +/-10%

Caractéristiques mécaniques

Optique en polycarbonate et boîtier en aluminium moulé sous pression. La bride de fixation en aluminium (fournie) permet l'orientation du phare sur 180°.

Caractéristiques optiques

6x LED Epistar 3W haute luminosité. Température de couleur 6000K. Faisceau lumineux 25°.

Codici / Codes

LED WORK LAMP 18W 6LED

10/30V DC

44000

LWL 21W 14LED



LWL 21W 14LED

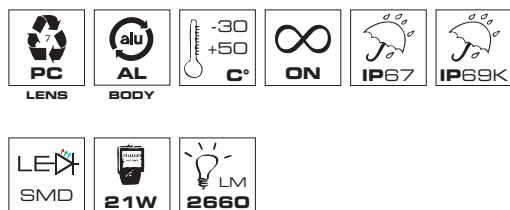

LWL 21W 14LED

V DC	12	24
A	2,15	1,0

In dotazione
Supplied with
Fourni avec

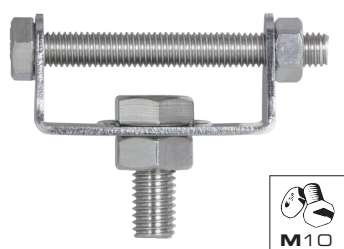

STAFFA DI FISSAGGIO
MOUNTING BRACKET
BRIDE DE FIXATION



Codici / Codes

LED WORK LAMP 21W 14LED

10/30V DC

44006

Faro da lavoro a LED adatto all'utilizzo professionale per illuminazione su veicoli. I LED di tipo Osram consentono l'utilizzo del dispositivo **LWL 21W 14LED** per almeno 30000 ore di lavoro annullando i costi di manutenzione e garantendo un risparmio energetico.

Tensione operativa
10/30V DC +/-10%

Caratteristiche meccaniche
Lente in policarbonato e corpo in alluminio pressofuso.
Staffa di fissaggio in acciaio inossidabile fornita.
Fissaggio tramite vite M10.

Caratteristiche luminose
14x LED Osram ad alta luminosità.
Temperatura di colore 6000K.
Fascio luminoso 60°.

Certificazioni / Certifications



E50 10R-050076

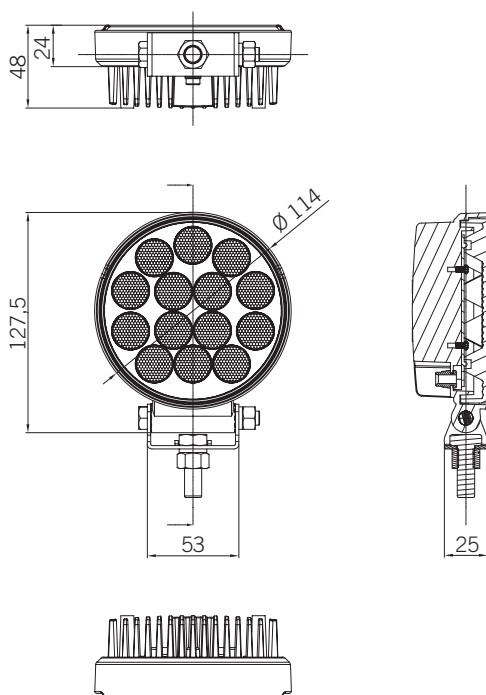

LWL 21W 14LED



LED work lamp ideal for professional vehicle lighting applications. The super bright Osram LEDs allow using the device **LWL 21W 14LED** for over 30000 hours drastically reducing maintenance costs and enhancing energy savings.

Voltage
10/30V DC +/-10%

Mechanical features
Polycarbonate lens with diecast aluminum body. Stainless steel mounting bracket supplied. Fixing through screw M10.

Optical features
14x super bright Osram LEDs.
Color temperature 6000K.
Light beam 60°.



Phare de travail à LED haute puissance adapté à l'éclairage professionnel pour véhicules. Les LED Osram du phare **LWL 21W 14LED** garantissent plus de 30000 heures de fonctionnement, un entretien quasi-nul et elles permettent de moins consommer d'énergie.

Tension d'alimentation
10/30V DC +/-10%

Caractéristiques mécaniques
Optique en polycarbonate et boîtier en aluminium moulé sous pression. Bride de fixation en acier inoxydable fournie avec le produit. Fixation par vis M10.

Caractéristiques optiques
14x LED Osram haute luminosité. Température de couleur 6000K. Faisceau lumineux 60°.

T PLUS



T PLUS

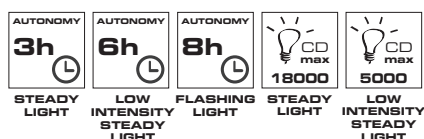
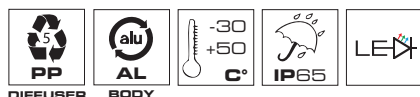

T PLUS

V DC	12	24
A	0,6	0,30

In dotazione Supplied with Fourni avec



CARICA BATTERIE 240V
240V BATTERY CHARGER
CHARGEUR DE BATTERIE 240V



CARICA BATTERIE DA AUTO
CAR BATTERY CHARGER
CHARGEUR DE BATTERIE
DEPUIS LE VEHICULE

La mini torcia **T PLUS** offre performance ottiche con un design compatto. Dispone di fascio luminoso a LED regolabile e consente di realizzare tre effetti luminosi: luce fissa, luce fissa bassa intensità e luce lampeggiante. In dotazione cono di segnalazione di colore arancio, batteria ricaricabile e carica batteria (240V e da auto).

Tensione di ricarica

12/24V DC

Batteria 3,7V li-ion 3000/mAh (tempo massima di ricarica 150 min.)

Caratteristiche meccaniche

Corpo in alluminio nero e cono di segnalazione in polipropilene.

Caratteristiche luminose

Gruppo ottico costituito da un LED ad alta luminosità che consente di realizzare tre effetti luminosi: luce fissa, luce fissa bassa intensità e luce lampeggiante.

Certificazioni / Certifications

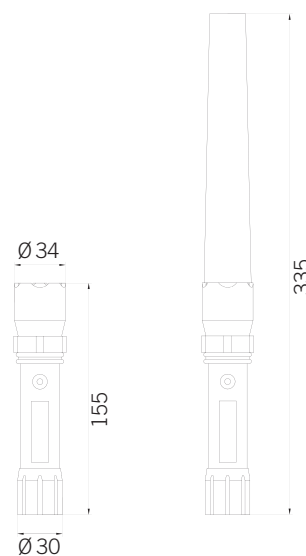

T PLUS



T PLUS mini torch offers excellent optical performance in a compact design. With a powerful projecting adjustable LED span, **T PLUS** allows three luminous effects: steady light, low intensity steady light and flashing effect. Supplied with the product: orange signaling diffuser cone, rechargeable battery and chargers (240V and car charger).

Recharge voltage

12/24V DC

Battery 3,7V li-ion 3000/mAh (max. charge time 150 min.)

Mechanical features

Black aluminum body and polypropylene signaling diffuser cone.

Optical features

Optical group made up of 1 very bright LED allowing a high intensity steady light, low intensity steady light and flashing effect.



La mini torche **T PLUS** offre haute performance optique avec un design compact. Avec un faisceau lumineux à LED réglable, la torche produit trois effets lumineux : lumière fixe, lumière fixe basse intensité et lumière clignotante. Avec le produit sont fournis : le diffuseur de signalisation orange, la batterie rechargeable et les chargeurs (240V et le chargeur depuis le véhicule).

Tension de recharge

12/24V DC

Batterie 3,7V li-ion 3000/mAh (temps max. de recharge 150 min.)

Caractéristiques mécaniques

Corps noir réalisé en aluminium et diffuseur de signalisation en polypropylène.

Caractéristiques optiques

Grouppe optique constitué par une LED très lumineuse produisant trois effets lumineux : lumière fixe, lumière fixe basse intensité et lumière clignotante.

Codici / Codes

T PLUS

74909

FORK PLUS



FORK PLUS

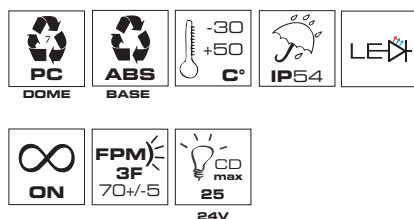

FORK PLUS

V DC	12 ÷ 24 ÷ 48 ÷ 80 ÷ 100
mA	130 140 60 35 30

**Esempio di applicazione / Application example
Exemple d'application**



**Può essere utilizzato con / Can be used with
Peut être utilisé avec**



INDIGO
TRACCIA LUMINOSA 84668 (vedi pag. 200)
OPTICAL DRIVING PATH WARNING DEVICE 84668 (see page 200)
DISPOSITIF D'AVERTISSEMENT OPTIQUE 84668 (voir page 200)



REVERSER
ALLARME BACK-UP 52341 (vedi pag. 202)
BACK-UP ALARM 52341 (see page 202)
ALARME DE RECUL 52341 (voir page 202)

Codici / Codes

FORK PLUS

10/100V DC



84667

Luce a LED multi-tensione sviluppata per incrementare la sicurezza operativa del carrello elevatore. **FORK PLUS** grazie al potente effetto flash è ideale per richiamare l'attenzione di pedoni e di altri veicoli in movimento, particolarmente utile in condizioni dove un rumore di fondo elevato e/o spazi di manovra ridotti e nascosti possono dimostrarsi un pericolo.

Tensione operativa
10/100V DC

Caratteristiche meccaniche
Cupola in policarbonato ad alta resistenza agli impatti.
Base in ABS secondo norma ISO 4148, tipo B1.

Caratteristiche luminose
4 LED ad alta luminosità. La cupola a lente di Fresnel consente di magnificare il fascio luminoso creando un effetto stroboscopico unico (triplo-flash 3F)

Certificazioni / Certifications

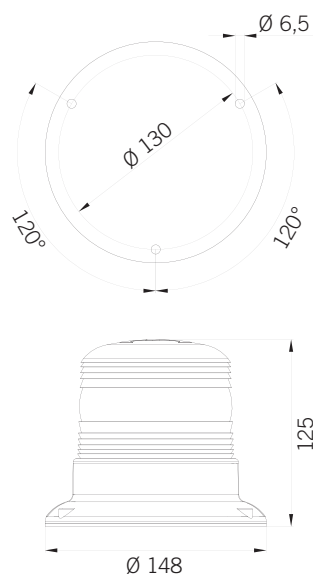

FORK PLUS



Multi-voltage LED beacon engineered to deliver greater safety in forklift operations. **FORK PLUS**, thanks to its powerful strobe effect, is ideal to grab pedestrians' or other vehicles' attention and to increase level of alert in facilities with excessive noise or in aisles and in confusing crossing areas.

Voltages
10/100V DC

Mechanical features
Unbreakable polycarbonate dome allowing high impact resistance. ABS base according to ISO 4148, standard form B1.

Optical features
4 powerful LEDs. The dome (Fresnel lens) intensifies the triple-flash strobe effect (3F).



Feu LED multi-tension conçu pour améliorer la sécurité d'utilisation des chariots élévateurs. **FORK PLUS** grâce à son puissant effet flash est idéal pour attirer l'attention des piétons ou d'autres véhicules et particulièrement utile dans des conditions où le bruit de fond est élevé et/ou des espaces de travail réduits et cachés peuvent s'avérer un danger.

Tension d'alimentation
10/100V DC

Caractéristiques mécaniques
Dôme en polycarbonate résistant aux chocs. Base en ABS selon la norme ISO 4148, forme B1.

Caractéristiques optiques
La technologie 4 LED et la lentille de Fresnel du dôme permettent d'augmenter la puissance du faisceau lumineux, créant un incomparable effet stroboscopique (triple éclats 3F).

INDIGO



INDIGO



INDIGO

V DC	12 ÷ 24 ÷ 48 ÷ 60 ÷ 90 ÷ 100
mA	220 100 60 50 40 35

Esempio di applicazione / Application example
Exemple d'applicationPuò essere utilizzato con / Can be used with
Peut être utilisé avec

FORK PLUS
LAMPEGGIANTE LED 84667 (vedi pag. 199)
LED BEACON 84667 (see page 199)
FEU LED 84667 (voir page 199)



REVERSER
ALLARME BACK-UP 52341 (vedi pag. 202)
BACK-UP ALARM 52341 (see page 202)
ALARME DE RECUL 52341 (voir page 202)

Codici / Codes

INDIGO

10/100V DC

84668

Dispositivo luminoso sviluppato per incrementare la sicurezza operativa del carrello elevatore, tramite proiezione a terra di un intenso fascio luminoso di colore blu, qualche metro più avanti rispetto alla direzione di marcia. **INDIGO** segnala la presenza del carrello elevatore al personale e ai mezzi che transitano in prossimità della potenziale zona di collisione.

Tensione operativa

10/100V DC

Caratteristiche meccaniche

Corpo e cupola in policarbonato ad alta resistenza alle vibrazioni e agli impatti.

Caratteristiche luminose

La luce a LED blu, proiettata sulla parabola, produce un intenso fascio luminoso.

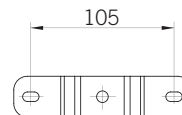
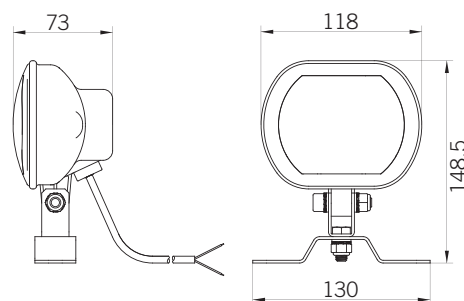
Certificazioni / Certifications

INDIGO



Visual driving path warning aid engineered to deliver extra safety in forklift operations by projecting a powerful blue beam over the floor, few meters ahead of forklift in direction of travel. **INDIGO** warns pedestrians and other vehicles of forklift approach, preventing accidents.

Voltages

10/100V DC

Mechanical features

Unbreakable polycarbonate dome and base allowing high impact resistance.

Optical features

Very bright blue LED light projected on the reflector, producing a rich intense beam.



INDIGO est un produit lumineux spécialement conçu pour améliorer la sécurité de l'environnement des chariots élévateurs, par la projection d'un faisceau lumineux bleu intense sur le sol, à quelque mètre du chariot, dans la direction de marche.

Le dispositif permet d'avertir le personnel et les autres véhicules présents à proximité de la zone à risque de collision de l'approche du chariot élévateur.

Tension d'alimentation

10/100V DC

Caractéristiques mécaniques

Corps et dôme en polycarbonate incassable, dont la résistance est élevée aux vibrations et aux chocs.

Caractéristiques optiques

La lumière LED bleue est très lumineuse, projetée sur le réflecteur, celui-ci produit un intense faisceau lumineux.

LWL REV 18W 6LED



LWL REV 18W 6LED

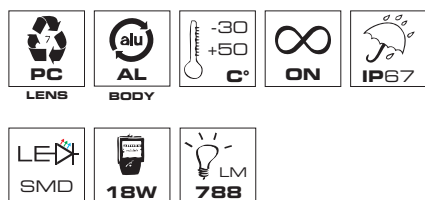

LWL REV 18W 6LED

V DC	12	24
A	1,46	0,7

**In dotazione
Supplied with
Fourni avec**

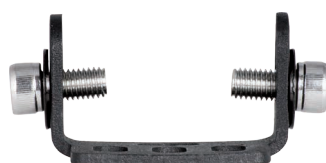

**STAFFA DI FISSAGGIO
MOUNTING BRACKET
BRIDE DE FIXATION**

Codici / Codes

LWL REV 18W 6LED

10/30V DC

44004

Luce di retromarcia a LED adatta all'utilizzo professionale per illuminazione su veicoli. I LED di tipo Epistar consentono l'utilizzo del dispositivo **LWL REV 18W 6LED** per almeno 30000 ore di lavoro, annullando i costi di manutenzione e garantendo un risparmio energetico.

Tensione operativa

10/30V DC +/-10%

Caratteristiche meccaniche

Lente in policarbonato e corpo in alluminio pressofuso.
Staffa di fissaggio in acciaio inossidabile fornita.

Caratteristiche luminose

6x LED Epistar 3W ad alta luminosità.
Temperatura di colore 6000K.

Certificazioni / Certifications

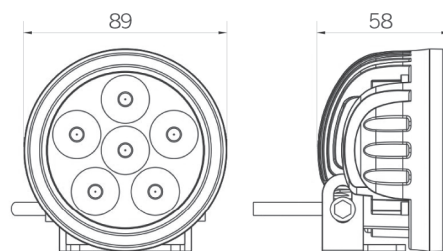

LWL REV 18W 6LED



LED reversing lamp ideal for vehicle-reversing lighting applications.
The super bright Epistar LEDs allow using the device **LWL REV 18W 6LED** for over 30000 hours drastically reducing maintenance costs and enhancing energy savings.

Voltages

10/30V DC +/-10%

Mechanical features

Polycarbonate lens with diecast aluminum body.
Stainless steel mounting bracket supplied.

Optical features

6x 3W super bright Epistar LEDs. Color temperature 6000K.



Phare de recul à LED adapté à l'éclairage de recul professionnel pour véhicules. Les LED Epistar garantissent plus de 30000 heures de fonctionnement du dispositif **LWL REV 18W 6LED**, un entretien quasi-nul et elles permettent de moins consommer d'énergie.

Tension d'alimentation

10/30V DC +/-10%

Caractéristiques mécaniques

Optique en polycarbonate et boîtier en aluminium moulé sous pression. Bride de fixation en acier inox fournie avec le produit.

Caractéristiques optiques

6x LED Epistar 3W haute luminosité. Température de couleur 6000K.

REVERSER



REVERSER



REVERSER

V DC	12 ÷ 24 ÷ 48 ÷ 80 ÷ 100
mA	10 30 30 30 30
dB(A)1m	85 ÷ 95

Esempio di applicazione / Application example Exemple d'application



Può essere utilizzato con / Can be used with Peut être utilisé avec



INDIGO

TRACCIA LUMINOSA 84668 (vedi pag. 200)
OPTICAL DRIVING PATH WARNING DEVICE 84668 (see page 200)
DISPOSITIF D'AVERTISSEMENT OPTIQUE 84668 (voir page 200)



FORK PLUS

LAMPEGGIANTE LED 84667 (vedi pag. 199)
LED BEACON 84667 (see page 199)
FEU LED 84667 (voir page 199)

Codici / Codes

REVERSER

10/100V DC

52341

Dispositivo di segnalazione acustica sviluppato per aumentare la sicurezza durante le operazioni di retromarcia dei carrelli elevatori. Dotato di suono intermittente, **REVERSER** consente di selezionare due livelli di potenza sonora (standard e ridotta). La modalità ridotta permette la segnalazione acustica, senza disturbare gli operatori, in ambienti dove il rumore di fondo è particolarmente basso.

Tensione operativa

10/100V DC

Caratteristiche meccaniche

Corpo in nylon rinforzato fibra di vetro, rivestito in materiale termoplastico per garantire un elevato indice di protezione (IP65). Installazione tramite 4 viti M4 o tramite ghiera di fissaggio disposta nella parte frontale.

Caratteristiche acustiche

Unità piezoelettrica con frequenza pari a 2400Hz +/-100
Potenza sonora in modalità standard: 95 dB(A)1m
Potenza sonora in modalità ridotta: 85 dB(A)1m

Certificazioni / Certifications

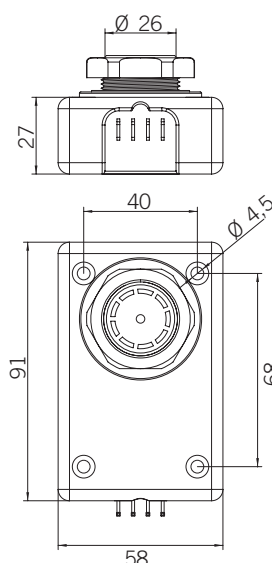

REVERSER



Multi-voltage back-up alarm engineered to deliver safety in forklift operations. With intermittent sound, **REVERSER** allows to select two levels of sound output (Low and High). Low output allows an optimal acoustic signaling function yet without disturbing the operator in environments with very low background noise.

Voltages

10/100V DC

Mechanical features

Fibreglass reinforced nylon body with thermoplastic coating, allows high IP rating (IP 65).
Screw mount (M4) or by means of the front lock ring.

Acoustic features

Piezoelectric unit, frequency 2400 Hz +/-100
Acoustic output: 95 dB(A)1m
Reduced acoustic output: 85 dB(A)1m



L'alarme de recul multitenion **REVERSER** est proposée pour accroître la sécurité de mouvement de recul des chariots élévateurs. Avec le son intermittent, en fonction des connexions électriques, il est possible de sélectionner 2 niveaux de puissance acoustique (standard ou réduite). La puissance acoustique réduite permet la signalisation acoustique sans perturber les opérateurs dans des environnements où le bruit de fond est particulièrement faible.

Tension d'alimentation

10/100V DC

Caractéristiques mécaniques

Corps en nylon renforcé fibre de verre avec revêtement en matériel thermoplastique qui garantit un degré de protection très élevé (IP65). Fixation par vis (M4) ou par collier frontal.

Caractéristiques acoustiques

Unité piézoélectrique avec fréquence de 2400Hz +/-100
Puissance sonore 95 dB(A)1m au niveau standard
Puissance sonore 85 dB(A)1m en puissance réduite



ACCESSORI PER DISPOSITIVI LUMINOSI ACCESSORIES FOR LUMINOUS DEVICES ACCESSOIRES POUR DISPOSITIFS LUMINEUX

SPINOTTI / ADAPTER SOCKETS / PRISES DE CONNEXION

S Spinotto da saldare
Adapter socket to be welded
Prise de connexion à souder



83001

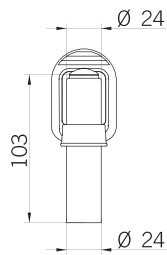

FZ Spinotto filettato, dado in zama
Threaded adapter socket, zamak nut
Prise de connexion filetée, écrou en zamak



83508

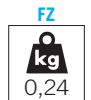
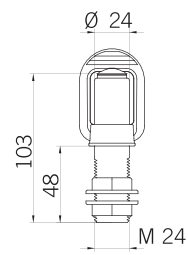

B Spinotto con base
Adapter socket with base
Prise de connexion avec embase



83002

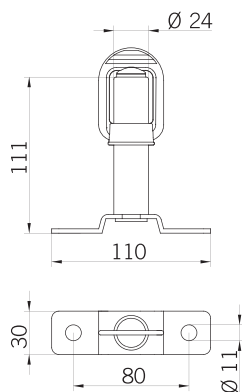

SP Spinotto con attacco a parete
Wall mount adapter socket
Prise de connexion pour fixation en applique



83036

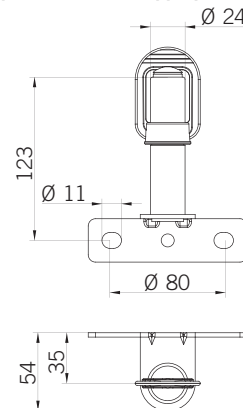

FZP Spinotto filettato con attacco a parete, dado in zama
Wall mount threaded adapter socket, zamak nut
Prise de connexion filetée pour fixation en applique, écrou en zamak



83509

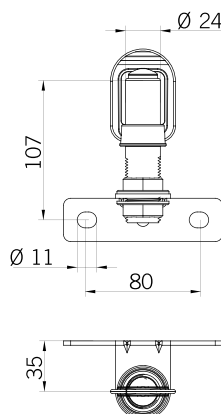

SL Spinotto con staffa per attacco a parete
Adapter socket with bracket for wall mount
Prise de connexion avec potence pour fixation en applique



83498

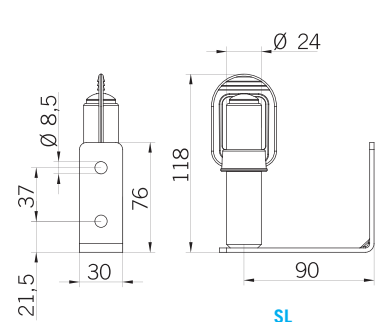

SPL/D Spinotto orientabile dritto
Upright directional support
Support pivotant droit

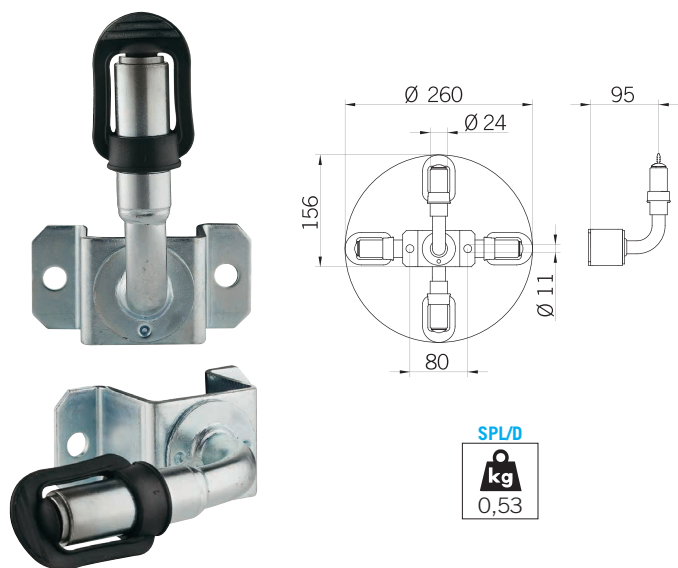

83511

SPL/I Spinotto orientabile inclinato
Tilted directional support
Support pivotant en biseau

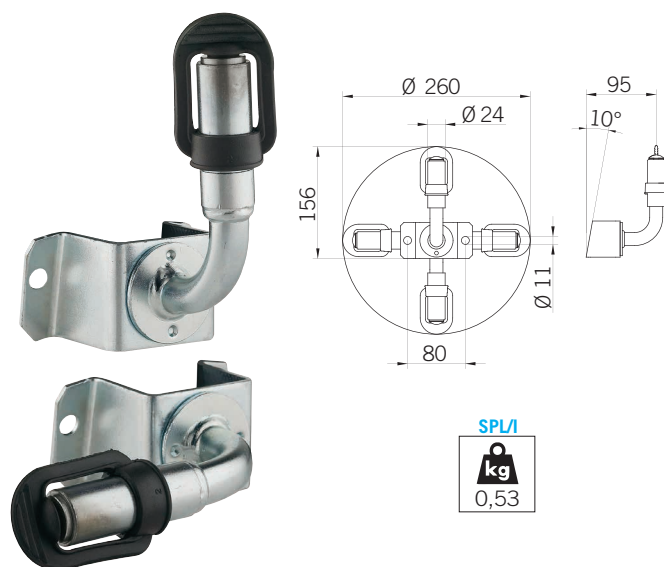

83510

PROLUNGHE / EXTENSION POLES / RALLONGES

SPRT Prolunga telescopica in alluminio
Aluminum telescopic extension pole
Rallonge télescopique rigide en aluminium

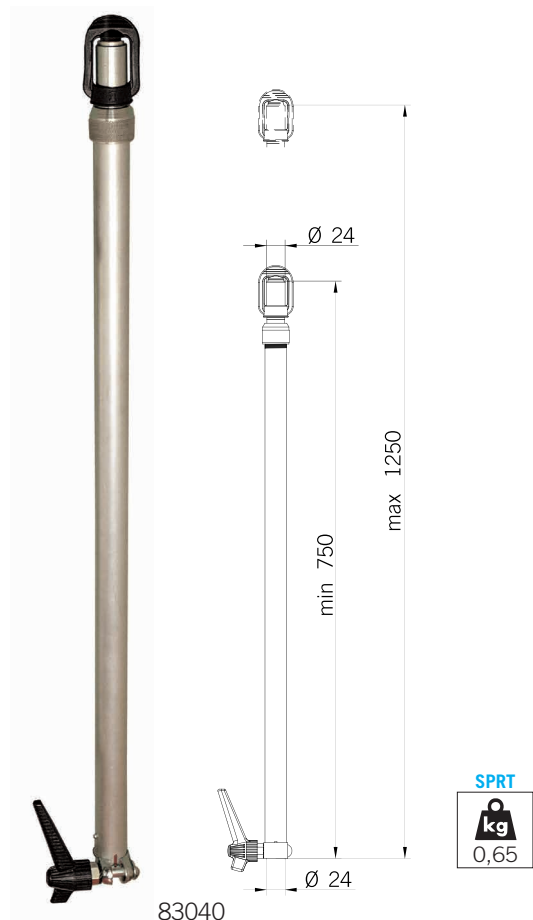

83040

SPR Prolunga in alluminio
Aluminum extension pole
Rallonge rigide en aluminium



83039

Tutti gli spinotti sono dotati di frutto interno in alluminio. Altri accessori disponibili a richiesta.
All adapters have an internal aluminum socket. Other accessories available on request.
Toutes les connexions sont équipées de prise interne en aluminium. Autres accessoires sont disponibles sur demande.

CERTIFICAZIONI E NORMATIVE

RIFERIMENTI NORMATIVI PER L'OMOLOGAZIONE DEI DISPOSITIVI LUMINOSI PER UTILIZZO SU VEICOLI

La **Direttiva Europea 2006/28/CE (e succ. mod.)** e/o il **Regolamento UNECE n. 10** stabiliscono i requisiti cui devono rispondere i veicoli e le unità elettriche/elettroniche a bordo veicolo per quanto riguarda la **compatibilità elettromagnetica**.

La **Direttiva Europea 2006/28/CE** modifica, per adeguamento al progresso tecnico, la direttiva 72/245/CEE, **relativa alla soppressione delle perturbazioni radioelettriche (compatibilità elettromagnetica)** dei veicoli a motore (**omologazione e..**).

Il **Regolamento UNECE n. 10** si applica a tutti i veicoli, relativi componenti e unità elettriche/elettroniche installate a bordo veicolo (fissate meccanicamente allo stesso, in modo tale da non poter essere rimosse senza utensili, oppure connesse in modo permanente/temporaneo al cablaggio del veicolo) per quanto riguarda la compatibilità elettromagnetica (**omologazione E..**).

Per **compatibilità elettromagnetica** s'intende la capacità di veicoli, componenti o singole unità elettriche/elettroniche di funzionare nel proprio ambiente elettromagnetico in modo soddisfacente (immunità), senza introdurre perturbazioni elettromagnetiche inaccettabili per quanto si trova in tale ambiente (emissione).

I dispositivi luminosi prodotti da Sirena S.p.A., per utilizzo su veicoli autorizzati, sono conformi ai requisiti previsti dalla Direttiva 2006/28/CE (e succ. mod.) o dal Regolamento UNECE n. 10 e quindi dispongono del previsto numero di omologazione.

Regolamento UNECE n. 65 - Prescrizioni uniformi relative all'omologazione di dispositivi speciali di segnalazione luminosa per veicoli a motore e loro rimorchi.

Il **Regolamento UNECE n. 65** si applica ai dispositivi speciali di segnalazione luminosa destinati ai veicoli a motore e loro rimorchi.

Per **"dispositivo speciale di segnalazione"** s'intende un dispositivo che emette luce intermittente di colore blu, ambra o rosso, utilizzato su veicoli.

I dispositivi si distinguono in:

"Luci rotanti o lampeggianti": dispositivi che emettono luce intermittente tutto intorno al proprio asse verticale (categoria T);

"Luci lampeggianti direzionali": dispositivi che emettono luce intermittente in un settore angolare limitato (categoria X);

"Barre complete": dispositivi che comportano due o più sistemi ottici che emettono luce intermittente tutto intorno al proprio asse verticale.

I dispositivi luminosi possono avere uno (Classe 1) o due livelli (Classe 2) d'intensità luminosa.

Il **Regolamento UNECE n. 65** stabilisce tra l'altro alcune specifiche che i dispositivi speciali di segnalazione devono avere per poter essere omologati:

- **specifiche di ordine generale** (resistenza alle vibrazioni e all'acqua, frequenza di accensione e spegnimento, range di temperatura di funzionamento, protezione contro manipolazione impropria...)

- **specifiche fotometriche** (valori minimi e massimi dell'intensità luminosa effettiva)

- **caratteristiche colorimetriche** della luce emessa attraverso il filtro (blu/ambra/rosso) espressa in coordinate cromatiche.

I dispositivi luminosi prodotti da Sirena S.p.A. sono conformi ai requisiti previsti dal Regolamento UNECE n. 65.



CERTIFICATIONS AND NORMATIVES

NORMATIVE REFERENCES FOR APPROVAL OF LUMINOUS DEVICES FOR AUTHORIZED VEHICLES

European Directive 2006/28/EC (and subsequent amendments) and/or Regulation UNECE No. 10 determine the requirements that vehicles and electrical and/or electronic devices (intended to be fitted in these vehicles) should fulfill with regard to electromagnetic compatibility.

European Directive 2006/28/EC amends, for the purposes of their adaptation to technical progress, Council Directive 72/245/EEC, relating to the radio interference (electromagnetic compatibility) of motor vehicles (approval [e..]).

Regulation UNECE No. 10 applies to vehicles, components or electrical/electronic units (mechanically fastened to the vehicle so that they cannot be removed without use of tools or connected permanently or temporarily to the vehicle wiring harness) with regard to electromagnetic compatibility (approval [E..]).

Electromagnetic compatibility means the ability of a vehicle or components or separate technical units to function satisfactorily (immunity) in its electromagnetic environment without introducing intolerable electromagnetic disturbances to anything in that environment (emission).

Luminous warning devices manufactured by Sirena, intended to be used on authorized vehicles, fulfil the requirements of the European Directive 2006/28/EC (and subsequent amendments) or of the Regulation UNECE No. 10 and have therefore be assigned an approval number.

Regulation No. 65 - Uniform provisions concerning the approval of special warning lamps for power-driven vehicles and their trailers.

Regulation UNECE No. 65 applies to special warning lamps for power-driven vehicles and their trailers.

“Special warning lamp” means a lamp emitting blue, amber or red light intermittently for use on vehicles.

It is possible to distinguish devices among:

“Rotating or stationary flashing lamp” means a special warning lamp emitting light intermittently all around its vertical axis (Category T).

“Directional flashing lamp” means a special warning lamp emitting light intermittently in a limited angular area (Category X).

“Complete bar” means a special warning lamp with two or more optical systems emitting light intermittently all around its vertical axis.

Special warning lamp could have one level of intensity (class 1), or two levels of intensity (class 2).

Regulation UNECE No. 65 outlines i.a. specifications that special warning lamps should comply with in order to obtain the approval:

- general specifications (vibration and water resistance, frequency, the “ON” and the “OFF” time, operating temperature range, tamperproof...)
- photometric specifications (minimum and maximum values of the effective luminous intensity)
- colorimetric characteristics of the light emitted through the filter/covers (blue/amber/red) expressed in chromaticity coordinates.

Luminous warning devices manufactured by Sirena fulfill the requirements of Regulation UNECE No. 65.



CERTIFICATIONS ET NORMES

NORMES DE REFERENCE POUR L'HOMOLOGATION DES DISPOSITIFS DE SIGNALISATION LUMINEUSE POUR VEHICULES PRIORITAIRES

La Directive Européenne 2006/28/CE (et modifications successives) et/ou le Règlement UNECE N° 10 établissent les prescriptions auxquelles les véhicules et les composants, les systèmes électriques et électroniques à bord des véhicules, doivent répondre par rapport à la compatibilité électromagnétique.

La Directive Européenne 2006/28/CE modifie, aux fins de son adaptation au progrès technique, la Directive 72/245/CEE relative à la suppression des parasites radioélectriques (compatibilité électromagnétique) des véhicules (homologation [e..]).

En ce qui concerne la compatibilité électromagnétique (homologation [E..]) le Règlement UNECE N° 10 s'applique aux véhicules, aux composants et unités électroniques/électriques destinés à être montés sur ces véhicules (fixés mécaniquement au véhicule et impossible à démonter ou à enlever sans outils, ou connectés de manière permanente ou temporaire au faisceau de câblage du véhicule).

La compatibilité électromagnétique est l'aptitude des véhicules, ou d'un composant ou des unités électroniques/électrique séparées, à fonctionner dans son environnement électromagnétique de manière satisfaisante (immunité), sans produire des perturbations électromagnétiques pour tout objet se trouvant dans cet environnement (émission).

Les dispositifs lumineux produits par Sirena, pour utilisation sur véhicules autorisés, sont conformes aux prescriptions de la Directive Européenne 2006/28/CE (et modifications successives) ou du Règlement UNECE N° 10, ils ont donc le numéro d'homologation réglementaire.

Règlement UNECE N° 65 - Prescriptions uniformes relatives à l'homologation des feux spéciaux d'avertissement pour véhicules à moteur et leurs remorques.

Le Règlement UNECE N° 65 s'applique aux feux spéciaux d'avertissement pour véhicules à moteur et leurs remorques.

Par “Feu spécial d'avertissement”, on entend un feu émettant une lumière intermittente bleue, jaune-rouge ou rouge, utilisé sur les véhicules et sur leurs remorques.

Par “Feu tournant ou à éclats stationnaire” on entend un feu spécial d'avertissement émettant une lumière intermittente tout autour de son axe vertical (Catégorie T).

Par “Feu à éclat directionnel” on entend un feu spécial d'avertissement émettant une lumière intermittente dans un secteur angulaire limité (Catégorie X).

Par “Rampes lumineuse complète” on entend un feu spécial d'avertissement comportant deux ou plus de deux systèmes optiques, émettant une lumière intermittente tout autour de son axe vertical.

Les feux spéciaux peuvent avoir un niveau d'intensité lumineuse (classe 1) ou deux niveaux d'intensité lumineuse (classe 2).

Le Règlement UNECE N° 65 établit encore :

- des spécifications d'ordre générales (résistance aux vibrations et aux corps liquides, le temps d'allumage et d'extinction, la plage de température de fonctionnement, la protection contre toute manipulation inadaptée...)
- des spécifications photométriques (les intensités lumineuses effectives)
- des caractéristiques colorimétriques de la lumière émise à travers les filtres/dômes utilisés (bleu/jaune-rouge) indiquée en coordonnées trichromatiques.

Les dispositifs lumineux produits par Sirena sont conformes aux prescriptions prévues par le Règlement UNECE N° 65.



EXPRO

Dispositivi antideflagranti ATEX
Explosion-proof ATEX devices
Dispositifs antidéflagrants ATEX



SIRENA



212 A prova di esplosione Explosion-proof range Protection antidéflagrante

214 Suonerie e Sirene Bells and Sirens Sonneries et Sirènes

- 216 EX SIAD - SIADEL
- 217 EX 055 MCL - MCT
- 218 EX 065 SCL - SCT
- 219 ETH 12 - 20 MD



220 Luci Beacons Feux

- 222 EX 050 OVO M SMD
- 223 EX 070 FLR S
- 224 EX 070 SLR S
- 225 EX 0100 STF 15J
- 226 EX 080 RA - RA H
- 227 EX 080 LA - LA H



228 Interruttori e Spie Switches and Pilot Lights Boutons Poussoirs et Voyants

- 228 EX 025 PAG
- 228 EX 045 LD PAG SP



229 Lampade ricambio Spare bulbs Ampoules de rechange

230 Normative e specifiche tecniche Normatives and Technical Specifications Normes et Spécifications Techniques

A PROVA DI ESPLOSIONE

Da oltre 40 anni Sirena progetta, sviluppa e produce i migliori dispositivi per la segnalazione acustica e luminosa.

L'esperienza maturata, la costante innovazione tecnologica e il continuo adeguamento alle normative internazionali sono i principi fondamentali trasferiti al settore delle apparecchiature di segnalazione antideflagranti.

Sin dai primi anni ottanta, Sirena è presente nel settore antideflagrante proponendo una grande versatilità di gamma ed elevati standard qualitativi e di sicurezza.

Questa sezione, dedicata alla segnalazione acustica e luminosa in esecuzione antideflagrante (Ex-d e Ex-de), è rivolta principalmente a quei settori in cui si possono formare atmosfere esplosive per la presenza di gas e/o polveri combustibili, quali ad esempio raffinerie, industrie chimiche, industrie farmaceutiche e alimentari. Tali apparecchiature devono garantire la sicurezza delle persone che operano in tali luoghi.

La linea acustica include suonerie (EX SIAD, SIADDEL), sirene elettromeccaniche (EX MCL, MCT, SCL, SCT) e sirene elettroniche (ETH 12 e 20 MD). La linea luminosa propone luci a LED SMD multifunzione (EX OVO M SMD, EX FLR S, EX SLR S), tecnologia volta ad incrementare le performance ottiche e la durabilità del prodotto, eliminando virtualmente i costi di gestione legati alla manutenzione di questi dispositivi. Si affiancano a essi i prodotti più tradizionali come la luce allo Xenon da 15J (EX STF) e le luci rotanti, fisse e lampeggianti in versione con lampada a filamento o alogena (EX RA, EX LA).

Completano la gamma l'interruttore EX PAG per l'attivazione di sistemi di allarme o allertamento e la spia luminosa EX LD PAG SP per la segnalazione del corretto funzionamento di tali sistemi installati in ambienti con atmosfera esplosiva.

La gamma antideflagrante Sirena è stata certificata dal CESI, Organismo Notificato dal Governo Italiano ai sensi della Direttiva ATEX 2014/34/UE per la certificazione di apparecchiature elettriche destinate a zone a rischio di esplosione.

Tutta la gamma **EXPRO** Sirena è stata certificata nel Gruppo II, ossia in tutte quelle situazioni che prevedono installazioni in zone ad alto rischio, miniere escluse.

La Categoria assegnata è la 2, il che consente di utilizzare la gamma ATEX Sirena nelle Zone 1, 2, 21 e 22 quindi sia in presenza di gas (G: gas) che in presenza di polveri (D: dust).

La certificazione è conforme alla norma EN/IEC 60079 che abilita all'utilizzo del marchio Ex.

Il Modo di protezione dei dispositivi è costituito da una custodia a prova di esplosione e a sicurezza aumentata che garantisce lo status "de" (in presenza di atmosfera potenzialmente esplosiva con GAS) e "tb" (in presenza di atmosfera potenzialmente esplosiva con polveri).

Il Gruppo di esplosione approvato per la gamma Sirena, particolarmente importante per l'utilizzo in atmosfera esplosiva dovuta a gas, è il IIC, il più pericoloso che include anche Idrogeno e Acetilene. Per quanto riguarda il gruppo di esplosione, relativo ad atmosfera esplosiva per la presenza di polveri, i dispositivi Sirena sono certificati per il IIIC, ossia sono idonei ad essere installati in presenza di qualsiasi polvere (anche polveri conduttive).

Alla gamma ATEX è stata assegnata la Classe di Temperatura T6, la più difficile da ottenere, poiché garantisce una temperatura massima sulla superficie della custodia di soli 85°C.

La gamma **EXPRO** offre inoltre il Livello di Protezione IP66. Questo codice definisce che le apparecchiature antideflagranti Sirena sono totalmente protette contro la polvere (prima cifra) e i getti d'acqua potenti (seconda cifra).



EXPLOSION-PROOF RANGE

Sirena has been designing, developing and producing top quality audible and visual signaling devices for the past 40 years.

The experience gained, the constant technological innovation and the continuous updating to international standards are fundamental principles conveyed to explosion-proof signaling devices.

Since the 1980's, Sirena has been present in the explosion-proof market, offering greater versatility in its range with high quality and safety standards.

This section, dedicated entirely to audible and visual signaling devices in explosion proof execution (Ex-d and Ex-de), is intended primarily for those particular sectors where explosive atmospheres may occur due to the presence of gas and/or combustible dust, such as oil refineries, chemical and pharmaceutical industries, food industries.

The acoustic range includes bells (EX SIAD, SIADEL), electromechanical sirens (EX MCL, MCT, SCL, SCT) and electronic sirens (ETH 12 and 20 MD). The luminous range offers multifunctional SMD LED beacons (EX OVO M SMD, EX FLR S, EX SLR S), a technology that increases both the optical performance and lifetime of the product, as well as virtually eliminating maintenance costs of these devices. In addition remain the more traditional beacons such as 15J Xenon beacon (EX STF), rotating, steady and flashing light beacons with both filament or halogen bulbs (EX RA, EX LA).

EX PAG switch, ideal for activating alarm/warning systems, and pilot light EX LD PAG SP, for signaling the correct functioning of alarm/warning systems in explosive atmospheres, complete the range.

Sirena's explosion proof range of products has been approved by CESI, Notified Body of the Italian Government, according to ATEX Directive 2014/34/UE for the certification of explosion proof devices intended for use in potentially explosive atmospheres.

Sirena's entire **EXPRO** range has been certified in Group II, that foresees installation in all high-risk areas, excluding mines.

EXPRO range of products has been appointed Category 2, that allows use in Zone 1, 2, 21 and 22, in both the presence of gas (G) as well as dust (D).

Certification is according to EN/IEC 60079 directive that allows the use of the Ex identifying mark.

Type of Protection of the devices is provided by an explosion proof housing with increased safety, guaranteeing "de" status (in presence of GAS potentially explosive atmospheres) and "tb" (in presence of DUST potentially explosive atmospheres).

The proven explosion Group, particularly important for use in explosive atmospheres due to gas, is IIC, the most dangerous, that includes Hydrogen and Ethyl Acetate. The proven explosion Group for use in explosive atmospheres due to dust, is IIIC, it means that **EXPRO** products can be used in presence of any dust (also conductive dust).

The whole range is certified for use in class T6 temperature that guarantees a maximum surface temperature of the housing of just 85°C, that is the most difficult to obtain.

The range has also been granted a protection degree of IP66, that means it is totally protected from dust (first digit) and powerful jets of water (second digit).



PROTECTION ANTIDÉFLAGRANTE

Depuis plus de 40 ans, Sirena conçoit, développe et fabrique les meilleurs dispositifs de signalisation acoustiques et lumineux.

L'expérience acquise, l'innovation technologique constante et l'adaptation continue à l'évolution des normes internationales sont les principes fondamentaux à la base de notre gamme de dispositifs de signalisation antidéflagrants.

Depuis le début des années quatre-vingt, Sirena est présente dans le secteur antidéflagrant avec une polyvalence de gamme tout en assurant un standard de qualité et de sécurité extrêmement élevé.

Cette section, dédiée aux dispositifs pour la signalisation acoustique et lumineuse en application antidéflagrante (Ex-d et Ex-de), s'adresse principalement aux secteurs dans lesquels une atmosphère explosive peut se former en raison de la présence de gaz, vapeurs et/ou poussières inflammables, tels que : les raffineries, les industries chimiques, pharmaceutiques et alimentaires. Ces dispositifs doivent garantir la sécurité des personnes opérant dans ces lieux.

La gamme acoustique inclut les sonneries (EX SIAD, SIADEL), les sirènes électromécaniques (EX MCL, MCT, SCL, SCT) et les sirènes électroniques (ETH 12 et 20 MD).

La gamme lumineuse propose des feux à LED SMD multifonctionnels (EX OVO M SMD, EX FLR S, EX SLR S), une technologie visant à améliorer les performances optiques et la durée de vie des produits, et qui permet d'offrir un entretien quasi-nul. A côté de ces dernières technologies, nous proposons les produits traditionnels tels que le feu au Xénon 15J (EX STF), les feux tournants, fixes ou clignotants en version avec ampoule à incandescence ou halogène H1 (EX RA, EX LA).

Le voyant lumineux EX LD PAG SP et le bouton poussoir EX PAG complètent la gamme.

La gamme antidéflagrante **EXPRO** de Sirena a été certifiée par le CESI, l'Organisme Notifié selon la Directive ATEX 2014/34/UE pour la certification des appareils et des systèmes antidéflagrants qui peuvent être employés dans des zones à risque d'explosion.

Toute la gamme **EXPRO** de Sirena a été certifiée pour l'installation dans le Groupe II, c'est-à-dire dans des lieux soumis aux atmosphères explosives autres que les mines grisouteuses.

Elle a été classée dans la catégorie 2 qui permet l'installation de la gamme ATEX dans les Zones 1, 2, 21 et 22 soit en présence de gaz (G : gaz) soit de poussières (D : dust).

La certification est conforme à la norme EN/IEC 60079 qui permet l'utilisation du code Ex.

Le mode de protection des dispositifs est une enveloppe antidéflagrante à sécurité augmentée qui garantit le statut « de » (en présence d'une atmosphère explosive type gaz) et « tb » (en présence d'une atmosphère explosive type poussière).

Le Groupe d'explosion certifié pour toute la gamme Sirena est le IIC (pour atmosphères explosibles type gaz), le plus dangereux, incluant Hydrogène et Acétylène. Pour les atmosphères explosives type poussière, les dispositifs Sirena sont certifiés pour le IIIC, c'est-à-dire qu'ils sont appropriés pour l'installation en présence de tout type de poussières (même poussières conductrices).

A notre gamme ATEX a été attribuée la Classe de Température T6, la plus difficile à obtenir, car elle garantit une température de surface maximale de l'enveloppe de 85°C seulement.

Par ailleurs la gamme **EXPRO** offre un indice d'étanchéité IP66, totalement protégée contre les poussières (premier chiffre) et contre les jets d'eau puissants (deuxième chiffre).





SUONERIE E SIRENE BELLS AND SIRENS SONNERIES ET SIRENES



EX SIAD-SIADEL



EX 165 SIAD
EX 165 SIADEL



EX 215 SIAD
EX 215 SIADEL



EX SIAD 165

V AC	12	24	110	240
mA	860	430	90	50
dB(A)1m	100			

EX SIADEL 165

V DC	12	24	110	240
mA	600	300	60	28
dB(A)1m	98			

EX SIAD 215

V AC	240
mA	50
dB(A)1m	100

EX SIADEL 215

V DC	24
mA	300
dB(A)1m	98

Modo di protezione
Methods of Protection
Mode de protection



II 2G Ex d e IIC T6 Gb

Codici / Codes

EX 165 SIAD - SIADEL

	SIAD (AC)	SIADEL (DC)
12V	62258	62273
24V	62259	62274
110V	62261	62276
240V	62262	62277

EX 215 SIAD - SIADEL

	SIAD (AC)	SIADEL (DC)
24V	-	62279
240V	62267	-

RICAMBI / SPARE PARTS / RECHANGES

GRUPPO BATTENTE / SPARE STRIKER / GROUPE PISTON BATTANT	
165	84080
215	84081

Suonerie antideflagranti disponibili nella versione **EX SIAD 165** (diametro 165 mm) oppure **EX SIAD 215** (diametro 215 mm). Sviluppate con unità elettromagnetica a pistone battente, generano un caratteristico suono continuo. Suonerie antideflagranti del Gruppo II per l'installazione in aree con atmosfera esplosiva zona 1 e 2.

Tensione operativa

EX SIAD 165: 12V AC, 24V AC, 110V AC, 240V AC +/-10%
EX SIADEL 165: 12V DC, 24V DC, 110V DC, 240V DC +/-10%
EX SIAD 215: 240V AC +/-10%
EX SIADEL 215: 24V DC +/-10%

Classe di temperatura

T6

Caratteristiche meccaniche

Corpo in lega di alluminio esente da rame. Dotate di base piana, il fissaggio avviene con viteria standard non fornita. Gruppo battente di ricambio in dotazione.

Caratteristiche acustiche

Unità elettromagnetica a pistone battente. Suono continuo.

Certificazioni / Certifications



0477



CESI 10 ATEX 042 X

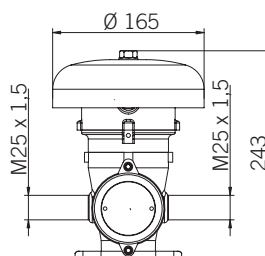
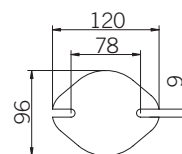
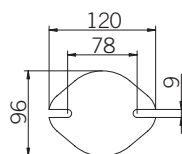

EX 165 SIAD
EX 165 SIADEL



2,32

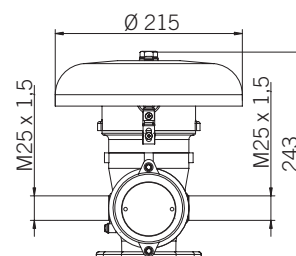

EX 215 SIAD
EX 215 SIADEL



2,95



Explosion-proof bells available with diameter 165 mm **EX SIAD 165** or 215 mm **EX SIAD 215**. Developed with acoustic electromagnetic unit with vibrating piston, the devices generate a characteristic continuous sound. Explosion-proof bells of Group II for use in areas with explosive atmosphere Zones 1 and 2.

Voltages

EX SIAD 165: 12V AC, 24V AC, 110V AC, 240V AC +/-10%
EX SIADEL 165: 12V DC, 24V DC, 110V DC, 240V DC +/-10%
EX SIAD 215: 240V AC +/-10%
EX SIADEL 215: 24V DC +/-10%

Temperature class

T6

Mechanical features

Housing in copper-free aluminum alloy. Provided with flat base. Screw mounting (screws not included). Spare striker supplied with the product.

Acoustic features

Electromagnetic unit with vibrating piston. Continuous Sound.



Sonneries antidéflagrantes disponible en version **EX SIAD 165** (diamètre 165 mm) ou **EX SIAD 215** (diamètre 215 mm). Equipées d'une unité électromagnétique avec piston battant sur la cloche, qui produit un caractéristique son continu. Sonneries antidéflagrantes du Groupe II pour une utilisation en atmosphère explosive, zone 1 et 2.

Tension d'utilisation

EX SIAD 165 : 12V AC, 24V AC, 110V AC, 240V AC +/-10%
EX SIADEL 165 : 12V DC, 24V DC, 110V DC, 240V DC +/-10%
EX SIAD 215 : 240V AC +/-10%
EX SIADEL 215 : 24V DC +/-10%

Classe de température

T6

Caractéristiques mécaniques

Corps en alliage d'aluminium sans cuivre. Equipé avec base plate, fixation par vis standards non fournies. Groupe piston battant de rechange fourni avec le produit.

Caractéristiques acoustiques

Unité électromagnétique avec piston battant. Son continu.

EX 055 MCL-MCT



EX 055 MCL



EX 055 MCT



EX 055 MCL

V ACDC	12	24	48	110	240
A	2,7	1,47	0,85	0,36	0,22
dB(A)1m	97 ±1				

EX 055 MCT

V ACDC	12	24	110	240
A	2,7	1,47	0,36	0,22
dB(A)1m	96 ±1			

Modo di protezione Methods of Protection Mode de protection



II 2GD
Ex d e IIC T6 Gb
Ex tb IIIC T85°C Db

Codici / Codes

EX 055 MCL

12V ACDC	62253
24V ACDC	62254
48V ACDC	62255
110V ACDC	62256
240V ACDC	62257

EX 055 MCT

12V ACDC	62248
24V ACDC	62249
110V ACDC	62251
240V ACDC	62252

Sirene elettromeccaniche antideflagranti, ad alta precisione meccanica, le EX 055 MCL e EX 055 MCT generano un suono lungo e acuto. Sirene elettromeccaniche antideflagranti del Gruppo II per l'installazione in aree con atmosfera esplosiva zona 1, 2, 21 e 22.

Tensione operativa

EX 055 MCL: 12V ACDC, 24V ACDC, 48V ACDC, 110V ACDC, 240V ACDC +/-10%
EX 055 MCT: 12V ACDC, 24V ACDC, 110V ACDC, 240V ACDC +/-10%

Classe di temperatura

T6

Caratteristiche meccaniche

Corpo in lega di alluminio esente da rame. Dotate di base piana, il fissaggio avviene con viteria standard non fornita.

Caratteristiche acustiche

Sirene elettromeccaniche con suono lineare. Frequenze: 1600 ±100Hz.

Certificazioni / Certifications



0477



CESI 10 ATEX 038 X

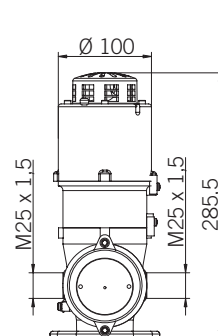
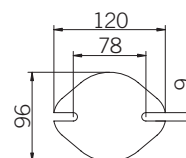
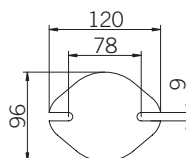

EX 055 MCL

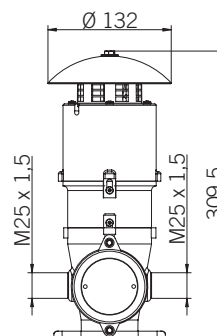

EX 055 MCT



Explosion-proof electro-mechanical sirens, high mechanical precision, EX 055 MCL and EX 055 MCT generate a long high-pitched sound. Explosion-proof electromechanical sirens of Group II for use in areas with explosive atmosphere Zones 1, 2, 21 and 22.

Voltages

EX 055 MCL: 12V ACDC, 24V ACDC, 48V ACDC, 110V ACDC, 240V ACDC +/-10%
EX 055 MCT: 12V ACDC, 24V ACDC, 110V ACDC, 240V ACDC +/-10%

Temperature class

T6

Mechanical features

Housing in copper-free aluminum alloy. Provided with flat base. Screw mounting (screws not included).

Acoustic features

Electro-mechanical sirens with continuous sound. Frequency: 1600 ±100Hz



Sirènes électromécaniques antidéflagrantes, de très haute précision mécanique, les EX 055 MCL et EX 055 MCT génèrent un son long et aigu. Sirènes électromécaniques antidéflagrantes du Groupe II pour une utilisation en atmosphère explosive, zone 1, 2, 21 et 22.

Tension d'utilisation

EX 055 MCL : 12V ACDC, 24V ACDC, 48V ACDC, 110V ACDC, 240V ACDC +/-10%
EX 055 MCT : 12V ACDC, 24V ACDC, 110V ACDC, 240V ACDC +/-10%

Classe de température

T6

Caractéristiques mécaniques

Corps en alliage d'aluminium sans cuivre. Equipé avec base plate, fixation par vis standards non fournies.

Caractéristiques acoustiques

Sirènes électromécaniques avec son linéaire. Fréquence : 1600 ±100Hz

EX 065 SCL-SCT



EX 065 SCL

V ACDC	48	110	240
A	6	1,7	1,2
dB(A)1m	115 ±1		

EX 065 SCT

V ACDC	110	240
A	1,7	1,2
dB(A)1m	112 ±1	

Modo di protezione Methods of Protection Mode de protection



II 2GD
Ex d e IIC T6 Gb
Ex tb IIIC T85°C Db

Codici / Codes

EX 065 SCL

48V ACDC	62245
110V ACDC	62246
240V ACDC	62247

EX 065 SCT

110V ACDC	62242
240V ACDC	62243

Sirene elettromeccaniche antideflagranti, ad alta precisione meccanica, le **EX 065 SCL** e **EX 065 SCT** generano un suono lungo e acuto. Sirene elettromeccaniche antideflagranti del Gruppo II per l'installazione in aree con atmosfera esplosiva zona 1, 2, 21 e 22.

Tensione operativa

EX 065 SCL: 48V ACDC, 110V ACDC, 240V ACDC +/-10%

EX 065 SCT: 110V ACDC, 240V ACDC +/-10%

Classe di temperatura

T6

Caratteristiche meccaniche

Corpo in lega di alluminio esente da rame. Dotate di base piana, il fissaggio avviene con viteria standard non fornita.

Caratteristiche acustiche

Sirene elettromeccaniche con suono lineare. Frequenze: 1000 ±100Hz.

Certificazioni / Certifications



0477



CESI 10 ATEX 038 X

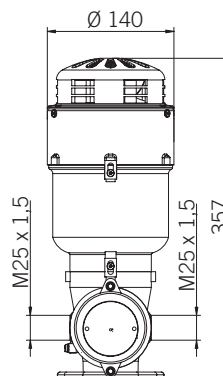
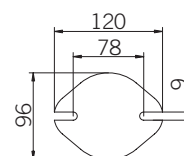
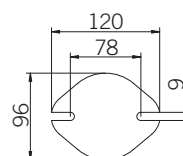

EX 065 SCL

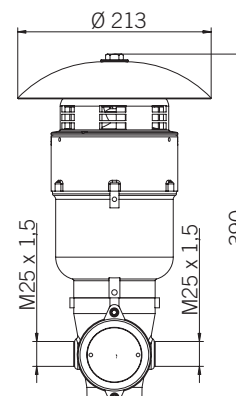

EX 065 SCT



Explosion-proof electro-mechanical sirens, high mechanical precision, **EX 065 SCL** and **EX 065 SCT** generate a long high-pitched sound. Explosion-proof electromechanical sirens of Group II for use in areas with explosive atmosphere Zones 1, 2, 21 and 22.

Voltages

EX 065 SCL: 48V ACDC, 110V ACDC, 240V ACDC +/-10%

EX 065 SCT: 110V ACDC, 240V ACDC +/-10%

Temperature class

T6

Mechanical features

Housing in copper-free aluminum alloy. Provided with flat base. Screw mounting (screws not included).

Acoustic features

Electro-mechanical sirens with continuous sound. Frequency: 1000 ±100Hz



Sirènes électromécaniques antidéflagrantes, de très haute précision mécanique, les **EX 065 SCL** et **EX 065 SCT** génèrent un son long et aigu. Sirènes électromécaniques antidéflagrantes du Groupe II pour une utilisation en atmosphère explosive, zone 1, 2, 21 et 22.

Tension d'utilisation

EX 065 SCL : 48V ACDC, 110V ACDC, 240V ACDC +/-10%

EX 065 SCT : 110V ACDC, 240V ACDC +/-10%

Classe de température

T6

Caractéristiques mécaniques

Corps en alliage d'aluminium sans cuivre. Equipé avec base plate, fixation par vis standards non fournies.

Caractéristiques acoustiques

Sirènes électromécaniques avec son linéaire. Fréquence : 1000 ±100Hz

ETH 12-20 MD



ETH 12 MD

ETH 20 MD

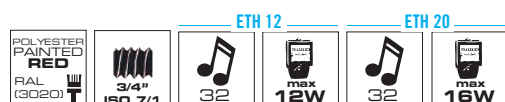

ETH 12 MD			
V ACDC	12 ÷ 24	-	-
V AC	-	110	240
A	0,16	0,07	0,07
dB(A)1m	102	106	106

ETH 20 MD		
V ACDC	12 ÷ 24	-
V AC	-	240
A	0,8	0,15
dB(A)1m	110	110

Modo di protezione Methods of Protection Mode de protection

ETH 12 MD
II 2GD
Ex d IIC T6 Gb
Ex tb IIIC T85°C Db IP65



ETH 20 MD
II 2GD
Ex d IIC T3 Gb
Ex tb IIIC T150°C Db IP6X

Codici / Codes

ETH 12 MD

12/24V ACDC	57994
110V AC	57997
240V AC	57996

ETH 20 MD

12/24V ACDC	57998
240V AC	57995

Sirene elettroniche antideflagranti, le **ETH 12 MD** e **ETH 20 MD** garantiscono un livello acustico di alta gamma con possibilità di scegliere tra 32 tonalità differenti. Sirene elettroniche antideflagranti del Gruppo II per l'installazione in aree con atmosfera esplosiva zona 1, 2, 21 e 22 (**ETH 12 MD**) e in aree con atmosfera esplosiva zona 1 e 2 (**ETH 20 MD**).

Tensione operativa

ETH 12 MD: 12/24V ACDC, 110V AC, 240V AC +/-10%

ETH 20 MD: 12/24V ACDC, 240V AC +/-10%

Classe di temperatura

ETH 12 MD: T6

ETH 20 MD: T3

Caratteristiche meccaniche

Corpo e coperchio in lega di alluminio esente da rame. Dotate di staffa di supporto con fori di fissaggio.

Caratteristiche acustiche

Sirene elettroniche con 32 suoni selezionabili.

ETH 12 MD: Frequenze 340÷2000

ETH 20 MD: Frequenze 440÷2000

Certificazioni / Certifications



0080



INERIS 02 ATEX 0074 X (**ETH 12**)
ISSeP 11 ATEX 040 X (**ETH 20**)

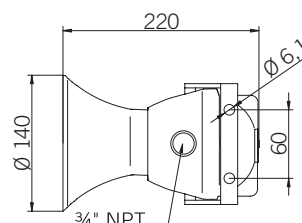

ETH 12 MD

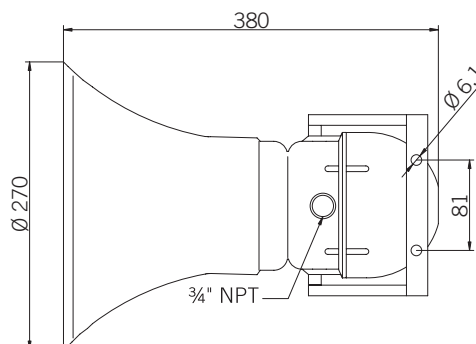

ETH 20 MD



Explosion-proof electronic sirens, **ETH 12 MD** and **ETH 20 MD** guarantee a high range sound level and the possibility to choose from 32 different tones. Explosion-proof electronic sirens of Group II for use in areas with explosive atmosphere Zones 1, 2, 21 and 22 (**ETH 12 MD**) and in areas with explosive atmosphere Zones 1 and 2 (**ETH 20 MD**).

Voltages

ETH 12 MD: 12/24V ACDC, 110V AC, 240V AC +/-10%

ETH 20 MD: 12/24V ACDC, 240V AC +/-10%

Temperature class

ETH 12 MD: T6

ETH 20 MD: T3

Mechanical features

Housing and cover in copper-free aluminum alloy. Provided with bracket with fixing holes.

Acoustic features

Electronic sirens with 32 selectable tones.

ETH 12 MD: Frequencies 340÷2000

ETH 20 MD: Frequencies 440÷2000



Sirènes électroniques antidéflagrantes, les **ETH 12 MD** et **ETH 20 MD** garantissent un niveau acoustique très élevé et la possibilité de sélectionner entre 32 différentes tonalités.

Sirènes électroniques antidéflagrantes du Groupe II pour une utilisation en atmosphère explosive, zone 1, 2, 21 et 22 (**ETH 12 MD**) et zone 1 et 2 (**ETH 20 MD**).

Tension d'utilisation

ETH 12 MD : 12/24V ACDC, 110V AC, 240V AC +/-10%

ETH 20 MD : 12/24V ACDC, 240V AC +/-10%

Classe de température

ETH 12 MD : T6

ETH 20 MD : T3

Caractéristiques mécaniques

Corps et couvercle en alliage d'aluminium sans cuivre. Bride avec trous de fixation.

Caractéristiques acoustiques

Sirènes électroniques avec 32 tonalités sélectionnables.

ETH 12 MD : Fréquences 340÷2000

ETH 20 MD : Fréquences 440÷2000



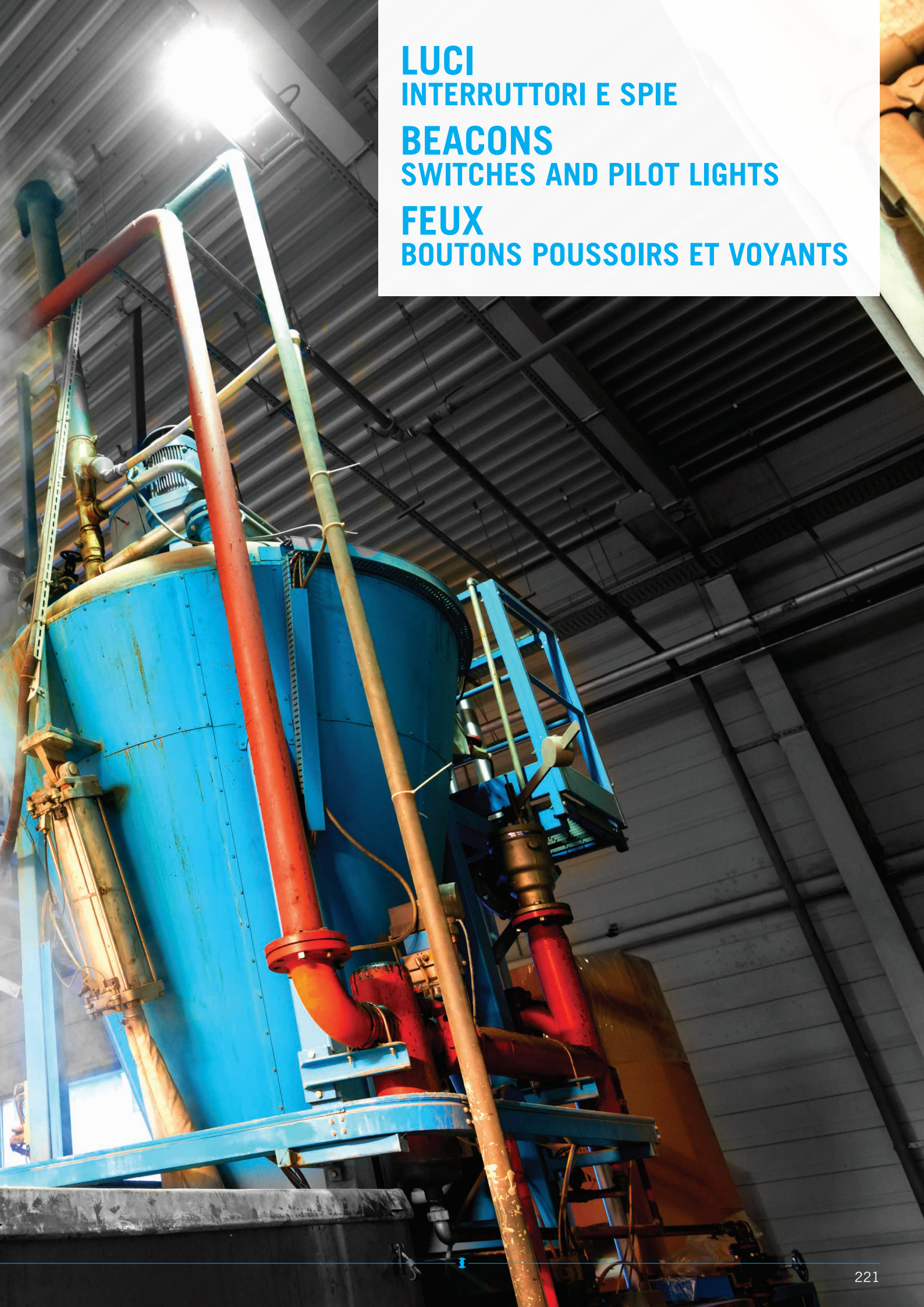

LUCI
INTERRUTTORI E SPIE
BEACONS
SWITCHES AND PILOT LIGHTS
FEUX
BOUTONS POUSSOIRS ET VOYANTS

EX 050 OVO M SMD



EX 050 OVO M SMD

Cupole / Domes / Dômes

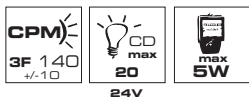
EXTERNAL INTERNAL
DOME DOME

EX 050 OVO M SMD

V ACDC	12÷24	-
V AC	-	90÷240
mA	180	40

Modo di protezione Methods of Protection Mode de protection



II 2G Ex d e IIC T6 Gb
II 2D Ex tb IIIC T85°C Db IP66

Codici / Codes

EX 050 OVO M SMD

12/24V ACDC	97191	97192	97193	97194	97195	97196
90/240V AC	97201	97202	97203	97204	97205	97206

* Specificare la funzione luminosa desiderata al momento dell'ordine.

* Please specify the desired light effect when ordering.

* Spécifier l'effet lumineux souhaité lors de la commande.

Luce a LED integrati antideflagrante di piccole dimensioni, **EX 050 OVO M SMD** è un dispositivo multifunzione che permette 4 tipi di lampeggio* (luce fissa, lampeggio singolo, doppio e triplo) selezionabili tramite dip-switch interno. Questa luce antideflagrante del Gruppo II può essere installata in aree con atmosfera esplosiva zona 1, 2, 21 e 22.

* Specificare la funzione luminosa desiderata al momento dell'ordine.

Tensione operativa

12/24V ACDC, 90/240V AC +/-10%

Classe di temperatura

T6

Caratteristiche meccaniche

Corpo in lega di alluminio esente da rame. Cupola esterna in vetro borosilicato, cupola interna in policarbonato. Dotata di base piana, il fissaggio avviene con viteria standard non fornita.

Caratteristiche luminose

Tecnologia a LED SMD MULTI: 4 diverse funzioni luminose (luce fissa, lampeggio singolo, doppio e triplo) selezionabili tramite dip-switch.

Certificazioni / Certifications



0477



CESI 05 ATEX 043

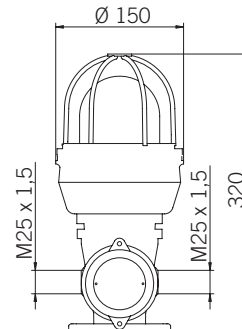
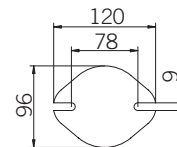

EX 050 OVO M SMD



Small explosion-proof integrated LED beacon, **EX 050 OVO M SMD** is a multifunctional device allowing 4 different light effects* (steady light, single, double or triple flash) selectable via internal dip-switch. This explosion-proof beacon of Group II can be used in areas with explosive atmosphere Zones 1, 2, 21 and 22.

* Please specify the desired light effect when ordering.

Voltages

12/24V ACDC, 90/240V AC +/-10%

Temperature class

T6

Mechanical features

Housing in copper-free aluminum alloy. Borosilicate glass external dome, polycarbonate internal dome. Provided with flat base. Screw mounting (screws not included).

Optical features

LED SMD MULTI technology: 4 different light options (steady light, single, double or triple flash) selectable via internal dip-switch.



Feu LED antidéflagrant de petites dimensions, **EX 050 OVO M SMD** est un dispositif multifonctionnel qui permet 4 effets lumineux* (lumière fixe, simple, double ou triple éclat), sélectionnables par commutateur DIP intérieur. Ce feu antidéflagrant du Groupe II peut être utilisé en atmosphère explosive, zone 1, 2, 21 et 22.

* Spécifier l'effet lumineux souhaité lors de la commande.

Tension d'utilisation

12/24V ACDC, 90/240V AC +/-10%

Classe de température

T6

Caractéristiques mécaniques

Corps en alliage d'aluminium sans cuivre. Dôme externe en verre borosilicate, dôme interne en polycarbonate. Equipé avec base plate, fixation par vis standards non fournies.

Caractéristiques optiques

Technologie LED SMD MULTI : 4 effets lumineux (lumière fixe, simple, double ou triple éclat), sélectionnables par commutateur DIP intérieur.

EX 070 FLR S



EX 070 FLR S

Cupole / Domes / Dômes

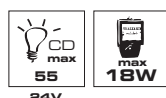

EX 070 FLR S

V ACDC	12 ÷ 24	40 ÷ 80	-
V AC	-	-	120 ÷ 240
mA	510 360	300 110	100 70

Modo di protezione
Methods of Protection
Mode de protection



II 2G Ex d e IIC T6 Gb
II 2D Ex tb IIIC T85°C Db IP66

Codici / Codes

EX 070 FLR S

12/24V ACDC	97211	97212	97213	97214	97216
40/80V ACDC	97241	97242	97243	97244	97246
120/240V AC	97221	97222	97223	97224	97226
12/24V ACDC allCLEAR	-	-	97230	-	-

* Specificare la funzione luminosa desiderata al momento dell'ordine.

* Please specify the desired light effect when ordering.

* Spécifier l'effet lumineux souhaité lors de la commande.

Luce a LED integrati antideflagrante di medie dimensioni, EX 070 FLR S è un dispositivo multifunzione che permette 3 funzioni luminose* (luce fissa, lampeggiante, rotante). Questa luce antideflagrante del Gruppo II può essere installata in aree con atmosfera esplosiva zona 1, 2, 21 e 22.

* Specificare la funzione luminosa desiderata al momento dell'ordine.

Tensione operativa

12/24V ACDC, 40/80V ACDC, 120/240V AC +/-10%

Classe di temperatura

T6

Caratteristiche meccaniche

Corpo in lega di alluminio esente da rame. Cupola esterna in vetro borosilicato, cupola interna in policarbonato. Dotata di base piana, il fissaggio avviene con viteria standard non fornita.

Caratteristiche luminose

24x LED Bright, in configurazione 6x4, producono tre effetti luminosi: luce fissa, lampeggiante (triplo flash effetto strobo), rotante (effetto rotante che simula perfettamente le luci rotanti tradizionali pur non avendo componenti mobili, permettendo quindi di accrescere enormemente il ciclo di vita del prodotto).

Disponibile con 2 tipi di lente: allCOLOR (lente colorata con fonte luminosa colorata) e allCLEAR (lente neutra con fonte luminosa colorata), vedi pagina 103.

Certificazioni / Certifications



0477



CESI 05 ATEX 043

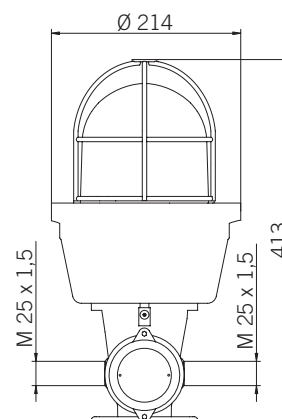
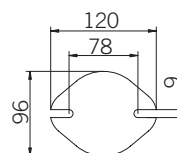

EX 070 FLR S



Medium range explosion-proof integrated LED beacon, EX 070 FLR S is a multifunctional device allowing 3 different light options* (steady, flashing, rotating). This explosion-proof beacon of Group II can be used in areas with explosive atmosphere Zones 1, 2, 21 and 22.

* Please specify the desired light effect when ordering.

Voltages

12/24V ACDC, 40/80V ACDC, 120/240V AC +/-10%

Temperature class

T6

Mechanical features

Housing in copper-free aluminum alloy. Borosilicate glass external dome, polycarbonate internal dome. Provided with flat base. Screw mounting (screws not included).

Optical features

24x Bright LEDs, in a 6x4 configuration, allow three luminous effects: steady light, flashing light (a triple-flash strobe effect), rotating light (a rotating effect perfectly simulating the traditional rotating beacons yet without moving parts, hence enormously enhancing product life time).

Available with 2 different lens types, allCOLOR (colored lens with colored light source) and allCLEAR (clear lens with colored light source), see page 103.



Feu LED antidéflagrant de dimensions moyennes, EX 070 FLR S est un dispositif multifonctionnel qui permet 3 effets lumineux* (lumière fixe, clignotante, tournante). Ce feu antidéflagrant du Groupe II peut être utilisé en atmosphère explosive, zone 1, 2, 21 et 22.

* Spécifier l'effet lumineux souhaité lors de la commande.

Tension d'utilisation

12/24V ACDC, 40/80V ACDC, 120/240V AC +/-10%

Classe de température

T6

Caractéristiques mécaniques

Corps en alliage d'aluminium sans cuivre. Dôme externe en verre borosilicate, dôme interne en polycarbonate. Equipé avec base plate, fixation par vis standards non fournies.

Caractéristiques optiques

24x LED Bright, en configuration 6x4, qui produisent trois effets lumineux : lumière fixe, lumière clignotante (triple-flash, effet stroboscopique) effet tournant, qui simule parfaitement les feux tournants traditionnels sans avoir de composants mobiles, permettant ainsi d'augmenter considérablement la durée de vie du produit.

Disponible avec deux différents types de lentilles : allCOLOR (lentille colorée et source lumineuse colorée) et allCLEAR (lentille incolore transparente avec source lumineuse colorée), voir page 103.

EX 070 SLR S



EX 070 SLR S

Cupole / Domes / Dômes

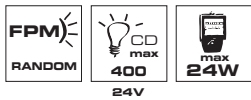

EX 070 SLR S

V ACDC	12 ÷ 24	40 ÷ 80	-
V AC	-	-	120 ÷ 240
mA	450	700	800 250 150 60

Modo di protezione Methods of Protection Mode de protection



II 2G Ex d e IIC T6 Gb
II 2D Ex tb IIIC T85°C Db IP66

Codici / Codes

EX 070 SLR S

12/24V ACDC	95001	95002	95003	95004	95006
40/80V ACDC	97251	97252	97253	97254	97256
120/240V AC	95011	95012	95013	95014	95016

* Specificare la funzione luminosa desiderata al momento dell'ordine.

* Please specify the desired light effect when ordering.

* Spécifier l'effet lumineux souhaité lors de la commande.

Luce a LED integrati antideflagrante di medie dimensioni, EX 070 SLR S è un dispositivo multifunzione che permette 3 funzioni luminose* (luce lampeggiante, luce stroboscopica, luce random). Questa luce antideflagrante del Gruppo II può essere installata in aree con atmosfera esplosiva zona 1, 2, 21 e 22.

* Specificare la funzione luminosa desiderata al momento dell'ordine.

Tensione operativa

12/24V ACDC, 40/80V ACDC, 120/240V AC +/-10%

Classe di temperatura

T6

Caratteristiche meccaniche

Corpo in lega di alluminio esente da rame. Cupola esterna in vetro borosilicato, cupola interna in policarbonato. Dotata di base piana, il fissaggio avviene con viteria standard non fornita.

Caratteristiche luminose

2x LED SuperBright, con lente di Fresnel interna, producono tre effetti luminosi: luce lampeggiante (flash singolo 1F), effetto stroboscopico 5F, luce random (effetto unico nel suo genere con lampeggio casuale che consente di aumentare la capacità del dispositivo di attirare l'attenzione).

Certificazioni / Certifications



0477



CESI 05 ATEX 043

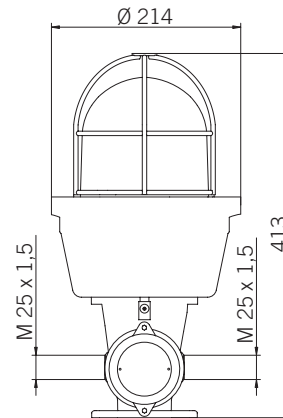
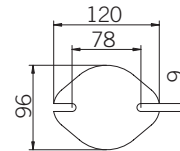

EX 070 SLR S



Medium range explosion-proof integrated LED beacon, EX 070 SLR S is a multifunctional device allowing 3 different light options* (flashing, strobe, random). This explosion-proof beacon of Group II can be used in areas with explosive atmosphere Zones 1, 2, 21 and 22.

* Please specify the desired light effect when ordering.

Voltagges

12/24V ACDC, 40/80V ACDC, 120/240V AC +/-10%

Temperature class

T6

Mechanical features

Housing in copper-free aluminum alloy. Borosilicate glass external dome, polycarbonate internal dome. Provided with flat base. Screw mounting (screws not included).

Optical features

2x SuperBright LEDs, with inner Fresnel lens, allow three luminous effects: flashing light (single flash 1F), 5F strobe effect, random light (a unique random effect consisting in an uneven flashing pattern, augmenting the ability of catching attention).



Feu LED antidéflagrant de dimensions moyennes, EX 070 SLR S est un dispositif multifonctionnel qui permet 3 effets lumineux* (lumière clignotante, effet stroboscopique, effet random). Ce feu antidéflagrant du Groupe II peut être utilisé en atmosphère explosive, zone 1, 2, 21 et 22.

* Spécifier l'effet lumineux souhaité lors de la commande.

Tension d'utilisation

12/24V ACDC, 40/80V ACDC, 120/240V AC +/-10%

Classe de température

T6

Caractéristiques mécaniques

Corps en alliage d'aluminium sans cuivre. Dôme externe en verre borosilicate, dôme interne en polycarbonate. Equipé avec base plate, fixation par vis standards non fournies.

Caractéristiques optiques

2x LED SuperBright avec lentille de Fresnel à l'intérieur, produisent trois effets lumineux: lumière clignotante (simple éclat 1F), effet stroboscopique 5F, effet random (consistant en un clignotement aléatoire, qui permet au dispositif d'augmenter la capacité d'attirer l'attention).

EX 0100 STF 15J



EX 0100 STF 15J

Cupole / Domes / Dômes

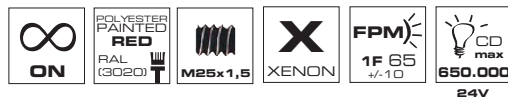
EXTERNAL INTERNAL
DOME DOME

EX 0100 STF 15J

V DC	12 ÷ 24	-
V AC	-	240
A	2,5, 1,2	0,15

Modo di protezione
Methods of Protection
Mode de protection



II 2G Ex d e IIC T6 Gb
II 2D Ex tb IIIC T85°C Db IP66

Codici / Codes

EX 0100 STF 15J

12/24V DC
240V AC

96552	96553	96556
96572	96573	96576

Luce a scarica di Xenon antideflagrante di grandi dimensioni, EX 0100 STF è dotato di circuito elettronico che garantisce elevata visibilità grazie al potente flash da 15J. Questa luce antideflagrante del Gruppo II può essere installata in aree con atmosfera esplosiva zona 1, 2, 21 e 22.

Tensione operativa

12/24V DC, 240V AC +/-10%

Classe di temperatura

T6

Caratteristiche meccaniche

Corpo in lega di alluminio esente da rame. Cupola esterna in vetro borosilicato, cupola interna in policarbonato. Dotata di base piana, il fissaggio avviene con viteria standard non fornita.

Caratteristiche luminose

Lampada a scarica di Xenon da 15J e cupola a lente di Fresnel garantiscono un potente flash singolo 1F.

Certificazioni / Certifications

0477



CESI 05 ATEX 043

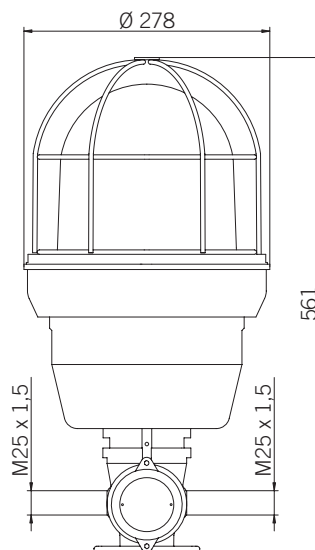
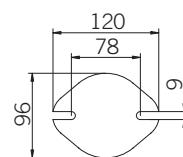

EX 0100 STF 15J



Large size explosion-proof Xenon flashing beacon, EX 0100 STF is fitted with a specifically designed circuit that guarantees high light output thanks to the powerful 15J flash. This explosion-proof beacon of Group II can be used in areas with explosive atmosphere Zones 1, 2, 21 and 22.

Voltages

12/24V DC, 240V AC +/-10%

Temperature class

T6

Mechanical features

Housing in copper-free aluminum alloy. Borosilicate glass external dome, polycarbonate internal dome. Provided with flat base. Screw mounting (screws not included).

Optical features

15J Xenon discharge tube and the inner Fresnel lens guarantee a powerful single flash 1F.



Feu au Xénon antidéflagrant de grandes dimensions, EX 0100 STF est équipé avec un circuit électronique qui garantit une haute visibilité grâce au tube à décharge Xénon 15J. Ce feu antidéflagrant du Groupe II peut être utilisé en atmosphère explosive, zone 1, 2, 21 et 22.

Tension d'utilisation

12/24V DC, 240V AC +/-10%

Classe de température

T6

Caractéristiques mécaniques

Corps en alliage d'aluminium sans cuivre. Dôme externe en verre borosilicate, dôme interne en polycarbonate. Equipé avec base plate, fixation par vis standards non fournies.

Caractéristiques optiques

Le tube à décharge au Xénon 15J et le dôme à lentille de Fresnel garantissent un puissant flash simple éclat 1F.

EX 080 RA-RA H



EX 080 RA
EX 080 RA H
(versione alogena
halogen version
version halogène)

Cupole / Domes / Dômes



AL	PYREX	PC	50/60 Hz	-25 +50 C°	-20 +40 C°
EXTERNAL DOME		INTERNAL DOME			
IP66	M25x1,5	POLYESTER PAINTED RED	RAL (GG20)	ON	
EX 080 RA					
Ba 15s	E 14	RPM 160	CD max 1600	max 45W	
DC	AC	24V			
EX 080 RA H					
H1	RPM 160	CD max 4500	max 55W	max 70W	
	24V		12V	24V	

EX 080 RA				EX 080 RA H		
V DC	12	24	-	V DC	12	24
V AC	12	24	110	V AC	12	24
A	4	2,1	0,27	A	4,8	3,1

Modo di protezione / Methods of Protection / Mode de protection

II 2G Ex d e IIC T6 Gb
II 2D Ex tb IIIC T85°C Db IP66

Codici / Codes

EX 080 RA

12V DC	95941	95942	95943	95944	95945
12V AC	95951	95952	95953	95954	95955
24V DC	95961	95962	95963	95964	95965
24V AC	95971	95972	95973	95974	95975
110V AC	96001	96002	96003	96004	96005
240V AC	96011	96012	96013	96014	96015

EX 080 RA H

12V DC	96021	96022	96023	96024	96025
12V AC	96031	96032	96033	96034	96035
24V DC	96041	96042	96043	96044	96045
24V AC	96051	96052	96053	96054	96055

Luce rotante antideflagrante di grandi dimensioni, disponibile in versione con lampada a filamento **EX 080 RA** o alogena di tipo H1 **EX 080 RA H**. Questa luce antideflagrante del Gruppo II può essere installata in aree con atmosfera esplosiva zona 1, 2, 21 e 22.

Tensione operativa

EX 080 RA: 12V DC, 12V AC, 24V DC, 24V AC, 110V AC, 240V AC +/-10%
EX 080 RA H: 12V DC, 12V AC, 24V DC, 24V AC +/-10%

Classe di temperatura

T6

Caratteristiche meccaniche

Corpo in lega di alluminio esente da rame. Cupola esterna in vetro borosilicato, cupola interna in polycarbonato. Dotata di base piana, il fissaggio avviene con viteria standard non fornita.

Caratteristiche luminose

EX 080 RA: luce rotante con specchio in alluminio anodizzato e lampada BA 15s 45W (12V AC o DC e 24V AC o DC) oppure lampada E14 25W (110V AC e 240V AC).

EX 080 RA H: luce rotante con specchio in alluminio anodizzato e lampada alogena H1 da 55W (12V) o 70W (24V)

Certificazioni / Certifications

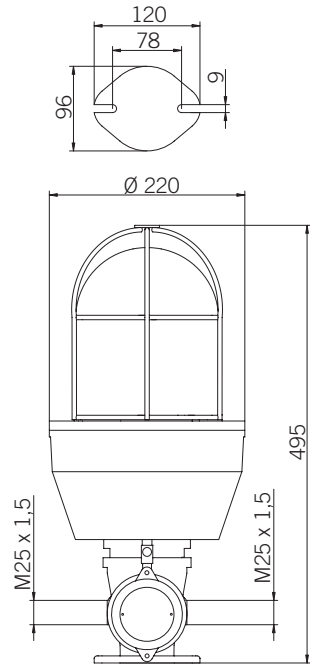

EX 080 RA
EX 080 RA H
 7,42



Large size explosion-proof rotating beacon with either a filament bulb **EX 080 RA** or halogen type H1 bulb **EX 080 RA H**. This explosion-proof beacon of Group II can be used in areas with explosive atmosphere Zones 1, 2, 21 and 22.

Voltages

EX 080 RA: 12V DC, 12V AC, 24V DC, 24V AC, 110V AC, 240V AC +/-10%
EX 080 RA H: 12V DC, 12V AC, 24V DC, 24V AC +/-10%

Temperature class

T6

Mechanical features

Housing in copper-free aluminum alloy. Borosilicate glass external dome, polycarbonate internal dome. Provided with flat base. Screw mounting (screws not included).

Optical features

EX 080 RA: rotating beacon with anodized aluminium reflector and BA 15s 45W bulb (12V AC or DC and 24V AC or DC) or E14 25W bulb (110V AC and 240V AC).
EX 080 RA H: rotating beacon with anodized aluminium reflector and H1 55W (12V) or 70W (24V) halogen bulb.



Feu tournant antidéflagrant de grandes dimensions, disponible en version avec ampoule a filament **EX 080 RA** ou avec ampoule halogène H1 **EX 080 RA H**. Ce feu antidéflagrant du Groupe II peut être utilisé en atmosphère explosive, zone 1, 2, 21 et 22.

Tension d'utilisation

EX 080 RA : 12V DC, 12V AC, 24V DC, 24V AC, 110V AC, 240V AC +/-10%
EX 080 RA H : 12V DC, 12V AC, 24V DC, 24V AC +/-10%

Classe de température

T6

Caractéristiques mécaniques

Corps en alliage d'aluminium sans cuivre. Dôme externe en verre borosilicate, dôme interne en polycarbonate. Equipé avec base plate, fixation par vis standards non fournies.

Caractéristiques optiques

EX 080 RA : feu tournant avec réflecteur en aluminium anodisé et ampoule BA 15s 45W (12V AC ou DC et 24V AC ou DC) ou ampoule E14 25W (110V AC et 240V AC).
EX 080 RA H : feu tournant avec réflecteur en aluminium anodisé et ampoule halogène H1 55W (12V) ou 70W (24V).

EX 080 LA-LA H



EX 080 LA F
EX 080 LA L
EX 080 LA L H
(versione alogena
halogen version
version halogène)

Cupole / Domes / Dômes

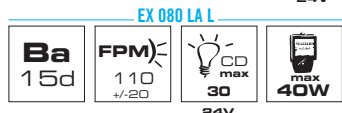
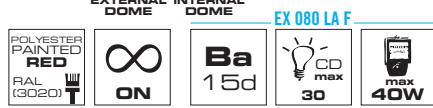

EX 080 LA F

V ACDC	12	24	48	110	240
A	3,3	1,65	0,83	0,36	0,17

EX 080 LA L					EX 080 LA L H			
V DC	12	24	48	-	-	V DC	12	24
V AC	-	24	48	110	240	V AC	12	24
A	3,4	1,7	0,83	0,36	0,17	A	4,6	2,9

Modo di protezione / Methods of Protection / Mode de protection

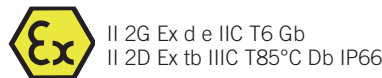

Luce fissa EX 080 LA F o lampeggiante EX 080 LA L antideflagrante di grandi dimensioni, con lampada a filamento. Disponibile anche con lampada alogena di tipo H1 EX 080 LA L H. Questa luce antideflagrante del Gruppo II può essere installata in aree con atmosfera esplosiva zona 1, 2, 21 e 22.

Tensione operativa

EX 080 LA F: 12V ACDC, 24V ACDC, 48V ACDC, 110V ACDC, 240V ACDC +/-10%
EX 080 LA L: 12V DC, 24V DC, 24V AC, 48V DC, 48V AC, 110V AC, 240V AC +/-10%
EX 080 LA L H: 12V DC, 12V AC, 24V DC, 24V AC +/-10%

Classe di temperatura

T6

Caratteristiche meccaniche

Corpo in lega di alluminio esente da rame. Cupola esterna in vetro borosilicato, cupola interna in policarbonato. Dotata di base piana, il fissaggio avviene con viteria standard non fornita.

Caratteristiche luminose

EX 080 LA F: luce fissa con lampada a filamento Ba 15d da 40W
EX 080 LA L: luce lampeggiante con lampada a filamento Ba 15d da 40W
EX 080 LA L H: luce lampeggiante con lampada alogena H1 da 55W (12V) o 70W (24V)

Certificazioni / Certifications

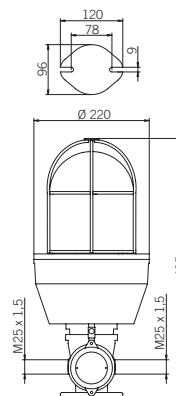

EX 080 LA F
EX 080 LA L
EX 080 LA L H



Large size explosion-proof steady light EX 080 LA F or flashing light EX 080 LA L beacon with filament bulb. Also available with halogen type H1 bulb EX 080 LA L H. This explosion-proof beacon of Group II can be used in areas with explosive atmosphere Zones 1, 2, 21 and 22.



Feu fixe EX 080 LA F ou clignotant EX 080 LA L antidéflagrant de grandes dimensions, avec ampoule a filament. Disponible aussi avec ampoule halogène H1 EX 080 LA L H. Ce feu antidéflagrant du Groupe II peut être utilisé en atmosphère explosive, zone 1, 2, 21 et 22.

Voltages

EX 080 LA F: 12V ACDC, 24V ACDC, 48V ACDC, 110V ACDC, 240V ACDC +/-10%
EX 080 LA L: 12V DC, 24V DC, 24V AC, 48V DC, 48V AC, 110V AC, 240V AC +/-10%
EX 080 LA L H: 12V DC, 12V AC, 24V DC, 24V AC +/-10%

Tension d'utilisation

EX 080 LA F: 12V ACDC, 24V ACDC, 48V ACDC, 110V ACDC, 240V ACDC +/-10%
EX 080 LA L: 12V DC, 24V DC, 24V AC, 48V DC, 48V AC, 110V AC, 240V AC +/-10%
EX 080 LA L H: 12V DC, 12V AC, 24V DC, 24V AC +/-10%

Temperature class

T6

Classe de température

T6

Mechanical features

Housing in copper-free aluminum alloy. Borosilicate glass external dome, polycarbonate internal dome. Provided with flat base. Screw mounting (screws not included).

Caractéristiques mécaniques

Corps en alliage d'aluminium sans cuivre. Dôme externe en verre borosilicate, dôme interne en polycarbonate. Equipé avec base plate, fixation par vis standards non fournies.

Optical features

EX 080 LA F: steady light with 40W Ba 15d incandescent lamp
EX 080 LA L: flashing light with 40W Ba 15d incandescent lamp
EX 080 LA L H: flashing light with H1 55W (12V) or 70W (24V) halogen bulb

Caractéristiques optiques

EX 080 LA F: lumière fixe avec ampoule à incandescence Ba 15d 40W
EX 080 LA L: lumière clignotante avec ampoule à incandescence Ba 15d 40W
EX 080 LA L H: lumière clignotante avec ampoule halogène H1 55W (12V) ou 70W (24V)

Codici / Codes

EX 080 LA F

12V ACDC	96171	96172	96173	96174	96175
24V ACDC	96181	96182	96183	96184	96185
48V ACDC	96191	96192	96193	96194	96195
110V ACDC	96201	96202	96203	96204	96205
240V ACDC	96211	96212	96213	96214	96215

EX 080 LA L

12V DC	96061	96062	96063	96064	96065
24V DC	96071	96072	96073	96074	96075
24V AC	96081	96082	96083	96084	96085
48V DC	96091	96092	96093	96094	96095
48V AC	96101	96102	96103	96104	96105
110V AC	96111	96112	96113	96114	96115
240V AC	96121	96122	96123	96124	96125

EX 080 LA L H

12V DC	96131	96132	96133	96134	96135
12V AC	96141	96142	96143	96144	96145
24V DC	96151	96152	96153	96154	96155
24V AC	96161	96162	96163	96164	96165

EX 025 PAG EX 045 LD PAG SP



EX 025 PAG



EX 045 LD PAG SP

Cupole / Domes / Dômes EX 045 LD PAG SP



EX 045 LD PAG SP

V ACDC	12	24	48	-	-
V AC	-	-	-	110	240
mA	27	20	20	17	18

Modo di protezione
Methods of Protection
Mode de protection



II 2GD
Ex d IIC T6 Gb
Ex tb IIIC T85°C Db IP66

Codici / Codes

EX 025 PAG 96699

EX 045 LD PAG SP

12V ACDC	97051	97052	97053	97054	97055	97056
24V ACDC	97061	97062	97063	97064	97065	97066
48V ACDC	97071	97072	97073	97074	97075	97076
110V AC	97081	97082	97083	97084	97085	97086
240V AC	97091	97092	97093	97094	97095	97096

EX 025 PAG - Interruttore di emergenza antideflagrante, ideale per l'attivazione di sistemi di allarme in ambienti con atmosfera esplosiva. Garantisce sicurezza e durabilità nel tempo.
EX 045 LD PAG SP - Spia luminosa antideflagrante, ideale per la segnalazione del corretto funzionamento dei sistemi di allarme o allertamento installati in ambienti con atmosfera esplosiva.

Questi dispositivi del Gruppo II possono essere installati in aree con atmosfera esplosiva zona 1, 2, 21 e 22.

Tensione operativa

EX 025 PAG: 10A - 240V

EX 045 LD PAG SP: 12V ACDC, 24V ACDC, 48V ACDC, 110V AC, 240V AC +/-10%

Classe di temperatura

T6

Caratteristiche meccaniche

Corpo in lega di alluminio esente da rame. Componente in vetro (EX 025 PAG). Cupola in polycarbonato (EX 045 LD PAG SP). Fissaggio con viteria standard non fornita.

Caratteristiche luminose

EX 045 LD PAG SP: lampada a LED (LD044F) con attacco Ba 9s

Certificazioni / Certifications



0477



CESI 05 ATEX 062

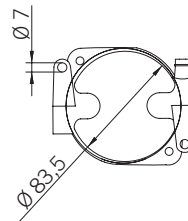
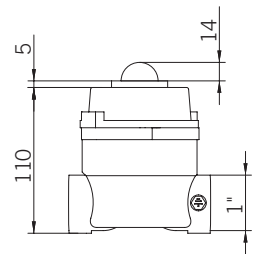
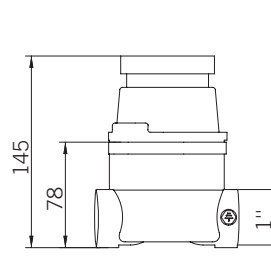

EX 025 PAG

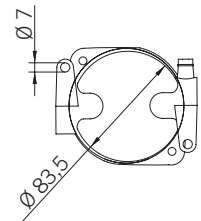

EX 045 LD PAG SP



EX 025 PAG - Explosion-proof emergency switch, ideal for activating alarm systems in explosive atmospheres, guaranteeing safety and long lifetime.
EX 045 LD PAG SP - Explosion-proof pilot light, ideal for signaling the correct functioning of alarm/warning systems in explosive atmospheres.

These explosion-proof devices of Group II can be used in areas with explosive atmosphere Zones 1, 2, 21 and 22.

Voltages

EX 025 PAG: 10A - 240V

EX 045 LD PAG SP: 12V ACDC, 24V ACDC, 48V ACDC, 110V AC, 240V AC +/-10%

Temperature class

T6

Mechanical features

Housing in copper-free aluminum alloy. Glass component (EX 025 PAG). Polycarbonate dome (EX 045 LD PAG SP). Screw mounting (screws not included).

Optical features

EX 045 LD PAG SP: Ba 9s LED bulb (LD044F).



EX 025 PAG - Bouton poussoir d'urgence antidéflagrant, adapté pour activer systèmes d'alarme dans les environnements avec atmosphère explosive.

EX 045 LD PAG SP - Voyant lumineux antidéflagrant, adapté pour la signalisation du fonctionnement correct des systèmes d'alarme dans les environnements avec atmosphère explosive.

Ces dispositifs du Groupe II peuvent être utilisés en atmosphère explosive, zone 1, 2, 21 et 22.

Tension d'utilisation

EX 025 PAG: 10A - 240V

EX 045 LD PAG SP: 12V ACDC, 24V ACDC, 48V ACDC, 110V AC, 240V AC +/-10%

Classe de température

T6

Caractéristiques mécaniques

Corps en alliage d'aluminium sans cuivre. Composant en verre (EX 025 PAG). Dôme en polycarbonate (EX 045 LD PAG SP). Fixation par vis standards non fournies.

Caractéristiques optiques

EX 045 LD PAG SP: ampoules à LED (LD044F), culot Ba 9s.

LAMPADE RICAMBIO

SPARE BULBS

AMPOULES DE RECHANGE



BA 15d

40W

scatola: box: boîte :	1x12 pz. 1x12 pcs. 1x12 pcs.	singola single individuelle	12 pz. 12 pcs. 12 pcs.
12V	70985	70956	72745
24V	70986	70957	72746
48V	70987	70958	72747
110V	70988	70959	72748
240V	70989	70960	72749

EX 080 LA F, EX 080 LA L



BA 15s

45W

per versioni DC
for DC versions
pour versions DC

12V	71600
24V	71601

EX 080 RA



E14T

25W

per versioni AC
for AC versions
pour versions AC

110V	71625
240V	71640

EX 080 RA



H1

12V (55W)	71602
24V (70W)	71603

EX 080 RA H, EX 080 LA L H



XENON

15J	71638
-----	-------

EX 0100 STF



NORMATIVE E SPECIFICHE TECNICHE

La gamma *EXPRO* Sirena è progettata in accordo con la Direttiva ATEX 2014/34/EU, relativa ad apparecchiature destinate a essere utilizzate in atmosfera potenzialmente esplosiva per la presenza di gas e/o polveri combustibili.

Il 29 marzo 2014, la nuova Direttiva ATEX è stata pubblicata sulla Gazzetta Ufficiale dell'Unione Europea, prende il nome di ATEX 2014/34/UE e va ad abrogare, con effetto decorrente dal 20 aprile 2016, la Direttiva ATEX 94/9/CE. Riguarda l'armonizzazione delle legislazioni degli stati membri e ha come obiettivo quello di garantire la libera circolazione nel territorio UE dei prodotti ai quali si applica.

La revisione della direttiva non ha comportato stravolgimenti sostanziali per quanto riguarda gli aspetti tecnici; le principali modifiche apportate riguardano la posizione giuridica degli operatori economici della filiera quali, i rappresentanti autorizzati, il distributore, l'importatore e il produttore, al fine di migliorare la credibilità del marchio CE.

Dal punto di vista tecnico è necessario continuare a considerare quanto definito dalle direttive 94/9/CE (ATEX 95) e 1999/92/CE (ATEX 137), in altre parole classificare le zone di pericolo d'esplosione e le relative apparecchiature.

Un'atmosfera potenzialmente esplosiva è un'atmosfera composta da una miscela di aria e sostanze infiammabili sotto forma di gas, vapori, nebbie o polveri nella quale, dopo l'innesco, la combustione si propaga all'intera miscela infiammabile.

La principale differenza tra un'atmosfera "gassosa" e una "polverosa" è la massa per unità di volume; quella dei gas e vapori è circa mille volte inferiore a quella delle polveri. Inoltre i gas si disperdono nell'aria per convezione e diffusione, per formare un'atmosfera omogenea. Le polveri sono molto più pesanti dell'aria e si depositano più velocemente.

Al fine di operare la scelta e l'installazione corretta delle apparecchiature elettriche destinate ad ambienti con atmosfere potenzialmente esplosive, è necessario analizzare e classificare tali luoghi.

I riferimenti normativi sono i seguenti:

1. Classificazione dei luoghi:

- IEC 60079-10-1

"Atmosfere esplosive - Parte 10-1: Classificazione dei luoghi.
Atmosfere esplosive per la presenza di gas"

- IEC 60079-10-2

"Atmosfere esplosive - Parte 10-2: Classificazione dei luoghi.
Atmosfere esplosive per la presenza di polveri combustibili"

2. Scelta ed installazione delle apparecchiature:

- IEC 60079-14

"Atmosfere esplosive - Parte 14: Progettazione, scelta e installazione degli impianti elettrici"



NORMATIVES AND TECHNICAL SPECIFICATIONS

Sirena's *EXPRO* range has been engineered according to ATEX Directive 2014/34/EU, relating to electrical equipment to be used in zones with potentially explosive atmospheres due to the presence of gas and/or combustible dust.

On March 29th 2014, the new ATEX Directive was published in the Official Journal of the European Union. It represents an update in the regulatory scenery of the equipment that can be used in areas with a potentially explosive atmosphere.

The new Directive of the 26th of February 2014 is called ATEX 2014/34/EU and goes to repeal, with effect from the 20th April 2016, the present ATEX Directive 94/9/EC. It mainly regards the harmonization of the laws of the Member States and aims to ensure free circulation within the EU of products to which it applies.

The main changes concern the legal situation of economic operators such as the legal representative, the distributor, the importer and the manufacturer.

The Directive ensures continuity with the substantial provisions of the previous Directive and does not regulate the use of equipment in a potentially explosive atmosphere, which is covered by Directive 94/9/EC (ATEX 95) and 1999/92/EC (ATEX 137).

An explosive atmosphere is defined as a mixture of inflammable substances (gas, vapors, mists or dusts) with air, where if an ignition has occurred, combustion spreads to the entire inflammable mixture.

The main difference between "gaseous" and "dusty" atmosphere is the mass per volume unit; that of gases and vapors is about a thousand times lower than that of the powders. In addition, the gases disperse in the air by convection and diffusion, to form a homogeneous atmosphere. Dusts are much heavier than air and deposit faster.

In order to conform with the provisions of the Directive and to install the correct electrical equipment for use in potentially explosive atmospheres, it is necessary to classify the hazardous areas.

Reference standards are the following:

1. Hazardous areas classification:

- **IEC 60079-10-1**
"Explosive atmospheres - Part 10-1: Classification of areas. Explosive gas atmospheres"
- **IEC 60079-10-2**
"Explosive atmospheres - Part 10-2: Classification of areas. Combustible dusts atmospheres"

2. Equipment choice:

- **IEC 60079-14**
"Explosive atmospheres Part 14: Electrical installations design, selection and erection"



NORMES ET SPECIFICATIONS TECHNIQUES

La gamme de produits *EXPRO* de Sirena a été développée en accord avec les directives ATEX 2014/34/EU relatives aux équipements électriques installés en zones à atmosphères explosives gazeuses et/ou poussiéreuses.

Le 29 Mars 2014, de nouvelles directives ATEX ont été publiées dans le journal officiel de l'Union européenne. Ces nouvelles directives sont relatives à l'harmonisation des législations des Etats membres concernant les appareils et les systèmes de protection destinés à être utilisés en atmosphères explosibles.

Les principaux changements sont liés aux responsabilités relatives à la mise sur le marché des produits par les fabricants, les importateurs et les distributeurs.

Une atmosphère explosive est un mélange avec l'air, dans des conditions atmosphériques, de substances inflammables sous forme de gaz, vapeurs, poussières ou de fibres dans lequel, après inflammation, la combustion se propage à l'ensemble du mélange non brûlé.

Une atmosphère explosive peut être formée dans plusieurs industries telles que : la pétrochimie, moulins et silos générant des poussières combustibles, dans le secteur minier par le gaz méthane et la poussière de charbon. D'autres domaines peuvent développer des atmosphères explosives tels que : l'industrie de la peinture, du recyclage ou la production de biogaz.

Dès lors qu'une atmosphère explosive subsiste, certains niveaux de sécurité doivent être pris en compte au regard du danger potentiel que constitue une explosion. Par conséquent, ces lieux doivent être divisés en zones en fonction de la présence de substances inflammables:

1. Classification des emplacements :

- **CEI-EN 60079-10-1**
"Atmosphères explosives - Partie 10-1: Classification des emplacements. Atmosphères explosives gazeuses"
- **CEI-EN 60079-10-2**
"Atmosphères explosives - Partie 10-2: Classification des emplacements. Atmosphères explosives poussiéreuses"

2. Choix de l'équipement :

- **CEI-EN 60079-14**
"Atmosphères explosives - Partie 14: sélection et construction des installations électriques"

1. Classificazione dei luoghi Hazardous areas classification Classification des emplacements

Classificazione delle aree pericolose in base alla natura delle sostanze pericolose: Gruppi di apparecchi - Categorie - Zone

 Hazardous areas classification according to the nature of hazardous substances: Groups - Categories - Zones

 Classification des emplacements en fonction de la nature des substances explosives : Groupes - Catégories - Zones

Impianti non di superficie (miniere) / Non-surface equipment (mines) / Matériel destiné aux mines grisouteuses

CATEGORIE di PERICOLO (secondo il livello di rischio) CATEGORIES (according to the level of risk) / CATEGORIES (en fonction du niveau de risque)			
GRUPPO GROUP GROUPE I	<table border="1"> <tr> <td style="vertical-align: top;"> Categoria M1 / Category M1 / Catégorie M1 Costante presenza di grisou o polvere di carbone Constant presence of firedamp or slack Présence constante de méthane, poussières </td> <td style="vertical-align: top;"> Categoria M2 / Category M2 / Catégorie M2 Probabile presenza di grisou o polvere di carbone Probable presence of firedamp or slack Risque de présence de méthane, poussières </td> </tr> </table>	Categoria M1 / Category M1 / Catégorie M1 Costante presenza di grisou o polvere di carbone Constant presence of firedamp or slack Présence constante de méthane, poussières	Categoria M2 / Category M2 / Catégorie M2 Probabile presenza di grisou o polvere di carbone Probable presence of firedamp or slack Risque de présence de méthane, poussières
Categoria M1 / Category M1 / Catégorie M1 Costante presenza di grisou o polvere di carbone Constant presence of firedamp or slack Présence constante de méthane, poussières	Categoria M2 / Category M2 / Catégorie M2 Probabile presenza di grisou o polvere di carbone Probable presence of firedamp or slack Risque de présence de méthane, poussières		

Impianti di superficie (altre aree a rischio diverse da miniere) / Equipment for Surface Installations (non-mining surface installations) Matériel destiné à des lieux soumis aux atmosphères explosives autres que les mines grisouteuses

		ZONE di PERICOLO / DANGEROUS ZONES / ZONES DANGEREUSES					
GRUPPO GROUP GROUPE II gas (G) gaz (G)	IIA* Gas tipico: Propane Representative Gas: Propane Gaz représentatif : Propane MESG > 0,9 mm MIC > 0,8 mm	IIB* Gas tipico: Etilene Representative Gas: Ethylene Gaz représentatif: Éthylène MESG da/from/de 0,5 mm a/to/à 0,9 mm MIC da/from/de 0,45 mm a/to/à 0,8 mm	IIC* Gas tipico: Idrogeno e Acetilene Representative Gas: Hydrogen and Acetylene Gaz représentatif: Hydrogène et Acétylène MESG > 0,5 mm MIC > 0,45	Zona / Zone 0 L'atmosfera esplosiva è presente continuamente o per lunghi periodi o frequentemente Area in which an explosive atmosphere, is present permanently or for long periods or often Présence de l'atmosphère explosive permanente , fréquente ou pendant de longues périodes	Zona / Zone 1 L'atmosfera esplosiva è probabile che sia presente occasionalmente durante il funzionamento normale Area in which occasionally during normal activities the formation of an explosive atmosphere, is possible Présence de l'atmosphère explosive intermittente en service normal (probable)	Zona / Zone 2 L'atmosfera esplosiva non è probabile che sia presente durante il funzionamento normale, ma se ciò avvenisse, è possibile che persista solo per brevi periodi Area in which occasionally during normal activities the formation of an explosive atmosphere, is not possible , and in case it happens, it lasts very shortly Présence de l'atmosphère explosive épisodique ou pendant de courtes périodes (jamais en service normal)	
GRUPPO GROUP GROUPE III polveri (D) dusts (D) poussières (D)	IIIA Particelle combustibili Flammable Particles Substances Inflammables	IIIB Polveri non conduttive Non-conductive dust Poussière non-conductrice	IIIC Polveri conduttive Conductive dust Poussière conductrice	Zona / Zone 20 L'atmosfera esplosiva è presente continuamente o per lunghi periodi o frequentemente Area in which an explosive atmosphere, is present permanently or for long periods or often Présence de l'atmosphère explosive permanente , fréquente ou pendant de longues périodes	Zona / Zone 21 L'atmosfera esplosiva è probabile che sia presente occasionalmente durante il funzionamento normale Area in which occasionally during normal activities the formation of an explosive atmosphere, is possible Présence de l'atmosphère explosive intermittente en service normal (probable)	Zona / Zone 22 L'atmosfera esplosiva non è probabile che sia presente durante il funzionamento normale, ma se ciò avvenisse, è possibile che persista solo per brevi periodi Area in which occasionally during normal activities the formation of an explosive atmosphere, is not possible , and in case it happens, it lasts very shortly Présence de l'atmosphère explosive épisodique ou pendant de courtes périodes (jamais en service normal)	

* La suddivisione in tre sottogruppi A, B e C è in funzione della natura del gas stesso, dell'interstizio sperimentale massimo di sicurezza (MESG) e dell'energia minima di accensione del gas (MIC).

Il gruppo IIC è il più restrittivo, infatti le apparecchiature IIC sono idonee anche per i gruppi IIB e IIA, quelle del gruppo IIB sono idonee per il gruppo IIA ma non per il gruppo IIC.

 The division in three subgroups A, B and C is according to the nature of the gas itself and in relation to a parameter defined maximum experimental safe gaps (MESG) and the minimum ignition energy of a gas (MIC).

IIC Group is the highly dangerous group, it means that a device in Group IIC is also suitable for groups IIB and IIA, a device in group IIB is suitable for group IIA but not for group IIC.

 La division en 3 sous-groupes A, B et C est relative à la nature du gaz et est basée pour le mode "d" sur l'Interstice Expérimentale Maximale de Sécurité (IEMS) et pour le mode "i" sur le Courant Minimal d'Inflammation (CMI).

Le matériel marqué IIB convient pour des applications exigeant des matériels du groupe IIA. De même IIC convient pour IIA et IIB.

2. Scelta delle apparecchiature Equipment choice Choix de l'équipement

- Correlazione tra le zone di pericolo e le categorie delle apparecchiature
- Correlation between dangerous zones and equipment categories
- Corrélation entre zones dangereuses et catégories d'équipement

Impianti di superficie (altre aree a rischio diverse da miniere)

Equipment for Surface Installations (non-mining surface installations) / Equipement installé en surface

<p>ZONE DI PERICOLO DANGEROUS ZONES ZONES DANGEREUSES</p> <p>II</p> <p>gas (G) gaz (G)</p>	<p>Zona / Zone 0</p> <p>L'atmosfera esplosiva è presente continuamente o per lunghi periodi o frequentemente</p> <p>Area in which an explosive atmosphere, is present permanently or for long periods or often</p> <p>Présence de l'atmosphère explosive permanente, fréquente ou pendant de longues périodes</p>	<p>Zona / Zone 1</p> <p>L'atmosfera esplosiva è probabile che sia presente occasionalmente durante il funzionamento normale</p> <p>Area in which occasionally during normal activities the formation of an explosive atmosphere, is possible</p> <p>Présence de l'atmosphère explosive intermittente en service normal (probable)</p>	<p>Zona / Zone 2</p> <p>L'atmosfera esplosiva non è probabile che sia presente durante il funzionamento normale, ma se ciò avvenisse, è possibile che persista solo per brevi periodi</p> <p>Area in which occasionally during normal activities the formation of an explosive atmosphere, is not possible, and in case it happens, it lasts very shortly</p> <p>Présence de l'atmosphère explosive épisodique ou pendant de courtes périodes (jamais en service normal)</p>
<p>CATEGORIE APPARECHIATURE EQUIPMENT CATEGORIES CATEGORIE D'EQUIPEMENT</p>	<p>1G</p>	<p>2G oppure / or / ou 1G</p>	<p>3G oppure / or / ou 2G oppure / or / ou 1G</p>

<p>ZONE DI PERICOLO DANGEROUS ZONES ZONES DANGEREUSES</p> <p>III</p> <p>polveri (D) dusts (D) poussières (D)</p>	<p>Zona / Zone 20</p> <p>L'atmosfera esplosiva è presente continuamente o per lunghi periodi o frequentemente</p> <p>Area in which an explosive atmosphere, is present permanently or for long periods or often</p> <p>Présence de l'atmosphère explosive permanente, fréquente ou pendant de longues périodes</p>	<p>Zona / Zone 21</p> <p>L'atmosfera esplosiva è probabile che sia presente occasionalmente durante il funzionamento normale</p> <p>Area in which occasionally during normal activities the formation of an explosive atmosphere, is possible</p> <p>Présence de l'atmosphère explosive intermittente en service normal (probable)</p>	<p>Zona / Zone 22</p> <p>L'atmosfera esplosiva non è probabile che sia presente durante il funzionamento normale, ma se ciò avvenisse, è possibile che persista solo per brevi periodi</p> <p>Area in which occasionally during normal activities the formation of an explosive atmosphere, is not possible, and in case it happens, it lasts very shortly</p> <p>Présence de l'atmosphère explosive épisodique ou pendant de courtes périodes (jamais en service normal)</p>
<p>CATEGORIE APPARECHIATURE EQUIPMENT CATEGORIES CATEGORIE D'EQUIPEMENT</p>	<p>1D</p>	<p>2D oppure / or / ou 1D</p>	<p>3D oppure / or / ou 2D oppure / or / ou 1D</p>



Esempio di impianto di superficie con zone di pericolo per la presenza di **GAS**
Surface Installation example for dangerous zone in presence of **GAS**
Exemple d'installation en surface dans une atmosphère explosive **GAZEUSE**

Esempio di impianto di superficie con zone di pericolo per la presenza di **POLVERI**
Surface Installation example for dangerous zone in presence of **DUSTS**
Exemple d'installation en surface dans une atmosphère explosive **POUSSIÈREUSE**

3. EPL Livello di Protezione delle Apparecchiature Equipment Protection Level Niveaux de Protection du Matériel

Nella norma IEC 60079-14 è stata coniata l'espressione Livello di Protezione delle Apparecchiature (**EPL** Equipment Protection Level). Gli EPL indicano il livello di protezione offerto da un'apparecchiatura e identificano l'idoneità di base di quest'ultima per una zona specifica.

- IEC 60079-14 standard introduced a method for risk assessment that considers the equipment levels of protection (**EPL**). EPL indicates the risk of ignition intrinsic to the equipment, independently from the type of protection adopted.
- CEI 60079-14 : Niveau de protection assigné à un matériel basé sur son propre risque de devenir une source d'inflammation, distinguant les différences entre atmosphères explosibles de type gaz, poussières et les atmosphères qui peuvent exister dans les mines souterraines.

4. Modi di protezione Protection types Types de protection

I modi di protezione fanno riferimento alle norme di progettazione per i dispositivi da utilizzare in aree pericolose per la presenza di atmosfera potenzialmente esplosiva con: GAS (G) e POLVERI (D). Di seguito le zone assegnate ai valori **EPL** e i relativi MODI DI PROTEZIONE:

- The protection types are design measures and electrical measures carried out on the equipment to achieve explosion protection in the areas subject to explosion hazard due to GAS (G) or DUSTS (D). Set out below, correlation between installation areas and **EPL** values and relevant PROTECTION TYPES:
- Ci-dessous les différents modes de protection pour un matériel électrique en atmosphère explosive par la présence de GAZ (G) ou POUSSIERES (D) et la corrélation entre **EPL** et les MODES DE PROTECTION :

4a. MINIERE - Presenza di Griso / MINES - Presence of firedamp / MINES - Presence de méthane

<p>EPL Ma - Cat. M1</p> <p>Apparecchiature che devono rimanere alimentate in presenza di atmosfera esplosiva Device must continue to operate when an explosive atmosphere is present L'équipement doit continuer à fonctionner quand une atmosphère explosive est présente</p>	<p>EPL Mb - Cat. M2</p> <p>Apparecchiature cui deve potere essere interrotta l'alimentazione in presenza di atmosfera esplosiva Power supply to the device must be interrupted when explosive atmosphere is present L'alimentation du dispositif doit être interrompue quand une atmosphère explosive est présente</p>
--	--

4b. Zone di pericolo - GAS (G) / Dangerous zones - GASES (G) / Zones dangereuses - GAZ (G)

EPL	MODO DI PROTEZIONE PROTECTION TYPES MODE DE PROTECTION	PRINCIPIO* BASIC PRINCIPLE* PRINCIPE*	SIMBOLO SYMBOL SYMBOLE	NORMA STANDARD NORME
Ga Zona / Zone 0 Cat. 1G	SICUREZZA INTRINSECA - Apparecchiature a sicurezza intrinseca INTRINSIC SAFETY - Devices with Intrinsic Safety SECURITE INTRINSEQUE - Dispositifs avec sécurité intrinsèque	Prevenzione Prevention Prévention	Ex ia	EN 60079-11
	INCAPSULAMENTO - Apparecchiature incapsulate ENCAPSULATION - Encapsulated apparatus ENCAPSULAGE - Dispositifs encapsulés	Segregazione Segregation Isolation	Ex ma	EN 60079-18
Gb Zona / Zone 1 Cat. 2G	PROVA DI ESPLOSIONE - Custodie a tenuta di fiamma FLAME-PROOF - Flameproof enclosures ANTIDÉFLAGRANTE - Enveloppe antidéflagrante	Contenimento Containment Non-propagation	Ex d	EN 60079-1
	PRESSURIZZAZIONE - Apparecchiature pressurizzate PRESSURIZATION - Pressurized enclosures PRESSURISATION - Enveloppe à surpression	Segregazione Segregation Isolation	Ex px	EN 60079-2
	SICUREZZA AUMENTATA - Apparecchiature a sicurezza aumentata INCREASED SAFETY - Increased safety enclosures SECURITE AUGMENTEE - Protection par sécurité augmentée	Prevenzione Prevention Prévention	Ex e	EN 60079-7
	SICUREZZA INTRINSECA - Apparecchiature a sicurezza intrinseca INTRINSIC SAFETY - Intrinsic safety enclosures SECURITE INTRINSEQUE - Dispositifs avec sécurité intrinsèque	Prevenzione Prevention Prévention	Ex ib	EN 60079-11
	INCAPSULAMENTO - Apparecchiature incapsulate ENCAPSULATION - Encapsulated apparatus ENCAPSULAGE - Dispositifs encapsulés	Segregazione Segregation Isolation	Ex mb	EN 60079-18
Gc Zona / Zone 2 Cat. 3G	RIEMPIMENTO IN SABBIA - Apparecchiature a riempimento POWDER FILLING - Sand-Filled Enclosures REPLISSAGE PULVERULENT - Matériel protégé par remplissage pulvérulent	Segregazione Segregation Isolation	Ex q	EN 60079-5
	IMMERSIONE IN OLIO - Apparecchiature immerse in olio IMMERSION IN OIL - Oil immersion apparatus IMMERSION DANS L'HUILE - Matériel protégé par immersion dans l'huile	Segregazione Segregation Isolation	Ex o	EN 60079-6
	SICUREZZA INTRINSECA - Apparecchiature a sicurezza intrinseca INTRINSIC SAFETY - Intrinsic safety enclosures SECURITE INTRINSEQUE - Dispositifs avec sécurité intrinsèque	Prevenzione Prevention Prévention	Ex ic	EN 60079-11
	INCAPSULAMENTO - Apparecchiature incapsulate ENCAPSULATION - Encapsulated apparatus ENCAPSULAGE - Dispositifs encapsulés	Segregazione Segregation Isolation	Ex mc	EN 60079-18
	SEMPLIFICATO - Apparecchiature con modo di protezione "n" SIMPLIFIED - Enclosures with protection mode "n" NON INCENDIAIRE - Protection du matériel par mode de protection "n"	Tutti All Tous	Ex n	EN 60079-15

* Per PRINCIPIO si intende il principio sul quale si basa il tipo di protezione / PRINCIPE means the basic principle of the protection type
PRINCIPE désigne le principe sur lequel se base le mode de protection

EPL	MODO DI PROTEZIONE PROTECTION TYPES MODE DE PROTECTION	PRINCIPIO* BASIC PRINCIPLE* PRINCIPE*	SIMBOLO SYMBOL SYMBOLE	NORMA STANDARD NORME
Da Zona / Zone 20 Cat. 1D	SICUREZZA INTRINSECA - Apparecchiature a sicurezza intrinseca INTRINSIC SAFETY - Intrinsic safety enclosures SECURITE INTRINSEQUE - Dispositifs avec sécurité intrinsèque	Prevenzione Prevention Prévention	Ex iD	EN 60079-11
	INCAPSULAMENTO - Apparecchiature incapsulate ENCAPSULATION - Encapsulated apparatus ENCAPSULAGE - Dispositifs encapsulés	Segregazione Segregation Isolation	Ex mD	EN 60079-18
	PROTEZIONE MEDIANTE CUSTODIE - Apparecchiature protette mediante custodie PROTECTION BY ENCLOSURE - Devices protected by enclosure PROTECTION PAR ENVELOPPE - Protection par boîtier	Segregazione Segregation Isolation	Ex ta	EN 60079-31
Db Zona / Zone 21 Cat. 2D	PRESSURIZZAZIONE INTERNA - Apparecchiature pressurizzate PRESSURIZATION - Pressurized enclosures PRESSURISATION - Enveloppe à surpression	Segregazione Segregation Isolation	Ex pD	EN 60079-2
Dc Zona / Zone 22 Cat. 3D	PROTEZIONE MEDIANTE CUSTODIE - Apparecchiature protette mediante custodie PROTECTION BY ENCLOSURE - Devices protected by enclosure PROTECTION PAR ENVELOPPE - Protection par boîtier	Segregazione Segregation Isolation	Ex tb, tc	EN 60079-31

* Per PRINCIPIO si intende il principio sul quale si basa il tipo di protezione / PRINCIPLE means the basic principle of the protection type
PRINCIPE désigne le principe sur lequel se base le mode de protection

5. Classi di temperatura per i gas e le polveri

Temperature classification for gases and dusts

Classification des températures

Le diverse sostanze possono infiammarsi a temperature differenti, più bassa è la temperatura d'infiammabilità più la sostanza è pericolosa. La scelta di un'apparecchiatura antideflagrante in base alla temperatura di accensione delle sostanze è uno degli aspetti fondamentali per garantire la sicurezza degli impianti contro il rischio di esplosione. Il criterio di scelta è differente a seconda che l'apparecchiatura sia prevista per impiego in atmosfere potenzialmente esplosive per la presenza di gas oppure di polveri.

🇬🇧 Different substances may combust at different temperatures. The lower the combustion temperature is, the more dangerous the substance is. The temperature class is one of the parameters to consider choosing electrical equipment to be installed in places with danger of explosion. The selection criteria are different depending on whether the equipment is intended for gas or dust.

🇫🇷 Les diverses substances peuvent s'enflammer à des températures différentes. Plus la température d'inflammation est faible, plus la substance est dangereuse. En conséquence, la température d'inflammation est un des paramètres à prendre en compte dans le cas d'une installation dans une atmosphère explosive. Les critères de sélection sont différents s'il s'agit d'une atmosphère gazeuse ou poussiéreuse.

5a. Gas e vapori

Gas and vapors

Gaz et vapeurs

La temperatura superficiale delle apparecchiature elettriche non deve superare la temperatura di accensione delle sostanze pericolose presenti; per le apparecchiature elettriche del Gruppo II le massime temperature superficiali sono suddivise in classi di temperatura da T1 a T6 secondo i limiti indicati nella tabella:

🇬🇧 The surface temperature of the electrical equipment must not exceed the ignition temperature of the hazardous substances present; for group II electrical equipment the maximum surface temperatures are divided into temperature classes from T1 to T6 according to the limits indicated in the table below:

🇫🇷 Il appartient à l'utilisateur de vérifier que la température d'auto-inflammation de l'atmosphère est supérieure à la température maximale de surface des appareils (définie par sa classe). Autrement dit qu'une surface de ce matériel ne peut pas atteindre la température d'auto-inflammation de l'atmosphère explosive. Ci-dessous le tableau permettant de classer les niveaux de température :

CLASSE DI TEMPERATURA TEMPERATURE CLASS CLASSE DE TEMPERATURE	MASSIMA TEMPERATURA SUPERFICIALE DELL'APPARECCHIATURA MAXIMUM SURFACE TEMPERATURE OF THE EQUIPMENT TEMPERATURE DE SURFACE MAXIMALE DE L'EQUIPEMENT	TEMPERATURA DI ACCENSIONE DELLA SOSTANZA INFIAMMABILE IGNITION TEMPERATURE OF THE FLAMMABLE SUBSTANCE TEMPERATURE D'AUTO-INFLAMMATION DE LA SUBSTANCE INFLAMMABLE
T1	450°C	> 450°C
T2	300°C	> 300°C
T3	200°C	> 200°C
T4	135°C	> 135°C
T5	100°C	> 100°C
T6	85°C	> 85°C

Per le apparecchiature elettriche installate in atmosfere potenzialmente esplosive per la presenza di polveri è necessario prendere in considerazione la temperatura di accensione rispettivamente per la **nube di polvere** (T_{cl}) e per lo **strato di polvere** (T_{layer}).

Per evitare che le apparecchiature elettriche inneschino una nube di polvere con temperatura di innesco in °C (T_{cl}) è sufficiente in teoria che la temperatura superficiale massima T non superi T_{cl} . Di fatto la norma introduce un coefficiente di sicurezza e stabilisce una temperatura massima $T_{max\ cl} = (2/3) T_{cl}$.

Pertanto le apparecchiature devono avere una **temperatura superficiale massima**.

$$(T) \leq T_{max\ cl} = (2/3) T_{cl}$$

Se nel luogo considerato si possono formare strati di polvere, bisogna evitare che le apparecchiature elettriche possano accendere lo strato di polvere. Occorre quindi limitare la temperatura superficiale delle apparecchiature in relazione allo spessore dello strato di polvere.

Per ogni tipo di polvere è definita la temperatura minima di accensione per uno strato di 5 mm di spessore (T_{5mm}). La temperatura massima ($T_{max\ l}$) per evitare l'accensione degli strati di polvere deve essere inferiore di 75°C (margine di sicurezza) rispetto alla temperatura minima di accensione dello strato di 5 mm, ossia $T_{max\ l} = T_{5mm} - 75^\circ\text{C}$.

La temperatura superficiale dovrà essere minore o uguale al valore più basso tra $T_{max\ cl}$ e $T_{max\ l}$ e verrà indicata sulla targa del prodotto con il valore effettivo.

 The flash point of flammable dust must be taken into account when providing protection against flammable dust, where it is found in both **cloud form** (T_{cl}) and **in layers** (T_{layer}).

In order to prevent the electrical equipment from igniting a dust cloud with ignition temperature T_{cl} it is sufficient, in theory, that the maximum surface temperature (T) of the equipment does not exceed T_{cl} ; in practice, the standard introduces a safety coefficient and assumes a maximum temperature $T_{max\ cl} = (2/3) T_{cl}$.

Thus the equipment must have a **maximum surface temperature** (T) = $T_{max\ cl} = (2/3) T_{cl}$.

If dust layers may form in the area in question, it is necessary to prevent the electrical equipment from igniting the dust layer; for this purpose, the surface temperature of the equipment must be limited in relation to the thickness of the dust layer (generally indicated in the classification of the areas). For each type of dust, the minimum ignition temperature is defined for a layer with a thickness of 5 mm (T_{5mm}).

The maximum temperature ($T_{max\ l}$) to prevent the ignition of the dust layers must be 75°C (safety margin) less than the minimum ignition temperature of the 5 mm-thick layer.

Thus: $T_{max\ l} = T_{5mm} - 75^\circ\text{C}$.

The maximum surface temperature of the equipment must not exceed the lower value of the two temperatures $T_{max\ cl}$ and $T_{max\ l}$ and it will be indicated on the marking identification plate with the absolute value.

 La température d'auto-inflammation de la poussière doit être prise en compte pour les poussières inflammables où l'on trouve également des **nuages** et des **couches de poussière**.

Dans le cas de l'apparition d'un nuage de poussière, la **température maximale de surface** du matériel ne doit en aucun cas dépasser 2/3 de la température d'inflammation: Température max (C°) = 2/3 de la température d'inflammation d'un nuage de poussières (T_{cl}).

Dans le cas de formation de couches de poussières, la température doit être limitée en fonction de la présence d'une couche de poussière inférieure à 5 mm: Température max = 5 mm - 75 k (75 k étant le coefficient de sécurité égal à 75°C).

La température maximale de surface admissible doit toujours être inférieure au point d'auto-inflammation.



6. Targa identificativa delle apparecchiature antideflagranti:

Identification plate for explosion-proof devices:

Marquage des produits antidéflagrants :

Di seguito riportiamo un esempio di targa identificativa applicata sui dispositivi immessi sul mercato come previsto dalla normativa.

As required by the standard, here an example of the identification plate on each product put on the market with the following information.







Chaque produit présent sur le marché doit être marqué avec les informations ci-dessous.



Questa riporta:

This reports:

Cela montre :

-  Nome e logo del produttore
Name and logo of the manufacturer
Nom et logo du fabricant
-  Anno di fabbricazione
Year of manufacture
Année de fabrication
-  Numero di serie
The serial number
Numéro de série
-  Identificazione dell'apparecchiatura mediante codice prodotto
The equipment identification by defining the product code
Identification du dispositif par code produit
-  Numero di certificato
Number of certificate
N° du certificat
-  Avvertenze e marcatura Ex
Ex marking and warnings
Avertissements et marquage Ex

Per meglio comprendere la marcatura Ex, segue la descrizione dell'esempio mostrato nella pagina precedente, nelle singole sezioni che la compongono:

 To better understand the Ex marking, here the description of the different sections regarding the example on the previous page:

 Pour mieux comprendre le marquage Ex, ci-dessous une description des différents éléments par rapport à l'exemple vu dans la page précédente :

SEZIONI / SECTIONS	DESCRIZIONE / DESCRIPTION	SOMMARIO / SHORT SUMMARY / RÉSUMÉ COURT
	<p>Marchio distintivo comunitario specifico della protezione contro le esplosioni European distinctive community Mark for explosion-proof devices Marque distinctive communautaire pour produits antidéflagrants</p>	
II	<p>Gruppo di apparecchi Groups of equipment Catégorie d'appareils</p>	<p>I: miniere / mines II: Impianti di superficie (altre aree a rischio diverse da miniere) Equipment for Surface Installations (non-mining surface installations) Industries de surface vedi punto / see point / voir point 1</p>
2	<p>Categorie apparecchiature Equipment categories Catégorie d'équipement</p>	<p>1: utilizzabile nelle zone 0 o 20, 1 o 21, 2 o 22 for use in zones 0 or 20, 1 or 21, 2 or 22 utilisation en zones 0 ou 20, 1 ou 21, 2 ou 22 2: utilizzabile nelle zone 1 o 21, 2 o 22 for use in zones 1 or 21, 2 or 22 utilisation en zones 1 ou 21, 2 ou 22 3: utilizzabile nelle zone 2 o 22 for use in zones 2 or 22 utilisation en zones 2 ou 22</p>
GD	<p>Installabile sia in presenza di GAS sia POLVERI combustibili Suitable for explosive atmosphere due to GAS and flammable DUST Type d'atmosphère explosive par la présence de GAZ ou POUSSIÈRES</p>	<p>G=GAS / GAZ D=POLVERI / DUST / POUSSIÈRES vedi punto / see point / voir point 2</p>
Ex	<p>Identifica che è stato adottato un modo di protezione contro le esplosioni GAS (G) It identifies that a protection mode against explosions due to GAS (G) has been adopted Protection contre les explosions dans une atmosphère explosive GAZEUSE (G)</p>	<p>vedi punto / see point / voir point 4</p>
de	<p>Lettere identificanti il modo di protezione adottato per la presenza di atmosfera potenzialmente esplosiva con GAS (apparecchiatura che ha una parte protetta mediante custodia a prova di esplosione "d" ed una parte a sicurezza aumentata "e") Letters indicating the protection mode (against explosions due to GAS) adopted (Equipment with a part protected by an explosion-proof enclosure "d" and an increased safety part "e") Lettres qui indiquent le mode de protection adopté (contre une explosion due au GAZ) (exemple ici : produit avec enveloppe antidéflagrante + sécurité augmentée)</p>	<p>vedi punto / see point / voir point 4b</p>
IIC	<p>Gruppo di esplosione per la presenza di GAS (Gas tipico: Idrogeno e Acetilene, il gruppo IIC è il più pericoloso) Group of ignition due to GAS Representative ignition gas: Hydrogen and Acetylene, IIC Group is the highly dangerous group Groupe de GAZ (Gaz représentatif : Hydrogène et Acétylène, le groupe IIC est le plus dangereux)</p>	<p>IIA (Gas tipico: Propano) / (Representative gas: Propane) / (Gaz représentatif : Propane) IIB (Gas tipico: Etilene) / (Representative gas: Ethylene) / (Gaz représentatif : Ethylène) IIC (Gas tipico: Idrogeno e Acetilene) (Representative gas: Hydrogen and Acetylene) (Gaz représentatif : Hydrogène and Acétylène) vedi punto / see point / voir point 1</p>
T6	<p>Classe di temperatura assegnata in base alla massima temperatura superficiale delle apparecchiature per impiego in atmosfere potenzialmente esplosiva con GAS Temperature class, the maximum surface or absolute temperature, that the equipment can reach while operating in explosive atmosphere due to GAS Classe de température, température de surface maximum que l'équipement peut atteindre dans une atmosphère explosive GAZEUSE</p>	<p>T1, T2, T3, T4, T5, T6 vedi punto / see point / voir point 5a</p>



Gb	<p>Livello di protezione (EPL) offerto da un'apparecchiatura in atmosfere potenzialmente esplosiva con GAS</p> <p>Equipment Protection Level (EPL) in explosive atmosphere due to GAS</p> <p>Niveau de protection de l'équipement (EPL) en atmosphère explosive GAZEUSE</p>	<p>Ga, Gb, Gc vedi punto / see point / voir point 3</p>
Ex	<p>Identifica che è stato adottato un modo di protezione contro le esplosioni POLVERI (D)</p> <p>It identifies that a protection mode against explosions due to DUSTS (D) has been adopted</p> <p>Protection contre les explosions dans une atmosphère explosive POUSSIÈREUSE (D)</p>	<p>vedi punto / see point / voir point 4</p>
tb	<p>Lettere identificanti il modo di protezione adottato per la presenza di atmosfera potenzialmente esplosiva con POLVERI</p> <p>Apparecchiatura provvista di una custodia che impedisce l'ingresso della polvere e di mezzi per la limitazione delle temperature superficiali</p> <p>Letters indicating the protection mode (against explosions due to DUSTS) adopted</p> <p>Equipment protected by enclosure that prevents dust ingress and with devices that limit surface temperature</p> <p>Lettres qui indiquent le mode de protection adopté (contre une explosion due aux POUSSIÈRES)</p> <p>Équipement protégé par une enveloppe empêchant la pénétration des poussières et limitant la température de surface</p>	<p>vedi punto / see point / voir point 4c</p>
IIIC	<p>Gruppo di esplosione per la presenza di POLVERI</p> <p>Group of ignition due to DUSTS</p> <p>Groupe de POUSSIÈRES</p>	<p>IIIA (Particelle combustibili) / (Flammable Particles) (Substances inflammables)</p> <p>IIIB (Polveri non conduttive) / (Non-conductive dusts) (Poussières non-conductrices)</p> <p>IIIC (Polveri conduttive) / (Conductive dusts) (Poussières conductrices)</p> <p>vedi punto / see point / voir point 1</p>
T85°C	<p>Temperatura superficiale indicata sulla targa del prodotto con il valore effettivo (dovrà essere minore o uguale al valore più basso tra $T_{max\ cl}$ e $T_{max\ l}$)</p> <p>Surface temperature indicated on the marking identification plate with the absolute value (it must not exceed the lower value of the two temperatures $T_{max\ cl}$ and $T_{max\ l}$)</p> <p>Température de surface maximum que l'équipement peut atteindre. (Ne doit pas dépasser une valeur comprise entre T_{max} et $T_{max\ l}$)</p>	<p>T.. °C vedi punto / see point / voir point 5b</p>
Db	<p>Livello di protezione (EPL) offerto da un'apparecchiatura in atmosfere potenzialmente esplosiva con POLVERI</p> <p>Equipment Protection Level (EPL) in explosive atmosphere due to DUSTS</p> <p>Niveau de protection de l'équipement (EPL) dans une atmosphère explosive POUSSIÈREUSE</p>	<p>Da, Db, Dc vedi punto / see point / voir point 3</p>
IP66	<p>Grado di protezione IP IP rating Indice de protection IP</p>	<p>vedi tabella a pagina / see table at page / voir page 5</p>
CE	<p>Simbolo grafico "Conformité Européenne"</p> <p>Indica che il prodotto è conforme ai requisiti essenziali previsti da Direttive in materia di sicurezza, sanità pubblica, tutela del consumatore ecc.</p> <p>Graphic Symbol "Conformité Européenne". It indicates that the product conforms with Directive specifications relating to material, public health, consumer safety etc.</p> <p>Symbole graphique "Conformité Européenne". Indique que le produit est conforme aux directives européennes relatives au matériel, la santé publique et la sécurité du consommateur etc.</p>	
0477	<p>Numero dell'organismo notificato preposto alla sorveglianza della produzione in accordo alla Direttiva ATEX</p> <p>N° of the notified body responsible for supervision of production according to ATEX Directive</p> <p>N° de l'organisme notifié intervenu dans la procédure de contrôle de la fabrication selon la Directive ATEX</p>	
CESI 05 ATEX 043	<p>Numero attestato di esame "CE del tipo" composto dall'identificativo dell'ente che ha emesso il certificato, anno, Direttiva ATEX e numero dell'attestato</p> <p>"EC type" Examination Certificate No.: identification entity who issued the certificate, the year of issue and the number of the certificate</p> <p>N° de l'organisme notifié pour la délivrance d'un certificat "CE de type" avec l'année d'émission, la Directive ATEX et le n° du certificat</p>	



ESCAPE

Evacuazione a 360 gradi
360 degree Evacuation
Evacuation à 360 degrés



SIRENA



INDICE / INDEX / INDEX

244 Introduzione / Introduction / Introduction

246 Sistemi industriali / Industrial systems / Systèmes industriels

248 Scelta dei prodotti / Product selection / Choix des produits

250 Sistema tradizionale - Sistema PCS
Traditional system - PCS system
Système traditionnel - Système PCS

252 Linea prodotti / Product range / Familles produits

252 F3 SEV

254 SEL 1SEV

256 SEO 1SEV

258 SEO 2SEV

260 STR 1SEV

262 PULSANTI / PUSH BUTTONS / BOUTONS

263 COMANDI BCP PCS / BCP PCS CONTROL BOX / BOITIER DE COMMANDE BCP PCS

264 CENTRALE PCS / PCS CENTRAL UNIT / CENTRALE PCS

265 ACCESSORI PCS - SUONI DISPONIBILI

PCS ACCESSORIES - AVAILABLE SOUNDS / ACCESSOIRES PCS - SONS DISPONIBLES



266 Gamma FA / FA range / Gamme FA

268 UN CONCEPT... INFINITE SOLUZIONI
ONE CONCEPT... ENDLESS SOLUTIONS / UN CONCEPT... DES SOLUTIONS INFINIES

270 SIR-E FA

271 SIR-E LED FA

272 SLR FA

273 XLF FA

274 BASI / BASES / BASES



276 Gamma ATEX / ATEX range / Gamme ATEX

278 BOX SEO ETH 20 MD/4U

279 EX 070 FLR - SLR S



280 Luci ausiliarie / Auxiliary beacons / Feux auxiliaires

281 Luci FA / FA beacons / Feux FA

282 Riferimenti Legislativi e Normative

283 Criteri di applicazione

284 Criteri di scelta dispositivi linea **ESCAPE**
ESCAPE range selection criteria
Choix des dispositifs ligne **ESCAPE**

287 Vademecum / Vademecum / Remarques

289 Sistemi per grandi aree / Large area evacuation systems / Systèmes d'alerte longue portée

INTRODUZIONE

Il panico è un particolare stato d'animo che spesso l'uomo assume quando si sente in pericolo: fa perdere la capacità di ragionare; fa compiere atti di isterismo e azioni anormali; fa prevalere l'istinto a fuggire, ad autodifendersi e alla prevaricazione fisica sugli altri.

Il panico è, dunque, molto pericoloso soprattutto in luoghi affollati e può provocare un numero di vittime maggiore rispetto a quelle generate dall'emergenza stessa.

Il **Decreto Legislativo 81/08 e s.m.i.**, tra le misure generali di tutela della salute e della sicurezza dei lavoratori nei luoghi di lavoro, individua anche "le misure di emergenza da attuare in caso di primo soccorso, di lotta antincendio, di evacuazione dei lavoratori e di pericolo grave e immediato". Sulla base delle prescrizioni sopra citate e sull'esito della valutazione del rischio d'incendio, il datore di lavoro adotta le necessarie misure organizzative e gestionali da attuare in caso di incendio, riportandole in un piano di emergenza elaborato in conformità ai criteri dell'allegato VIII del D.M. 10/03/98.

Il **Piano di Emergenza** è quindi uno strumento operativo mediante il quale vengono studiate e pianificate le operazioni da compiere per una corretta gestione degli incidenti. Il fine è quello di consentire un esodo ordinato e sicuro di tutti gli occupanti di un edificio, in caso di incendi, infortuni, fughe di gas, fuoriuscite di sostanze pericolose o qualsiasi altro evento calamitoso che determini la necessità di abbandonare una qualsiasi struttura (come nel caso di terremoti o inondazioni).

Uno degli strumenti più importanti che un piano di emergenza deve prevedere, è il **Piano di evacuazione** dell'area interessata (edificio, zona/capannone industriale, ufficio). È uno strumento operativo elaborato per consentire un abbandono ordinato, veloce e in tutta sicurezza dell'area a rischio, con un principale obiettivo: evitare il panico!

La gamma di **prodotti ESCAPE** nasce con lo scopo di fornire uno strumento qualificato ed indirizzato agli specialisti del settore (Responsabili del servizio sicurezza di Protezione e Prevenzione, Progettisti Specializzati, Protezione Civile, Uffici Tecnici Comunali) impegnati nella progettazione e realizzazione di Piani di Emergenza ed Evacuazione, in tutti i tipi di ambienti possibili: dall'abitazione ad uso civile, all'area esterna di grandi dimensioni interessata a possibili calamità.





INTRODUCTION

Panic is a particular state of mind that we often assume when we feel in danger: we lose the ability to reason; actions of hysteria and abnormal actions may occur; when we feel in danger, the instinct to run away prevails, as well as self-defense and physical prevarication on the others. Panic is, therefore, very dangerous especially in crowded places and it can cause a great number of victims in comparison to those produced by the same emergency.

The **Emergency Plan** is therefore an operational tool that allows studying and planning the required operations for a correct management of the accidents. The aim is allowing an orderly and safe emergency evacuation of all building occupants, in case of fires, accidents, gas leaks, emissions and losses of hazardous substances or in any adverse event (such as earthquakes or floods).

One of the most important tools that an emergency plan should foresee is the **Evacuation Plan** of the concerned area (building, industrial shed, office), an operational tool that allows a fast and controlled exodus, avoiding panic!

ESCAPE range has been engineered to provide a qualified tool addressed to specialists (Prevention and Protection Service Managers, Project Specialists, Civil Protection, Municipal engineering departments) involved in the design and development of Emergency and Evacuation Plans of civil habitation buildings, large areas affected by calamities.



INTRODUCTION

La panique s'installe souvent quand l'homme se sent en danger : elle fait perdre la capacité de raisonner ; elle déclenche des comportements hystériques et des actions anormales ; elle fait prévaloir l'instinct de fuite, d'autodéfense et la malversation physique d'autrui. La panique est donc particulièrement dangereuse dans les lieux bondés et peut provoquer un nombre de victime important.

Le **Plan d'Urgence** est un outil opérationnel décrivant les actions à suivre pour une gestion correcte des accidents. L'objectif est d'évacuer de façon ordonnée et sécurisée les occupants d'une zone en cas d'incendie, d'accident, de fuite de gaz, de déversement de substances dangereuses ou n'importe quel autre événement calamiteux obligeant l'abandon de la structure touchée (comme en cas de tremblements de terre et d'inondations).

L'un des éléments les plus importants que le plan d'urgence doit prévoir est le **Plan d'Evacuation** de la zone accidentée (bâtiments, usines, bureaux...). C'est un outil opérationnel dont l'objectif est l'abandon ordonné, rapide et en toute sécurité de la zone de risque afin d'éviter la panique.

La gamme de produit **ESCAPE** offre aux spécialistes du secteur les outils adaptés (Responsable Du Service de Sécurité et Prévention, Projeteur Spécialisé, Protection Civile, Bureaux techniques) pour l'élaboration des plans d'urgence et d'évacuation pour tout type d'environnement : des habitations civiles aux grandes zones extérieures sensibles aux accidents.



SISTEMI INDUSTRIALI

Nell'ambito delle misure di PREVENZIONE e PROTEZIONE, la segnalazione acustica è un elemento fondamentale del sistema perché dà l'avvio alle fasi del piano di evacuazione e alle procedure di intervento, consentendo l'attuazione delle misure previste per la sicurezza dei lavoratori e delle persone presenti.

Per scegliere una corretta filosofia e configurazione degli elementi utili a creare un idoneo impianto di segnalazione acustica di allarme ed evacuazione, è necessario considerare alcuni aspetti:

- conoscere le reali condizioni ambientali d'impiego valutando fattori come la rumorosità di fondo, l'area che deve essere coperta, la presenza di ostacoli (muri, scaffali, pareti fono assorbenti)
- considerare le variabili del segnale acustico sorgente, soprattutto in termini di intensità sonora e di frequenza.

Quest'ultimo punto è fondamentale per determinare nel concreto il tipo di dispositivi in grado di garantire un livello acustico adeguato (nettamente superiore al rumore ambientale), facilmente riconoscibile e nettamente distinguibile. Individuato il corretto dispositivo diventa importante valutarne la quantità e la tipologia; Sirena propone con la linea **ESCAPE** quattro modelli di sirena e un segnalatore luminoso, basati su due diverse filosofie di funzionamento:

SISTEMA TRADIZIONALE

F3 SEV/4S-AA
SEL 1SEV/4S-AA
SEO 1SEV/4S-AA
SEO 2SEV/4S-AA
STR 1SEV/4S-AA

SISTEMA PCS

F3 SEV/4S-AA PCS
SEL 1SEV/4S-AA PCS
SEO 1SEV/4S-AA PCS
SEO 2SEV/4S-AA PCS
STR 1SEV/4S-AA PCS

I due sistemi si riferiscono al modo di attivazione e controllo con il quale è possibile gestire l'impianto. Nello specifico degli impianti con "Protocollo di comunicazione seriale" (PCS), Sirena ha perseguito una filosofia volta alla massima semplificazione nell'esecuzione, unitamente ad un controllo totale e costante su ogni componente inserito nel sistema. Nella soluzione d'impianto seriale tutti gli elementi del sistema sono connessi tra loro con un unico cavo schermato a due fili che li mette in comunicazione con la centrale, consentendo una notevole semplificazione della cablaggio dell'impianto unita ad una notevole riduzione dei costi.

SISTEMA TRADIZIONALE
TRADITIONAL SYSTEM / SYSTEME TRADITIONNEL





INDUSTRIAL SYSTEMS

As part of the measures of PREVENTION and PROTECTION, the acoustic signal is a key element of the system because from the start to the phases of evacuation plan and procedures for intervention, it allows the implementation of the measures for the safety of workers and people present.

In order to choose a correct philosophy and elements configuration needed to create a suitable plant of audible alarm and evacuation, you should consider few things:

- to know the real environmental conditions of use considering factors such as ambient background sound, the area to be covered, the presence of obstacles (walls, shelves, sound absorbing walls)
- to consider the variables of the acoustic signal source, particularly in terms of sound intensity and frequency.

This last point is essential to determine in practice the type of devices that can guarantee an appropriate sound level (well above the ambient background noise), easily recognizable and clearly distinguishable. Identified the correct device, it becomes important to evaluate the numbers and type; Sirena offers with **ESCAPE** range, four models of siren based on two different philosophies of operation:

TRADITIONAL SYSTEM

F3 SEV/4S-AA
 SEL 1SEV/4S-AA
 SEO 1SEV/4S-AA
 SEO 2SEV/4S-AA
 STR 1SEV/4S-AA

PCS SYSTEM

F3 SEV/4S-AA PCS
 SEL 1SEV/4S-AA PCS
 SEO 1SEV/4S-AA PCS
 SEO 2SEV/4S-AA PCS
 STR 1SEV/4S-AA PCS

The two systems differ in the activation and control mode. More specifically, for PCS "Serial Communication" systems, Sirena has pursued a philosophy to simplify implementation as well as constant and total control of each system component. All PCS System components are connected together and to the central unit, through a two-wire shielded cable, simplifying system wiring, thus allowing considerable cost reduction.



SYSTEMES INDUSTRIELS

Parmi les mesures de PREVENTION et de PROTECTION, la signalisation acoustique est un élément fondamental du système car elle donne le départ du plan d'évacuation et permet la mise en œuvre des mesures prévues pour garantir la sécurité des travailleurs et des personnes présentes.

Afin de choisir la philosophie et la configuration correcte pour un système d'évacuation le plus adapté, il est utile de prendre en compte certains éléments :

- connaître l'environnement d'application : le niveau sonore ambiant, l'aire qui doit être couverte, la présence d'obstacles (murs, étagères, murs acoustiques absorbants)
- considérer les variables du signal source en termes d'intensité sonore et de fréquence.

Ce dernier point est fondamental pour définir le type de dispositif capable de garantir un niveau sonore adéquate (nettement supérieur au bruit ambiant), facilement reconnaissable et distinguable.

Identifier la correcte installation revient à définir le type et le nombre de dispositifs composant le système ; avec sa gamme **ESCAPE**, Sirena propose 4 modèles de sirènes et un feu développés sur deux types de fonctionnement :

SYSTEME TRADITIONNEL

F3 SEV/4S-AA
 SEL 1SEV/4S-AA
 SEO 1SEV/4S-AA
 SEO 2SEV/4S-AA
 STR 1SEV/4S-AA

SYSTEME PCS

F3 SEV/4S-AA PCS
 SEL 1SEV/4S-AA PCS
 SEO 1SEV/4S-AA PCS
 SEO 2SEV/4S-AA PCS
 STR 1SEV/4S-AA PCS

Les deux systèmes se différencient par leur mode d'activation et le mode de contrôle qui permet de gérer l'installation. Les installations « Protocole de communication en série » (PCS) ont été développées pour être simple à utiliser et pour permettre le contrôle total et permanent de chaque composant du système. La communication des éléments de l'installation entre eux et avec la centrale est assurée par un câble blindé à deux fils, cette particularité simplifie grandement le câblage de l'installation et en réduit également les coûts.

SISTEMA PCS
 PCS SYSTEM / SYSTEME PCS



SCelta DEI PRODOTTI

Il **SISTEMA TRADIZIONALE** e il **SISTEMA PCS** comprendono prodotti con identiche caratteristiche di funzionalità, ma con diverse caratteristiche di prestazione in termini di intensità acustica: questo per permettere un corretto adattamento tra prodotto ed ambiente di lavoro. È possibile, tramite dip-switch, selezionare all'interno dei dispositivi quattro suoni tra gli otto esistenti ed abbinarli alle priorità definite.

Per ambienti civili (uffici, sale riunioni, locali aperti al pubblico, scuole, palestre, ospedali) è consigliata l'installazione dei modelli SEL 1SEV/4S-AA o F3 SEV/4S-AA che per le loro caratteristiche si inseriscono armoniosamente nell'ambiente e permettono, grazie alla progressività ed alla regolazione dell'intensità acustica, di garantire la sicurezza senza creare panico.

Ad esempio, in ambiente ufficio open-space con dimensione 200-300 mq circa è sufficiente installare un dispositivo SEL 1SEV/4S-AA o F3 SEV/4S-AA.

Gli ambienti industriali, normalmente rumorosi e strutturati su architetture variabili di caso in caso, sono soggetti a valutazioni attente legate al tipo di produzione; si tratta inoltre di ambienti con intenso afflusso di persone: nel 95% dei casi le caratteristiche del rumore ambientale in essi presenti impone l'uso di sistemi per la gestione dell'emergenza in grado di produrre suoni e non messaggi vocali.

Su una superficie di 1000 mq, con una rumorosità di fondo di 70/75 dB potrà essere sufficiente l'installazione di un dispositivo modello SEO 1SEV/4S-AA.

Su un'area di 2000/2500 mq, sempre con una rumorosità ambientale di 75/80 dB, occorrerà installare almeno un dispositivo modello SEO 2SEV/4S-AA.

Nella situazione ambientale precedentemente descritta, con una rumorosità superiore a 80 dB dovuta alla presenza di macchinari e/o altre fonti di rumore, sarà necessario invece prevedere l'impiego di almeno 3 o 4 dispositivi SEO 2SEV/4S-AA o SEO 1SEV/4S-AA.

Occorre sempre garantire una corretta distribuzione del suono in modo che il segnale acustico sia udibile, senza essere eccessivo o doloroso come indicato dalle principali normative a livello mondiale. Per un impianto ottimale è inoltre consigliabile l'installazione di dispositivi luminosi in abbinamento alle sirene SEV.





PRODUCT SELECTION

The **TRADITIONAL SYSTEM** and the **PCS SYSTEM** include products with identical functionality features but different performance characteristics in terms of acoustic output level: this allows a perfect adaptation to the work environment. It is possible to select, via dip-switch, four of the eight existing sounds, matching them with the set out priorities.

For civil applications (offices, meeting rooms, public premises, schools, gyms, hospitals) we suggest the installation of types SEL 1SEV/4S-AA or F3 SEV/4S-AA. Their features harmoniously blend with these environments; thanks to the progressive nature and regulation of sound output, they ensure safety without inducing panic.

E.g., in an open-space office with a surface of 200-300 sqm the installation of a device SEL 1SEV/4S-AA or F3 SEV/4S-AA is sufficient.

Industrial applications, usually noisy environments, are subject to careful evaluations depending on the type of production. Due to the massive influx of people and the presence of a high environmental noise, these places impose the use of systems able to manage the emergency producing sounds and not vocal messages.

On a surface of 1000 sqm, with an ambient background noise of 70/75 dB the installation of a device SEO 1SEV/4S-AA may be sufficient.

On an area of 2000/2500 sqm, with an ambient background noise of 75/80 dB, at least a SEO 2SEV/4S-AA should be installed.

In the same place but with a background noise level higher than 80 dB, due to the presence of machinery and/or other noise sources, it will be necessary to install at least 3 or 4 devices SEO 2SEV/4S-AA or SEO 1SEV/4S-AA.

A correct sound distribution must be guaranteed, so that the acoustic signal should provide an audible warning without being too loud or causing panic and discomfort, according to international norms. For optimum system efficiency, visual signals shall be added to SEV warning sirens.



CHOIX DES PRODUITS

Les dispositifs compris dans le **SYSTEME TRADITIONNEL** et le **SYSTEME PCS** proposent les mêmes caractéristiques de fonctionnement, ils proposent cependant des caractéristiques différentes en termes d'intensité acoustique : cette différence permet de correctement adapter l'installation à l'environnement de travail. Il est possible de programmer 4 sons parmi les 8 disponibles, la sélection se fait par des micros interrupteurs à l'intérieur des dispositifs.

Pour les environnements civils (bureaux, salles de réunion, locaux ouverts au public, écoles, salles de sport, hôpitaux) nous recommandons l'installation des modèles SEL 1SEV/4S-AA ou F3 SEV/4S-AA, qui pour leurs caractéristiques sont adaptées à ce type d'application. La puissance réglable et la progressivité du volume garantissent la sécurité sans créer la panique.

Par exemple, pour des bureaux « open-space » d'environ 200 à 300m² il est suffisant d'installer un dispositif SEL 1SEV/4S-AA ou F3 SEV/4S-AA.

Pour les environnements industriels, souvent bruyants et bâtis avec des architectures variées, une évaluation particulière doit être réalisée en fonction du type d'activité ; il s'agit aussi d'espace fortement fréquenté par des personnes : dans 95% des cas le niveau sonore ambiant impose l'utilisation d'un dispositif diffusant des sons et non des messages enregistrés.

Pour une superficie de 1000m², avec un bruit ambiant de 70/75 dB il est suffisant d'installer un dispositif SEO 1SEV/4S-AA.

Pour une surface de 2000/2500m², avec un bruit ambiant de 75/80 dB, il est nécessaire d'installer au moins un dispositif SEO 2SEV/4S-AA.

Pour la même surface que précédemment avec un bruit ambiant supérieur à 80 dB dû à la présence de machines ou autre, il s'impose d'installer 3 ou 4 dispositifs SEO 2SEV/4S-AA ou SEO 1SEV/4S-AA.

L'impératif est de garantir un volume sonore toujours audible, sans être excessif et nuisible comme indiqué dans les premières normes mondiales. Pour une installation optimale, nous recommandons l'installation complémentaire de signalisation visuelle.



SISTEMA TRADIZIONALE

TRADITIONAL SYSTEM / SYSTEME TRADITIONNEL

Il **SISTEMA CON COLLEGAMENTO TRADIZIONALE** offre prodotti che possono essere attivati mediante la semplice chiusura o apertura di un contatto (pulsante o relè). Sul pannello frontale del dispositivo sono presenti indicatori luminosi che ne segnalano la condizione, sia questa di perfetto funzionamento o di eventuale anomalia (problemi relativi alla batteria di back-up, o sull'integrità degli speaker).

Hanno caratteristiche acustiche e di funzionamento identiche in tutto e per tutto alle sirene della linea seriale che descriveremo in seguito e sono particolarmente adatte per la segnalazione in ambienti con dimensioni poco estese e di struttura semplice, in cui la segnalazione può essere gestita con comandi locali.

Le sirene Tradizionali diventano complesse da collegare e gestire, con un grosso dispendio in termini di cablaggio qualora si volessero adottare singole soluzioni in comparti diversi di una stessa realtà, per poter garantire un'evacuazione progressiva e/o generale dell'impianto.

Il sistema Tradizionale garantisce le caratteristiche acustiche previste dai decreti in vigore: è importante sottolineare che in ottica di manutenzione impianto, l'assenza di un controllo gestito da centrale implica indubbiamente costi maggiori.



The **TRADITIONAL CONNECTION SYSTEM** offers products that can be activated by just the closing or opening of a contact (button or relay). On the front panel of the device there are light indicators signaling the system's condition, both the perfect operation and a failure (problems with battery back-up or speakers' integrity).

They have identical characteristic, acoustic and operation, to the sirens of the serial range that will be described later, and are particularly suitable for signaling in environments with dimensions not so extended or with simple structure, where the message can be managed with local controls.

Traditional sirens become complex to connect and manage, with a great expenditure in terms of wiring if you want to adopt individual solutions in different compartments of the same reality, in order to ensure a progressive and/or general evacuation system.

The Traditional system complies with acoustic requirements as set out in the decrees in force: it is important to emphasize that in the system maintenance, the absence of a control operated by the central implies undoubtedly higher costs.



Le **SYSTEME AVEC CÂBLAGE TRADITIONNEL** propose des dispositifs qui peuvent être activés par la simple ouverture ou fermeture d'un contact électrique (bouton ou relais). Sur la face avant du produit sont installés des indicateurs lumineux signalant l'état de fonctionnement du système, ils indiquent un fonctionnement normal ou d'éventuelles anomalies (problème sur la batterie de secours ou sur les sirènes).

Les sirènes composant les deux types de systèmes ont des caractéristiques acoustiques et de fonctionnement strictement identique. Elles sont particulièrement adaptées pour des petites surfaces de structure simple dans lesquels le signal d'alerte peut être commandé localement.

Le système traditionnel devient difficile à mettre en place et à gérer, avec des dépenses de câblage importante, lorsqu'on décide d'adopter une solution unique dans chaque parties de la même usine.

SISTEMA PCS

PCS SYSTEM / SYSTEME PCS

Il **SISTEMA DI COMUNICAZIONE SERIALE PCS** offre una grande flessibilità in caso di implementazione o modifica e la possibilità di attivare allarmi sia in modo localizzato che generale. Le esigenze delle singole realtà verranno esaminate e sviluppate dal nostro servizio programmazione PCS insieme al cliente.

La sua caratteristica saliente è quella di avere un monitoraggio costante di ogni elemento installato (sirene, luci, interruttori di emergenza), nonché dell'efficienza della linea stessa. Ogni eventuale anomalia che si riferisce a tali dispositivi e alle loro funzioni, tra le quali sono primarie l'efficienza della batteria, la funzionalità delle unità acustiche magnetodinamiche delle sirene e la presenza della rete di alimentazione, è subito individuata e segnalata in centrale con un avviso acustico ed un report visibile su display in tempo reale e memorizzato in centrale (la centrale ha la capacità di registrare e mantenere in memoria fino a 1.000 eventi).

Il sistema di controllo attuato consente un ulteriore vantaggio economico nella manutenzione grazie all'immediata individuazione del punto critico.

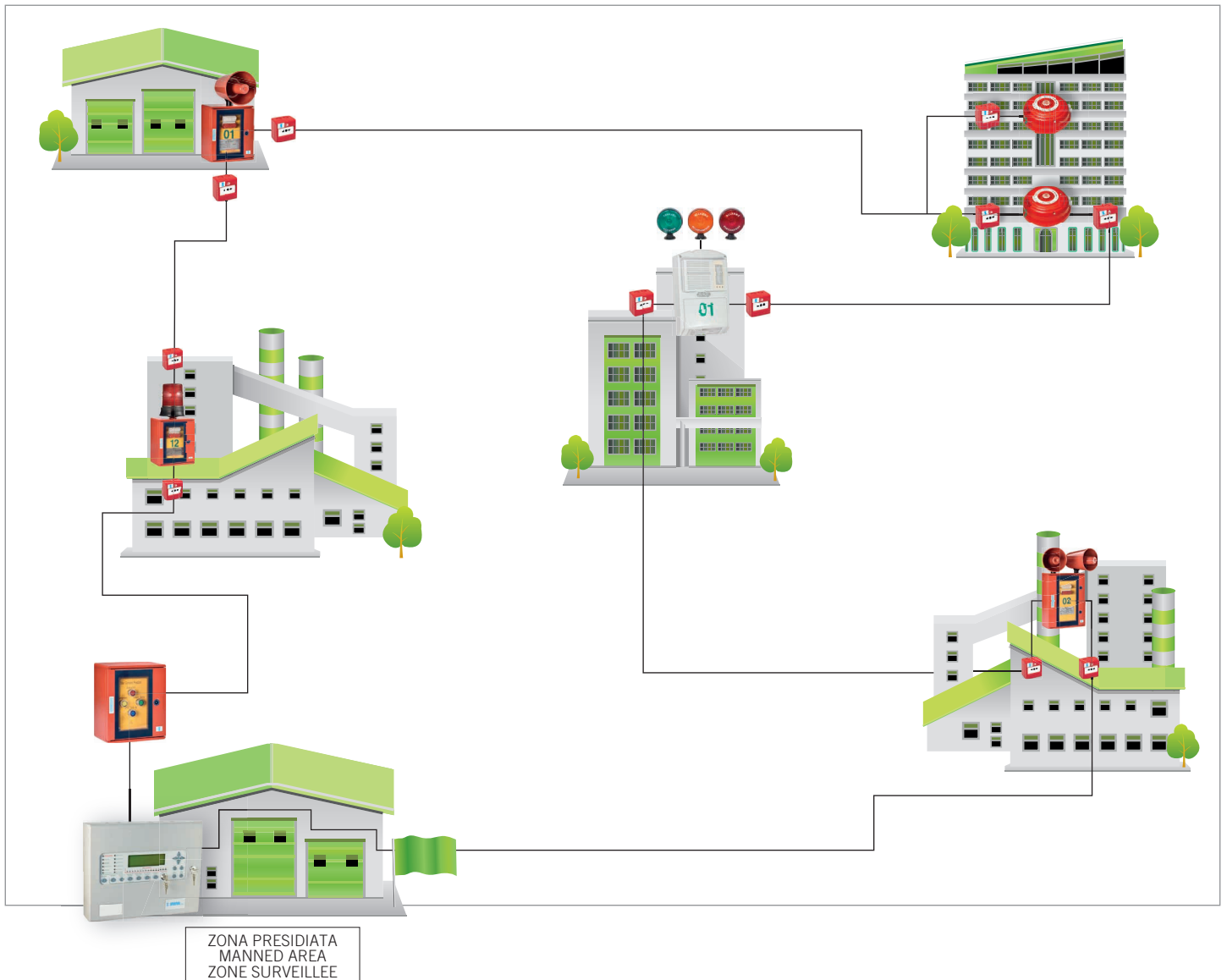

The **SERIAL COMMUNICATION PCS SYSTEM** offers great flexibility in case of implementation or modification and provides the possibility to activate alarms in both localized and general mode. Each individual company requirement will be examined and developed by our PCS Programming Service, together with the customer.

Distinctive feature of this philosophy is to have a constant monitoring of each installed element (sirens, lights, emergency switches), as well as the efficiency of the line in itself. Any anomalies referring to these devices and their functions, among which are primary battery efficiency, the functionality of the magneto-dynamic acoustic units and the supply network is immediately detected and reported in the Central with an audible alert and a report on the visible display in real time and stored in the central (the Central has the ability to record and keep in memory up to 1.000 events).

The control system allows a further economic advantage in the maintenance thanks to the immediate identification of the critical point.



Le **SYSTEME D'INSTALLATION EN SERIE PCS** offre une grande flexibilité en cas d'élargissement ou modification du système, et la possibilité d'activer les alarmes de manière générale et localisée.

Il offre l'avantage d'un retour constant sur l'état de fonctionnement de chaque élément installé (sirènes, feux, interrupteurs d'urgence), ainsi que sur la ligne même. Toute éventuelle anomalie concernant les dispositifs et leurs fonctions, parmi lesquelles l'efficacité de la batterie, le fonctionnement des unités magnétodynamiques des sirènes et la présence secteur, est immédiatement identifiée et signalée à la centrale par un signal acoustique et un rapport imprimé en temps réel et mémorisé en central (la centrale peut enregistrer et mémoriser un maximum de 1.000 événements).

Le système de contrôle permet une identification rapide du défaut critique et facilite donc grandement la maintenance du système.

F3 SEV



F3 SEV/4S-AA
F3 SEV/4S-AA PCS

Corpo / Body / Corps



CODICE A DUE CIFRE

Caratteri (di grandi dimensioni), identificativi del dispositivo nell'ambito dell'impianto, di colore verde autorifrangente (disponibile su richiesta)

TWO-DIGIT CODE

Device identification code in large green self-refracting characters (on request)

CODE A DEUX CHIFFRES

Identifiant du dispositif en fonction de l'installation, grandes dimensions, couleur verte (disponible sur demande)

TARGHETTA ADESIVA CON:

- CPR
- numero di serie
- dati tecnici
- data di produzione

ADHESIVE LABEL WITH:

- CPR no.
- serial no.
- technical data
- date of production

AUTOCOLLANT AVEC :

- CPR
- numéro de série
- données techniques
- date de fabrication



* Con segnali luminosi ausiliari attivi / With active luminous signals / Avec signal lumineux auxiliaire

F3 SEV

V AC	230
mA	50
dB(A)1m	max 108*

* Il valore del livello sonoro previsto dalla EN 54-3 è disponibile su richiesta
Acoustic output value according to EN 54-3 available on request
La valeur du niveau sonore prévu par la norme EN 54-3 est disponible sur demande

Codici / Codes

F3 SEV/4S-AA / PCS

F3 SEV/4S-AA	55307	55308
F3 SEV/4S-AA PCS	55337	55338

Sirena evacuazione ad alta potenza per zone residenziali, F3 SEV/4S-AA è disponibile per sistema tradizionale e per sistema PCS F3 SEV/4S-AA PCS.

Tensione operativa

230V AC +/-10%

Struttura apparecchio

- VANO FRONTALE con feritoie per fuoriuscita suono e luce di segnalazione a LED
- AUTOTEST DI CONTROLLO OGNI 24 H relativo all'assenza di tensione di rete, al livello di tensione batteria, all'impedenza dell'altoparlante. Tre led di controllo, posizionati sotto il frontalino luminoso, indicano le eventuali anomalie
 - SISTEMA TRADIZIONALE - Un relè con contatto C-NC-NA (normalmente aperto) consente di remotare il segnale di anomalia
 - SISTEMA PCS - Le segnalazioni di anomalia sono riportate sul display della CENTRALE PCS

Funzione

4 livelli di allarme (allertamento, evacuazione, cessato allarme, incendio). Quest'ultimo è attivabile tramite inversione di polarità dalla Centrale Antincendio, secondo la norma UNI EN 54-3.

LIVELLO 1 | ALLERTAMENTO

LIVELLO 2 | EVACUAZIONE

LIVELLO 3 | CESSATO ALLARME

LIVELLO 4 | INCENDIO

IMPORTANTE: possibilità di collegare un unico segnalatore luminoso (luce ausiliaria a flash), attivato dai singoli suoni di allarme.

La sirena dispone complessivamente di 8 suoni. Ha un abbinamento ai 4 livelli impostato di default, personalizzabile mediante dip-switch.

Frontalino luminoso trasparente a led

Due colori per le funzioni di controllo:

LED VERDE LAMPEGGIANTE = STATO ATTIVO presenza rete e funzionamento efficiente del dispositivo. Il colore verde è disattivato durante qualsiasi allarme

LED ROSSO LAMPEGGIANTE = ALLARME IN CORSO

Progressività del suono

Questa funzione consente di evitare uno shock a persone vicine all'apparecchio. L'intensità del suono incrementa in 10 sec. dal livello minimo (75 dB) al livello massimo (impostato mediante il POTENZIOMETRO di regolazione). La funzione è disattivabile tramite selettore dip-switch.

Opzioni di sistema

SISTEMA TRADIZIONALE: no RICEVITORE RADIO.

SISTEMA PCS: il dispositivo F3 SEV/4S-AA PCS dispone di un MODULO di COMUNICAZIONE I/O - 4 IN/4 OUT con doppio ISOLATORE DI LINEA. Il componente verrà indirizzato in fase di programmazione per la comunicazione seriale con la CENTRALE SEO SEV SY1 o SY2.

Certificazioni / Certifications



NUMERO CPR / CPR NUMBER / NUMERO CPR

4S-AA 1328-CPR-0477

4S-AA PCS 1328-CPR-0478

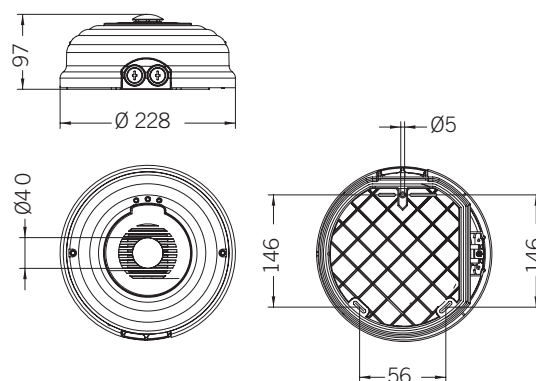

F3 SEV





High power evacuation warning siren for residential areas, **F3 SEV/4S-AA** is available for traditional system or for PCS system **F3 SEV/4S-AA PCS**.

Voltages

230V AC +/-10%

Device structure

- FRONT COVER with vents (allowing sound emission) and with LED light
- Self-diagnosis: an automatic control test is carried out every 24 hours relating to absence of mains power supply, low battery charge, interruption of the magneto-dynamic unit. Three LEDs positioned under the transparent light source indicate the possible anomalies.
 - TRADITIONAL SYSTEM - A relay with a C-NC-NO contact (normally open) allows remote localization of fault signal
 - SERIAL PCS SYSTEM - Any anomalies are reported on the visible display of the PCS CENTRAL UNIT

Function

4 levels of alarm (warning, evacuation, all clear, fire alarm).

The sound relating to the fire alarm is activated by means of polarity inversion by the Fire Alarm Control Box, according to UNI EN 54-3 Norm.

LEVEL 1 | WARNING
LEVEL 2 | EVACUATION
LEVEL 3 | ALL CLEAR
LEVEL 4 | FIRE ALARM

IMPORTANT: it is possible to connect one beacon only (auxiliary flashing beacon), activated by each single alarm sound.

A dip-switch allows four sound options to be selected from a total of eight to be combined to the priorities established.

Front cover with led light

Bi-color LED light for control functions:

GREEN FLASHING LIGHT = INDICATES THAT THE DEVICE IS ON, the presence of electricity and good operation.

The green light is deactivated during any alarm situation

RED FLASHING LIGHT = INDICATES AN ALARM SITUATION

Progressive sound

This function, starting from a min. sound output of 75 dB reaching the max. level set within 10 sec., avoids distress to the people in the area.

The device has a POTENTIOMETER to regulate the max. sound level required. This function is deactivated by means of the DIP-selector.

System options

TRADITIONAL SYSTEM: no RADIO RECEIVER

SERIAL PCS SYSTEM: **F3 SEV/4S-AA PCS** has a COMMUNICATION MODULE I/O - 4 IN/4 OUT - with double LINE ISOLATION.

The component will be addressed in the programming phase for serial communication with the CENTRAL UNIT SEV SY1 or SY2.



Sirène évacuation à haute puissance pour zones résidentielles, **F3 SEV/4S-AA** est disponible pour système traditionnel ou système PCS **F3 SEV/4S-AA PCS**.

Tension d'utilisation

230V AC +/-10%

Structure de l'appareil

- FACE AVANT : Ouvertures facilitant la propagation du son et présence d'une signalisation lumineuse
- Auto-contrôle toutes les 24h : l'alimentation de la ligne et le niveau de la batterie, la résistance des haut-parleurs. Trois LED de contrôle indiquant les éventuelles anomalies sont positionnées sous la barre lumineuse du panneau.
 - SYSTEME TRADITIONNEL - Un relais avec contacts (C-NC-NO), ouvert en fonctionnement normal, permet de remonter le signal d'anomalie.
 - SYSTEME PCS - Les signaux d'anomalie sont reportés sur l'écran de la CENTRALE PCS

Fonction

4 niveaux d'alerte (alerte, évacuation, fin d'alarme, incendie).

Ce dernier est activé par l'inversion de polarité par la centrale incendie, selon la norme UNI EN 54-3.

NIVEAU 1 | ALERTE
NIVEAU 2 | EVACUATION
NIVEAU 3 | FIN D'ALARME
NIVEAU 4 | INCENDIE

IMPORTANT : possibilité de connecter un seul dispositif lumineux (feu à éclat auxiliaire) sur un seul signal d'alarme.

La sirène dispose d'un total de 8 sons, 4 sons programmables, sélection des sons par micro-interrupteurs.

Face avant transparente et lumineuse à LED

Deux couleurs pour les fonctions de contrôle :

LED VERT CLIGNOTANT= STATUT ACTIF, présence du réseau d'alimentation et bon fonctionnement de l'appareil. La couleur verte est éteinte pendant l'alarme.

LED ROUGE CLIGNOTANT= ALARME EN COURS

Progressivité du son

Cette fonction permet d'éviter un choc aux personnes proches de l'unité.

L'intensité du son augmente en 10 secondes.

Du niveau minimum (75 dB) au niveau maximal (fixé par un POTENTIOMETRE de régulation). La fonction est désactivée par commutateur DIP.

Options du système

SYSTEME TRADITIONNEL : pas de réception radio

SYSTEME PCS : Le dispositif **F3 SEV/4S-AA PCS** a un MODULE DE COMMUNICATION I/O - 4 IN/4 OUT avec double ISOLATION DE LA LIGNE.

La programmation de la communication du dispositif avec la CENTRALE SEO SEV SY1 ou SY2 sera réalisée au préalable par nos soins.

SEL 1SEV



SEL 1SEV/4S-AA
SEL 1SEV/4S-AA PCS

CODICE A DUE CIFRE

Caratteri (di grandi dimensioni), identificativi del dispositivo nell'ambito dell'impianto, di colore verde autorifrangente (disponibile su richiesta)

TWO-DIGIT CODE

Device identification code in large green self-refracting characters (on request)

CODE A DEUX CHIFFRES

Identifiant du dispositif en fonction de l'installation, grandes dimensions, couleur verte (disponible sur demande)

TARGHETTA METALLICA CON:

- CPR
- numero di serie
- dati tecnici
- data di produzione

METAL PLATE WITH:

- CPR no.
- serial no.
- technical data
- date of production

PLAQUE METALLIQUE AVEC :

- CPR
- numéro de série
- données techniques
- date de fabrication



* Con segnali luminosi ausiliari attivi / With active luminous signals / Avec signal lumineux auxiliaire

SEL 1SEV

V AC	230
mA	50
dB(A)1m	max 114*

* Il valore del livello sonoro previsto dalla EN 54-3 è disponibile su richiesta
Acoustic output value according to EN 54-3 available on request
La valeur du niveau sonore prévu par la norme EN 54-3 est disponible sur demande

Codici / Codes**SEL 1SEV/4S-AA / PCS**

SEL 1SEV/4S-AA	55305
SEL 1SEV/4S-AA PCS	55335

Sirena evacuazione ad alta potenza per zone residenziali, **SEL 1SEV/4S-AA** è disponibile per sistema tradizionale e per sistema PCS **SEL 1SEV/4S-AA PCS**.

Tensione operativa

230V AC +/-10%

Struttura apparecchio

- VANO FRONTALE con feritoie per fuoriuscita suono e luce di segnalazione a LED
- AUTOTEST DI CONTROLLO OGNI 24 H relativo all'assenza di tensione di rete, al livello di tensione batteria, all'impedenza dell'altoparlante. 3 LED di controllo indicano le eventuali anomalie.
 - SISTEMA TRADIZIONALE - Un relè con contatto C-NC-NA (normalmente aperto) consente di remotare il segnale di anomalia
 - SISTEMA PCS - Le segnalazioni di anomalia sono riportate sul display della CENTRALE PCS

Funzione

4 livelli di allarme (allertamento, evacuazione, cessato allarme, incendio). Quest'ultimo è attivabile tramite inversione di polarità dalla Centrale Antincendio, secondo la norma UNI EN 54-3

IMPORTANTE: possibilità di abbinare quattro segnali luminosi ai quattro suoni:

LIVELLO 1 | ALLERTAMENTO | AMBRA

LIVELLO 2 | EVACUAZIONE | ROSSO

LIVELLO 3 | CESSATO ALLARME | VERDE

LIVELLO 4 | INCENDIO | PANNELLO OTTICO

La sirena dispone complessivamente di 8 suoni. Ha un abbinamento ai 4 livelli impostato di default, personalizzabile mediante dip-switch.

Barretta luminosa a led frontale

Tre colori per le funzioni di controllo:

LED VERDE LAMPEGGIANTE = STATO ATTIVO presenza rete e funzionamento efficiente del dispositivo. Il colore verde è disattivato durante qualsiasi allarme

LED ARANCIO LAMPEGGIANTE = GUASTO mancanza rete elettrica, livello batteria basso o altoparlante interrotto

LED ROSSO LAMPEGGIANTE = ALLARME IN CORSO

Progressività del suono

Questa funzione consente di evitare uno shock a persone vicine all'apparecchio. L'intensità del suono incrementa in 10 sec. dal livello minimo (75 dB) al livello massimo (impostato mediante il POTENZIOMETRO di regolazione). La funzione è disattivabile tramite selettore dip-switch.

Opzioni di sistema

SISTEMA TRADIZIONALE: il dispositivo **SEL 1SEV/4S-AA** dispone di un RICEVITORE RADIO del tipo supereterodina 433,92 Mhz - interfacciato con l'apparecchiatura elettronica per i test di prova (allertamento/evacuazione) mediante TELECOMANDO con codice di accesso programmabile ad esigenza dell'utente (n. 1.024 combinazioni), in dotazione con codice standard già memorizzato.

SISTEMA PCS: il dispositivo **SEL 1SEV/4S-AA PCS** dispone di un MODULO di COMUNICAZIONE I/O - 4 IN/4 OUT con doppio ISOLATORE DI LINEA. Il componente verrà indirizzato in fase di programmazione per la comunicazione seriale con la CENTRALE SEO SEV SY1 o SY2.

Certificazioni / Certifications

NUMERO CPR / CPR NUMBER / NUMERO CPR
4S-AA 1328-CPR-0471
4S-AA PCS 1328-CPR-0472

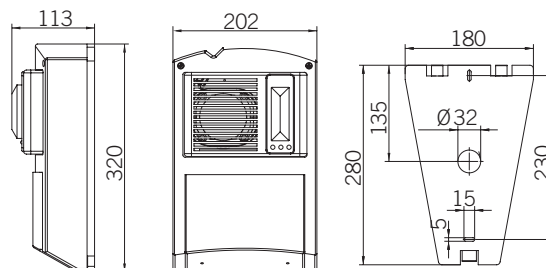
**SEL 1SEV****TELECOMANDO**

In dotazione nell'imballo per il sistema tradizionale

REMOTE CONTROL

Supplied with product (traditional system)

TELECOMMANDE

Fournie avec le système traditionnel



High power evacuation warning siren for residential areas, [SEL 1SEV/4S-AA](#) is available for traditional system or for PCS system [SEL 1SEV/4S-AA PCS](#).

Voltages

230V AC +/-10%

Device structure

- FRONT COVER with vents (allowing sound emission) and with LED light
- Self-diagnosis: an automatic control test is carried out every 24 hours relating to absence of mains power supply, low battery charge, interruption of the magneto-dynamic unit. 3 LEDs indicate the possible anomalies.
 - TRADITIONAL SYSTEM - A relay with a C-NC-NO contact (normally open) allows remote localization of fault signal
 - SERIAL PCS SYSTEM - Any anomalies are reported on the visible display of the PCS CENTRAL UNIT

Function

4 levels of alarm (warning, evacuation, all clear, fire alarm).

The sound relating to the fire alarm is activated by means of polarity inversion by the Fire Alarm Control Box, according to UNI EN 54-3 Norm.

IMPORTANT: it is possible to combine four luminous signals to four sounds:

LEVEL 1 | WARNING | AMBER
 LEVEL 2 | EVACUATION | RED
 LEVEL 3 | ALL CLEAR | GREEN
 LEVEL 4 | FIRE ALARM | LUMINOUS PANEL

A dip-switch allows four sound options to be selected from a total of eight to be combined to the priorities established.

Front led linear device

Three-color LED light for control functions:

GREEN FLASHING LED LIGHT = INDICATES THAT THE DEVICE IS ON, the presence of electricity and good operation. The green light is deactivated during any alarm situation
 AMBER FLASHING LED LIGHT = INDICATES A FAULT: no mains power supply, low battery level or loudspeaker interrupted
 RED FLASHING LIGHT = INDICATES AN ALARM SITUATION

Progressive sound

This function, starting from a min. sound output of 75 dB reaching the max. level set within 10 sec., avoids distress to the people in the area. The device has a POTENTIOMETER to regulate the max. sound level required. This function is deactivated by means of the DIP-selector.

System options

TRADITIONAL SYSTEM: [SEL 1SEV/4S-AA](#) has a Superheterodyne 433,92 Mhz RADIO RECEIVER - interfaced with the electronic equipment for testing purposes (warning/evacuation) by means of REMOTE CONTROL with a programmable access code as required by the user (1.024 combinations) supplied with a pre-registered standard code

SERIAL PCS SYSTEM: [SEL 1SEV/4S-AA PCS](#) has a COMMUNICATION MODULE I/O - 4 IN/4 OUT - with double LINE ISOLATION. The component will be addressed in the programming phase for serial communication with the CENTRAL UNIT SEV SY1 or SY2.



Sirène évacuation à haute puissance pour zones résidentielles, [SEL 1SEV/4S-AA](#) est disponible pour système traditionnel ou système PCS [SEL 1SEV/4S-AA PCS](#).

Tension d'utilisation

230V AC +/-10%

Structure de l'appareil

- FACE AVANT : Ouvertures facilitant la propagation du son et présence d'une signalisation lumineuse
- Auto-contrôle toutes les 24h : l'alimentation de la ligne et le niveau de la batterie, la résistance des haut-parleurs. Trois LED de contrôle indiquant les éventuelles anomalies.
 - SYSTEME TRADITIONNEL - Un relais avec contacts (C-NC-NO), ouvert en fonctionnement normal, permet de remonter le signal d'anomalie.
 - SYSTEME PCS - Les signaux d'anomalie sont reportés sur l'écran de la CENTRALE PCS

Fonction

4 niveaux d'alerte (alerte, évacuation, fin d'alarme, incendie).

Ce dernier est activé par l'inversion de polarité par la centrale incendie, selon la norme UNI EN 54-3.

IMPORTANT : possibilité de connecter quatre signaux lumineux aux quatre sons :

NIVEAU 1 | ALERTE | ORANGE
 NIVEAU 2 | EVACUATION | ROUGE
 NIVEAU 3 | FIN D'ALARME | VERT
 NIVEAU 4 | INCENDIE | TABLEAU VISUEL/OPTIQUE

La sirène dispose d'un total de 8 sons, 4 sons programmables, sélection des sons par micro-interrupteurs.

Barette frontale lumineuse à led

Trois couleurs pour les fonctions de contrôle :

LED VERT CLIGNOTANT= STATUT ACTIF, présence du réseau d'alimentation et bon fonctionnement de l'appareil. La couleur verte est éteinte pendant l'alarme.
 LED ORANGE CLIGNOTANT= DEFAILLANCE, absence de réseau, bas niveau de la batterie, haut-parleur interrompu.
 LED ROUGE CLIGNOTANT= ALARME EN COURS

Progressivité du son

Cette fonction permet d'éviter un choc aux personnes proches de l'unité.

L'intensité du son augmente en 10 secondes.

Du niveau minimum (75 dB) au niveau maximal (fixé par un POTENTIOMETRE de régulation). La fonction est désactivée par commutateur dip-switch.

Options du système

SYSTEME TRADITIONNEL : le dispositif [SEL 1SEV/4S-AA](#) a un RECEPTEUR ACOUSTIQUE « superhétérodyne de 433,92 Mhz » interfacé avec l'équipement électronique pour le test (alerte/évacuation) par TELECOMMANDE et code d'accès programmé au besoin de l'utilisateur (n. 1024 combinaisons), fourni avec code standard déjà mémorisé.

SYSTEME PCS : le dispositif [SEL 1SEV/4S-AA PCS](#) a un MODULE DE COMMUNICATION I/O - 4 IN/4 OUT avec double ISOLATION DE LA LIGNE.

La programmation de la communication du dispositif avec la CENTRALE SEO SEV SY1 ou SY2 sera réalisée au préalable par nos soins.

SEO 1SEV



SEO 1SEV/4S-AA
SEO 1SEV/4S-AA PCS

CODICE A DUE CIFRE

Caratteri (di grandi dimensioni), identificativi del dispositivo nell'ambito dell'impianto, di colore verde autorifrangente (disponibile su richiesta)

TWO-DIGIT CODE

Device identification code in large green self-refracting characters (on request)

CODE A DEUX CHIFFRES

Identifiant du dispositif en fonction de l'installation, grandes dimensions, couleur verte (disponible sur demande)

TARGHETTA METALLICA CON:

- CPR
- numero di serie
- dati tecnici
- data di produzione

METAL PLATE WITH:

- CPR no.
- serial no.
- technical data
- date of production

PLAQUE METALLIQUE AVEC :

- CPR
- numéro de série
- données techniques
- date de fabrication



* Con segnali luminosi ausiliari attivi / With active luminous signals / Avec signal lumineux auxiliaire

SEO 1SEV

V AC	230
mA	50
dB(A)1m	max 118*

* Il valore del livello sonoro previsto dalla EN 54-3 è disponibile su richiesta
Acoustic output value according to EN 54-3 available on request
La valeur du niveau sonore prévu par la norme EN 54-3 est disponible sur demande

Codici / Codes

SEO 1SEV/4S-AA / PCS

SEO 1SEV/4S-AA	55303
SEO 1SEV/4S-AA PCS	55333

Sirena evacuazione ad alta potenza per zone industriali, [SEO 1SEV/4S-AA](#) è disponibile per sistema tradizionale e per sistema PCS [SEO 1SEV/4S-AA PCS](#).

Tensione operativa

230V AC +/-10%

Struttura apparecchio

- FRONTALE finestrato con luci di segnalazione a LED
- TROMBA ESPONENZIALE in alluminio con unità magnetodinamica 50W
- CHIUSURA ermetica con chiave a sezione triangolare
- AUTOTEST DI CONTROLLO OGNI 24 H relativo all'assenza di tensione di rete, al livello di tensione batteria, all'impedenza dell'altoparlante. Tre LED di controllo, posizionati sulla scheda elettronica interna, indicano le eventuali anomalie
 - SISTEMA TRADIZIONALE - Un relè con contatto C-NC-NA (normalmente aperto) consente di remotare il segnale di anomalia
 - SISTEMA PCS - Le segnalazioni di anomalia sono riportate sul display della CENTRALE PCS

Funzione

4 livelli di allarme (allertamento, evacuazione, cessato allarme, incendio). Quest'ultimo è attivabile tramite inversione di polarità dalla Centrale Antincendio, secondo la norma UNI EN 54-3.

IMPORTANTE: possibilità di abbinare quattro segnali luminosi ai quattro suoni:

LIVELLO 1 | ALLERTAMENTO | AMBRA

LIVELLO 2 | EVACUAZIONE | ROSSO

LIVELLO 3 | CESSATO ALLARME | VERDE

LIVELLO 4 | INCENDIO | PANNELLO OTTICO

La sirena dispone complessivamente di 8 suoni. Ha un abbinamento ai 4 livelli impostato di default, personalizzabile mediante dip-switch.

Due barrette luminose a led frontale

Una trasparente di due colori (verde e arancio) e una rossa, per le funzioni di controllo:

LED VERDE LAMPEGGIANTE = STATO ATTIVO

presenza rete e funzionamento efficiente del dispositivo. Il colore verde è disattivato durante qualsiasi allarme

LED ARANCIO LAMPEGGIANTE = GUASTO

manca rete elettrica, livello batteria basso o altoparlante interrotto

LED ROSSO LAMPEGGIANTE = ALLARME IN CORSO

Progressività del suono

Questa funzione consente di evitare uno shock a persone vicine all'apparecchio. L'intensità del suono incrementa in 10 sec. dal livello minimo (75 dB) al livello massimo (impostato mediante il POTENZIOMETRO di regolazione). La funzione è disattivabile tramite selettore dip-switch.

Opzioni di sistema

SISTEMA TRADIZIONALE: il dispositivo [SEO 1SEV/4S-AA](#) dispone di un RICEVITORE RADIO del tipo supereterodina 433,92 Mhz - interfacciato con l'apparecchiatura elettronica per i test di prova (allertamento/evacuazione) mediante TELECOMANDO con codice di accesso programmabile ad esigenza dell'utente (n. 1.024 combinazioni), in dotazione con codice standard già memorizzato.

SISTEMA PCS: il dispositivo [SEO 1SEV/4S-AA PCS](#) dispone di un MODULO di COMUNICAZIONE I/O - 4 IN/4 OUT con doppio ISOLATORE DI LINEA. Il componente verrà indirizzato in fase di programmazione per la comunicazione seriale con la CENTRALE SEO SEV SY1 o SY2.

Certificazioni / Certifications

CE 15	EN 54-3	NUMERO CPR / CPR NUMBER / NUMERO CPR
		4S-AA 1328-CPR-0473 4S-AA PCS 1328-CPR-0474

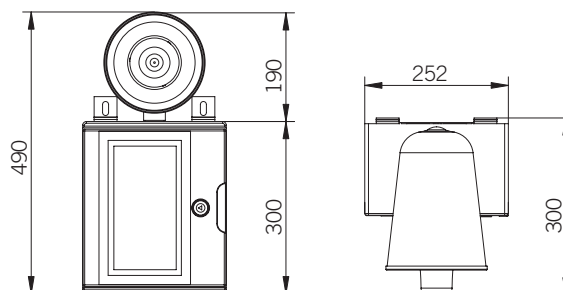

SEO 1SEV



TELECOMANDO

In dotazione nell'imballo per il sistema tradizionale

REMOTE CONTROL

Supplied with product (traditional system)

TELECOMMANDE

Fournie avec le système traditionnel



High power evacuation warning siren for industrial areas, [SEO 1SEV/4S-AA](#) is available for traditional system or for PCS system [SEO 1SEV/4S-AA PCS](#).

Voltages

230V AC +/-10%

Device structure

- Transparent FRONT with LED light
- 50W aluminum magneto-dynamic EXPONENTIAL HORN
- Hermetic CLOSURE with a triangular section spanner
- Self-diagnosis: an automatic control test is carried out every 24 hours relating to absence of mains power supply, low battery charge, interruption of the magneto-dynamic unit. Three LEDs positioned on the PCB indicate the possible anomalies.
 - TRADITIONAL SYSTEM - A relay with a C-NC-NO contact (normally open) allows remote localization of fault signal
 - SERIAL PCS SYSTEM - Any anomalies are reported on the visible display of the PCS CENTRAL UNIT

Function

4 levels of alarm (warning, evacuation, all clear, fire alarm).

The sound relating to the fire alarm is activated by means of polarity inversion by the Fire Alarm Control Box, according to UNI EN 54-3 Norm.

IMPORTANT: it is possible to combine four luminous signals to four sounds:

LEVEL 1 | WARNING | AMBER

LEVEL 2 | EVACUATION | RED

LEVEL 3 | ALL CLEAR | GREEN

LEVEL 4 | FIRE ALARM | LUMINOUS PANEL

A dip-switch allows four sound options to be selected from a total of eight to be combined to the priorities established.

Two front led linear devices

One with transparent dome and bi-colour LED (green and amber) and one with red dome for control functions:

GREEN FLASHING LED LIGHT = INDICATES THAT THE DEVICE IS ON, the presence of electricity and good operation. The green light is deactivated during any alarm situation

AMBER FLASHING LED LIGHT = INDICATES A FAULT: no mains power supply, low battery level or loudspeaker interrupted

RED FLASHING LIGHT = INDICATES AN ALARM SITUATION

Progressive sound

This function, starting from a min. sound output of 75 dB reaching the max. level set within 10 sec., avoids distress to the people in the area. The device has a POTENTIOMETER to regulate the max. sound level required. This function is deactivated by means of the DIP-selector

System options

TRADITIONAL SYSTEM: [SEO 1SEV/4S-AA](#) has a Superheterodyne 433,92 Mhz RADIO RECEIVER - interfaced with the electronic equipment for testing purposes (warning/evacuation) by means of REMOTE CONTROL with a programmable access code as required by the user (1.024 combinations) supplied with a pre-registered standard code

SERIAL PCS SYSTEM: [SEO 1SEV/4S-AA PCS](#) has a COMMUNICATION MODULE I/O - 4 IN/4 OUT - with double LINE ISOLATION.

The component will be addressed in the programming phase for serial communication with the CENTRAL UNIT SEV SY1 or SY2.



Sirène évacuation à haute puissance pour zones industrielles, [SEO 1SEV/4S-AA](#) est disponible pour système traditionnel ou système PCS [SEO 1SEV/4S-AA PCS](#).

Tension d'utilisation

230V AC +/-10%

Structure de l'appareil

- Coffret avec porte à hublot frontal avec visualisation de la signalisation lumineuse LED
- Haut-parleur EXPONENTIEL en aluminium et unité magnétodynamique 50W
- FERMETURE hermétique, clé à section triangulaire
- Auto-contrôle toutes les 24h : l'alimentation de la ligne et le niveau de la batterie, la résistance des haut-parleurs. Trois LED de contrôle indiquant les éventuelles anomalies sont positionnées sur la fiche électronique.
 - SYSTEME TRADITIONNEL - Un relais avec contacts (C-NC-NO), ouvert en fonctionnement normal, permet de remonter le signal d'anomalie.
 - SYSTEME PCS - Les signaux d'anomalie sont reportés sur l'écran de la CENTRALE PCS

Fonction

4 niveaux d'alerte (alerte, évacuation, fin d'alarme, incendie).

Ce dernier est activé par l'inversion de polarité par la centrale incendie, selon la norme UNI EN 54-3.

IMPORTANT : possibilité de connecter quatre signaux lumineux aux quatre sons :

NIVEAU 1 | ALERTE | ORANGE

NIVEAU 2 | EVACUATION | ROUGE

NIVEAU 3 | FIN D'ALARME | VERT

NIVEAU 4 | INCENDIE | TABLEAU VISUEL/OPTIQUE

La sirène dispose d'un total de 8 sons, 4 sons programmables, sélection des sons par micro-interrupteurs.

Deux barres lumineuses à led frontale

Une barre transparente à deux couleurs (vert et orange) et une rouge, pour les fonctions de commande :

LED VERT CLIGNOTANT = STATUT ACTIF, présence du réseau d'alimentation et bon fonctionnement de l'appareil.

La couleur verte est éteinte pendant l'alarme.

LED AMBRE CLIGNOTANT = DEFAILLANCE, absence de réseau, bas niveau de la batterie, haut-parleur interrompu.

LED ROUGE CLIGNOTANTE = ALARME EN COURS

Progressivité du son

Cette fonction permet d'éviter un choc aux personnes proches de l'unité.

L'intensité du son augmente en 10 secondes.

Du niveau minimum (75 dB) au niveau maximal (fixé par un POTENTIOMETRE de régulation). La fonction est désactivée par commutateur dip-switch.

Options du système

SYSTEME TRADITIONNEL : le dispositif [SEO 1SEV/4S-AA](#) a un RECEPTEUR ACOUSTIQUE « superhétérodyne de 433,92 Mhz » interfacé avec l'équipement électronique pour le test (alerte/évacuation) par TELECOMMANDE et code d'accès programmé au besoin de l'utilisateur (n. 1024 combinaisons), fourni avec code standard déjà mémorisé.

SYSTEME PCS : le dispositif [SEO 1SEV/4S-AA PCS](#) a un MODULE DE COMMUNICATION I/O - 4 IN/4 OUT avec double ISOLATION DE LA LIGNE.

La programmation de la communication du dispositif avec la CENTRALE SEO SEV SY1 ou SY2 sera réalisée au préalable par nos soins.

SEO 2SEV



SEO 2SEV/4S-AA
SEO 2SEV/4S-AA PCS

CODICE A DUE CIFRE

Caratteri (di grandi dimensioni), identificativi del dispositivo nell'ambito dell'impianto, di colore verde autorifrangente (disponibile su richiesta)

TWO-DIGIT CODE

Device identification code in large green self-refracting characters (on request)

CODE A DEUX CHIFFRES

Identifiant du dispositif en fonction de l'installation, grandes dimensions, couleur verte (disponible sur demande)

TARGHETTA METALLICA CON:

- CPR
- numero di serie
- dati tecnici
- data di produzione

METAL PLATE WITH:

- CPR no.
- serial no.
- technical data
- date of production

PLAQUE METALLIQUE AVEC :

- CPR
- numéro de série
- données techniques
- date de fabrication



* Con segnali luminosi ausiliari attivi / With active luminous signals / Avec signal lumineux auxiliaire

SEO 2SEV

V AC	230
mA	50
dB(A)1m	max 120*

* Il valore del livello sonoro previsto dalla EN 54-3 è disponibile su richiesta
Acoustic output value according to EN 54-3 available on request
La valeur du niveau sonore prévu par la norme EN 54-3 est disponible sur demande

Codici / Codes

SEO 2SEV/4S-AA / PCS

SEO 2SEV/4S-AA	55300
SEO 2SEV/4S-AA PCS	55300

Sirena evacuazione ad alta potenza per zone industriali, [SEO 2SEV/4S-AA](#) è disponibile per sistema tradizionale e per sistema PCS [SEO 2SEV/4S-AA PCS](#).

Tensione operativa

230V AC +/-10%

Struttura apparecchio

- FRONTALE finestrato con luci di segnalazione a LED
- 2 TROMBE ESPONENZIALI in alluminio con unità magnetodinamiche 50W cad.
- CHIUSURA ermetica con chiave a sezione triangolare
- AUTOTEST DI CONTROLLO OGNI 24 ORE relativo all'assenza di tensione di rete, al livello di tensione batteria, all'impedenza dell'altoparlante. Tre LED di controllo, posizionati sulla scheda elettronica interna, indicano le eventuali anomalie
 - SISTEMA TRADIZIONALE - Un relè con contatto C-NC-NA (normalmente aperto) consente di remotare il segnale di anomalia
 - SISTEMA PCS - Invio di eventuale report di anomalia alla CENTRALE

Funzione

4 livelli di allarme (allertamento, evacuazione, cessato allarme, incendio). Quest'ultimo è attivabile tramite inversione di polarità dalla Centrale Antincendio, secondo la norma UNI EN 54-3.

IMPORTANTE: possibilità di abbinare quattro segnali luminosi ai quattro suoni:

LIVELLO 1 | ALLERTAMENTO | AMBRA

LIVELLO 2 | EVACUAZIONE | ROSSO

LIVELLO 3 | CESSATO ALLARME | VERDE

LIVELLO 4 | INCENDIO | PANNELLO OTTICO

La sirena dispone complessivamente di 8 suoni. L'abbinamento dei suoni ai 4 livelli è impostato di default, personalizzabile mediante dip-switch.

Due barrette luminose a led frontale

Una trasparente di due colori (verde e arancio) e una rossa, per le funzioni di controllo:
LED VERDE LAMPEGGIANTE = STATO ATTIVO presenza rete e funzionamento efficiente del dispositivo. Il colore verde è disattivato durante qualsiasi allarme
LED ARANCIO LAMPEGGIANTE = GUASTO mancanza rete elettrica, livello batteria basso o altoparlante interrotto
LED ROSSO LAMPEGGIANTE = ALLARME IN CORSO

Progressività del suono

Questa funzione consente di evitare uno shock a persone vicine all'apparecchio. L'intensità del suono incrementa in 10 sec. dal livello minimo (75 dB) al livello massimo (impostato mediante il POTENZIOMETRO di regolazione). La funzione è disattivabile tramite selettore dip-switch.

Opzioni di sistema

SISTEMA TRADIZIONALE: il dispositivo [SEO 2SEV/4S-AA](#) dispone di un RICEVITORE RADIO del tipo supereterodina 433,92 Mhz - interfacciato con l'apparecchiatura elettronica per i test di prova (allertamento/evacuazione) mediante TELECOMANDO con codice di accesso programmabile ad esigenza dell'utente (n. 1.024 combinazioni), in dotazione con codice standard già memorizzato.

SISTEMA PCS: il dispositivo [SEO 2SEV/4S-AA PCS](#) dispone di un MODULO di COMUNICAZIONE I/O - 4 IN/4 OUT - con doppio ISOLATORE DI LINEA. Il componente verrà indirizzato in fase di programmazione per la comunicazione seriale con la CENTRALE SEO SEV SY1 o SY2.

Certificazioni / Certifications

CE 15	EN 54-3	NUMERO CPR / CPR NUMBER / NUMERO CPR
		4S-AA 1328-CPR-0475 4S-AA PCS 1328-CPR-0476

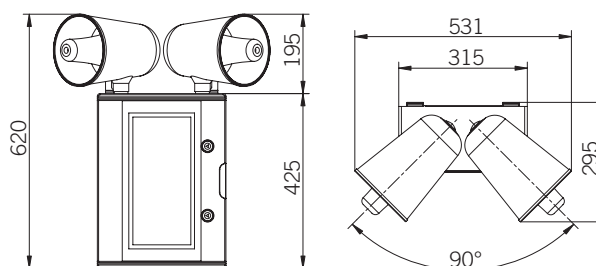

SEO 2SEV



TELECOMANDO

In dotazione nell'imballo per il sistema tradizionale

REMOTE CONTROL

Supplied with product (traditional system)

TELECOMMANDE

Fournie avec le système traditionnel



High power evacuation warning siren for industrial areas, [SEO 2SEV/4S-AA](#) is available for traditional system or for PCS system [SEO 2SEV/4S-AA PCS](#).

Voltages

230V AC +/-10%

Device structure

- Transparent FRONT with LED light
- Two 50W aluminum magneto-dynamic EXPONENTIAL HORNS
- Hermetic CLOSURE with a triangular section spanner
- Self-diagnosis: an automatic control test is carried out every 24 hours relating to absence of mains power supply, low battery charge, interruption of the magneto-dynamic unit. Three LEDs positioned on the PCB indicate the possible anomalies.
 - TRADITIONAL SYSTEM - A relay with a C-NC-NO contact (normally open) allows remote localization of fault signal
 - SERIAL PCS SYSTEM - Any anomalies are reported on the visible display of the PCS CENTRAL UNIT

Function

4 levels of alarm (warning, evacuation, all clear, fire alarm)

The sound relating to the fire alarm is activated by means of polarity inversion by the Fire Alarm Control Box, according to UNI EN 54-3 Norm.

IMPORTANT: it is possible to combine four luminous signals to four sounds:

LEVEL 1 | WARNING | AMBER

LEVEL 2 | EVACUATION | RED

LEVEL 3 | ALL CLEAR | GREEN

LEVEL 4 | FIRE ALARM | LUMINOUS PANEL

A dip-switch allows four sound options to be selected from a total of eight to be combined to the priorities established.

Two front led linear devices

One with transparent dome and bi-colour LED (green and amber) and one with red dome for control functions:

GREEN FLASHING LED LIGHT = INDICATES THAT THE DEVICE IS ON, the presence of electricity and good operation.

The green light is deactivated during any alarm situation

AMBER FLASHING LED LIGHT = INDICATES A FAULT: no mains power supply, low battery level or loudspeaker interrupted

RED FLASHING LIGHT = INDICATES AN ALARM SITUATION

Progressive sound

This function, starting from a min. sound output of 75 dB reaching the max. level set within 10 sec., avoids distress to the people in the area.

The device has a POTENTIOMETER to regulate the max. sound level required. This function is deactivated by means of the DIP-selector

System options

TRADITIONAL SYSTEM: [SEO 2SEV/4S-AA](#) has a Superheterodyne 433,92 Mhz RADIO RECEIVER - interfaced with the electronic equipment for testing purposes (warning/evacuation) by means of REMOTE CONTROL with a programmable access code as required by the user (1.024 combinations) supplied with a pre-registered standard code

SERIAL PCS SYSTEM: [SEO 2SEV/4S-AA PCS](#) has a COMMUNICATION MODULE I/O - 4 IN/4 OUT - with double LINE ISOLATION. The component will be addressed in the programming phase for serial communication with the CENTRAL UNIT SEV SY1 or SY2.



Sirène évacuation à haute puissance pour zones industrielles, [SEO 2SEV/4S-AA](#) est disponible pour système traditionnel ou système PCS [SEO 2SEV/4S-AA PCS](#).

Tension d'utilisation

230V AC +/-10%

Structure de l'appareil

- Coffret avec porte à hublot frontal avec visualisation de la signalisation lumineuse LED
- 2 Haut-parleurs EXPONENTIELS en aluminium et unité magnétodynamique 50W
- FERMETURE hermétique, clé à section triangulaire
- Auto-contrôle toutes les 24h : l'alimentation de la ligne et le niveau de la batterie, la résistance des haut-parleurs. Trois LED de contrôle indiquant les éventuelles anomalies sont positionnées sur la fiche électronique.
 - SYSTEME TRADITIONNEL - Un relais avec contacts (C-NC-NO), ouvert en fonctionnement normal, permet de remonter le signal d'anomalie.
 - SYSTEME PCS - Les signaux d'anomalie sont reportés sur l'écran de la CENTRALE PCS

Fonction

4 niveaux d'alerte (alerte, évacuation, fin d'alarme, incendie).

Ce dernier est activé par l'inversion de polarité par la centrale incendie, selon la norme UNI EN 54-3.

IMPORTANT : possibilité de connecter quatre signaux lumineux aux quatre sons :

NIVEAU 1 | ALERTE | ORANGE

NIVEAU 2 | EVACUATION | ROUGE

NIVEAU 3 | FIN D'ALARME | VERT

NIVEAU 4 | INCENDIE | TABLEAU VISUEL/OPTIQUE

La sirène dispose d'un total de 8 sons, 4 sons programmables, sélection des sons par micro-interrupteurs.

Deux barres lumineuses à led frontale

Une barre transparente à deux couleurs (vert et orange) et une rouge, pour les fonctions de commande :

LED VERT CLIGNOTANT = STATUT ACTIF, présence du réseau d'alimentation et bon fonctionnement de l'appareil.

La couleur verte est éteinte pendant l'alarme.

LED AMBRE CLIGNOTANT = DEFAILLANCE, absence de réseau, bas niveau de la batterie, haut-parleur interrompu.

LED ROUGE CLIGNOTANTE = ALARME EN COURS

Progressivité du son

Cette fonction permet d'éviter un choc aux personnes proches de l'unité.

L'intensité du son augmente en 10 secondes.

Du niveau minimum (75 dB) au niveau maximal (fixé par un POTENTIOMETRE de régulation). La fonction est désactivée par commutateur dip-switch.

Options du système

SYSTEME TRADITIONNEL : le dispositif [SEO 2SEV/4S-AA](#) a un RECEPTEUR ACOUSTIQUE « superhétérodyne de 433,92 Mhz » interfacé avec l'équipement électronique pour le test (alerte/évacuation) par TELECOMMANDE et code d'accès programmé au besoin de l'utilisateur (n. 1024 combinaisons), fourni avec code standard déjà mémorisé.

SYSTEME PCS : le dispositif [SEO 2SEV/4S-AA PCS](#) a un MODULE DE COMMUNICATION I/O - 4 IN/4 OUT avec double ISOLATION DE LA LIGNE.

La programmation de la communication du dispositif avec la CENTRALE SEO SEV SY1 ou SY2 sera réalisée au préalable par nos soins.

STR 1SEV



STR 1SEV/4S-AA
STR 1SEV/4S-AA PCS

Cupole / Domes / Dômes



CODICE A DUE CIFRE

Caratteri (di grandi dimensioni), identificativi del dispositivo nell'ambito dell'impianto, di colore verde autorifrangente (disponibile su richiesta)

TWO-DIGIT CODE

Device identification code in large green self-refracting characters (on request)

CODE A DEUX CHIFFRES

Identifiant du dispositif en fonction de l'installation, grandes dimensions, couleur verte (disponible sur demande)

TARGHETTA METALLICA CON:

- numero di serie
- dati tecnici
- data di produzione

METAL PLATE WITH:

- serial no.
- technical data
- date of production

PLAQUE METALLIQUE AVEC :

- numéro de série
- données techniques
- date de fabrication

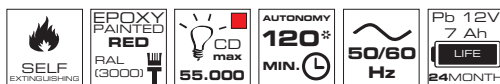
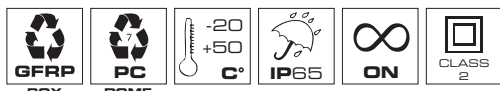

* Con segnali luminosi ausiliari attivi / With active luminous signals / Avec signal lumineux auxiliaire

STR 1SEV

V AC	240
mA	80

Codici / Codes

STR 1SEV/4S-AA / PCS

STR 1SEV/4S-AA	55312	55313	55316
STR 1SEV/4S-AA PCS	55342	55343	55346

Dispositivo luminoso di evacuazione STR 1SEV/4S-AA è disponibile per sistema tradizionale e per sistema PCS STR 1SEV/4S-AA PCS.

Tensione operativa

240V AC +/-10%

Struttura apparecchio

- STROBOFLASH 20J 2F SEGNALATORE LUMINOSO (PC)
- FRONTALE finestrato con luci di segnalazione a LED
- CHIUSURA ermetica con chiave a sezione triangolare
- AUTOTEST DI CONTROLLO OGNI 24 H relativo all'assenza di tensione di rete, al livello di tensione batteria. Tre LED di controllo, posizionati sulla scheda elettronica interna, indicano le eventuali anomalie
 - SISTEMA TRADIZIONALE - Un relè con contatto C-NC-NA (normalmente aperto) consente di remotare il segnale di anomalia
 - SISTEMA PCS - Invio di eventuale report di anomalia alla CENTRALE

Due barrette luminose a led frontale

Una trasparente di due colori (verde e arancio) e una rossa, per le funzioni di controllo:
LED VERDE LAMPEGGIANTE = STATO ATTIVO presenza rete e funzionamento efficiente del dispositivo. Il colore verde è disattivato durante qualsiasi allarme
LED ARANCIO LAMPEGGIANTE = GUASTO mancanza rete elettrica, livello batteria basso
LED ROSSO LAMPEGGIANTE = ALLARME IN CORSO

Opzioni di sistema

SISTEMA TRADIZIONALE: il dispositivo STR 1SEV/4S-AA dispone di un RICEVITORE RADIO del tipo supereterodina 433,92 Mhz - interfacciato con l'apparecchiatura elettronica per i test di prova (allertamento/evacuazione) mediante TELECOMANDO con codice di accesso programmabile ad esigenza dell'utente (n. 1.024 combinazioni), in dotazione con codice standard già memorizzato.

SISTEMA PCS: il dispositivo STR 1SEV/4S-AA PCS dispone di MODULO di COMUNICAZIONE I/O - 4 IN/4 OUT - con doppio ISOLATORE DI LINEA. Il componente verrà indirizzato in fase di programmazione per la comunicazione seriale con la CENTRALE SEO SEV SY1 o SY2.

Certificazioni / Certifications

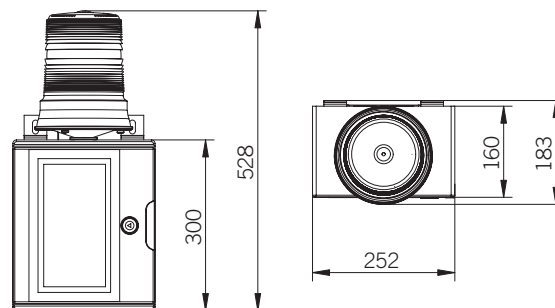

STR 1SEV



TELECOMANDO

In dotazione nell'imballo per il sistema tradizionale

REMOTE CONTROL

Supplied with product (traditional system)

TELECOMMANDE

Fournie avec le système traditionnel



PUNTO RITROVO

cartello 230x290 mm - cod. 55328
CONFORME ALLE NORME UNI 564/18

MEETING POINT

sign 230x290 mm according to UNI 564/18

POINT DE RASSEMBLEMENT

panneau 230x290 mm conforme à la norme UNI 564/18

Codes on request / Codes sur demande



Evacuation luminous device [STR 1SEV/4S-AA](#) is available for traditional system or for PCS system [STR 1SEV/4S-AA PCS](#).

Voltages

240V AC +/-10%

Device structure

- STROBOFLASH 20J 2F BEACON (PC)
- Transparent FRONT with LED lights
- Hermetic CLOSURE with a triangular section spanner
- self-diagnosis: an automatic control test is carried out every 24 hours relating to absence of mains power supply, low battery charge. Three LEDs positioned on the PCB indicate the possible anomalies.
 - TRADITIONAL SYSTEM - A relay with a C-NC-NO contact (normally open) allows remote localization of fault signal
 - SERIAL PCS SYSTEM - Any anomalies are reported on the visible display of the PCS CENTRAL UNIT

Two front led linear devices

One with transparent dome and bi-color LED (green and amber) and one with red dome for control functions:

GREEN FLASHING LED LIGHT = INDICATES THAT THE DEVICE IS ON, the presence of electricity and good operation.

The green light is deactivated during any alarm situation

AMBER FLASHING LED LIGHT = INDICATES A FAULT: no mains power supply, low battery level

RED FLASHING LIGHT = INDICATES AN ALARM SITUATION

System options

TRADITIONAL SYSTEM: [STR 1SEV/4S-AA](#) has a Superheterodyne 433,92 Mhz RADIO RECEIVER - interfaced with the electronic equipment for testing purposes (warning/evacuation) by means of REMOTE CONTROL with a programmable access code as required by the user (1.024 combinations) supplied with a pre-registered standard code

SERIAL PCS SYSTEM: [STR 1SEV/4S-AA PCS](#) has a COMMUNICATION MODULE I/O - 4 IN/4 OUT - with double LINE ISOLATION.

The component will be addressed in the programming phase for serial communication with the CENTRAL UNIT SEV SY1 or SY2.



Dispositif lumineux pour l'évacuation [STR 1SEV/4S-AA](#) est disponible pour système traditionnel ou système PCS [STR 1SEV/4S-AA PCS](#).

Tension d'utilisation

240V AC +/-10%

Structure de l'appareil

- STROBOFLASH 20J 2F DISPOSITIF LUMINEUX (PC)
- Coffret avec porte à hublot frontale avec visualisation de la signalisation lumineuse LED
- FERMETURE hermétique, clé à section triangulaire
- Auto-contrôle toutes les 24h : l'alimentation de la ligne et le niveau de la batterie. Trois LED de contrôle indiquant les éventuelles anomalies sont positionnées sur la fiche électronique.
 - SYSTEME CONVENTIONNEL - Un relais avec CONTACT C-NC-NO (normalement ouvert) vous permet de localiser à distance le signal d'un défaut.
 - SYSTÈME PCS - Les messages d'erreur sont affichés sur le display de la centrale PCS

Deux barres lumineuses à led frontale

Une barre transparente a deux couleurs (vert et orange) et une rouge, pour les fonctions de commande :

LED VERT CLIGNOTANT= STATUT ACTIF, présence du réseau d'alimentation et bon fonctionnement de l'appareil.

La couleur verte est éteinte pendant l'alarme.

LED AMBRE CLIGNOTANT = DEFAILLANCE, absence de réseau, bas niveau de la batterie.

LED ROUGE CLIGNOTANTE = ALARME EN COURS

Options du système

SYSTEME TRADITIONNEL : le dispositif [STR 1SEV/4S-AA](#) a un RECEPTEUR ACOUSTIQUE « superhétérodyne de 433,92 Mhz » interfacé avec l'équipement électronique pour le test (alerte/évacuation) par TELECOMMANDE et code d'accès programmé au besoin de l'utilisateur (n. 1024 combinaisons), fourni avec code standard déjà mémorisé.

SYSTEME PCS : le dispositif [STR 1SEV/4S-AA PCS](#) a un MODULE DE COMMUNICATION I/O - 4 IN/4 OUT avec double ISOLATION DE LA LIGNE.

La programmation de la communication du dispositif avec la CENTRALE SEO SEV SY1 ou SY2 sera réalisée au préalable par nos soins.

PULSANTI PUSH BUTTONS BOUTONS



PULSANTE (RIPRISTINABILE)
Conforme EN 54-11
con CARTELLO NORMATO

WARNING RESETTABLE CALL POINT
According to EN 54-11
with SIGN

BOUTON POUSSOIR (REUTILISABLE)
Conforme EN 54-11
avec PANNEAU AUX NORMES



ALLERTAMENTO
cartello 150x175/A mm - cod. 55325
CONFORME ALLE NORME UNI 7564/16

WARNING*
sign 150x175/A mm
ACCORDING TO UNI 7564/16

ALERTE*
panneau 150x175/A mm
CONFORME AUX NORMES UNI 7564/16

ALLERTAMENTO



EVACUAZIONE
cartello 150x175/E mm - cod. 55326
CONFORME ALLE NORME UNI 7564/16

EVACUATION*
sign 150x175/E mm
ACCORDING TO UNI 7564/16

EVACUATION*
panneau 150x175/E mm
CONFORME AUX NORMES UNI 7564/16

EVACUAZIONE



INCENDIO
cartello 150x175/I mm - cod. 55327
CONFORME ALLE NORME UNI 7564/16

FIRE ALARM*
sign 150x175/I mm
ACCORDING TO UNI 7564/16

INCENDIE*
panneau 150x175/I mm
CONFORME AUX NORMES UNI 7564/16

ALLARME
ANTINCENDIO

* Codes on request / Codes sur demande



EX 025 PAG
EX 035 PAG PCS



II 2GD
Ex d IIC T6 Gb
Ex tb IIIC T85°C Db IP66

Codici / Codes

PULSANTI / PUSH BUTTONS / BOUTONS • TRADIZIONALE / TRADITIONAL / TRADITIONNEL

ALLERTAMENTO / WARNING / ALERTE 55320**
EVACUAZIONE / EVACUATION / EVACUATION 55321**
INCENDIO / FIRE ALARM / INCENDIE 55323**
ATEX EX 025 PAG 96699

• PCS

ALLERTAMENTO / WARNING / ALERTE 55362**
EVACUAZIONE / EVACUATION / EVACUATION 55361**
INCENDIO / FIRE ALARM / INCENDIE 55319**
ATEX EX 035 PAG PCS 96700

** Con cartello normato / With sign / Avec panneau

Pulsante manuale ripristinabile

- Materiale termoplastico colore rosso
 - Pittogramma europeo universale
 - Protezione: IP 66
 - Contatto interno: 2 x C-NC-NA in parallelo
- Nel SISTEMA PCS: modulo di comunicazione indirizzato

Azionamento

Per azionare il pulsante basta premere sul punto indicato nell'elemento plastico infrangibile (conforme alla EN 54-11). Una volta attivato il pulsante genera un interrupt ad alta priorità che permette alla sirena di rispondere in modo veloce.

Ripristino dopo un'attivazione

Per ripristinare il pulsante, inserire la chiave in dotazione (lato con la biforcazione) e far slittare la parte bassa del coperchio verso il basso senza sollevarla. Sempre senza sollevarla riportare la parte bassa del coperchio nella posizione originale. Questa operazione riporterà in posizione anche l'elemento infrangibile.

Pulsante ATEX a rottura vetro

- Corpo in lega di alluminio esente da rame
- Verniciatura poliestere RAL 3020
- Protezione: IP 66

Nel SISTEMA PCS: modulo di comunicazione indirizzato

Azionamento

Per azionare il pulsante basta rompere il vetro con l'apposito martelletto fornito a corredo. Una volta attivato, il pulsante genera un interrupt ad alta priorità che permette alla sirena collegata di rispondere in modo veloce.

Ripristino dopo un'attivazione

Per ripristinare il pulsante occorre sostituire il componente: 96698 - EX 015 VETRO PAG. Questa operazione renderà di nuovo attivo il pulsante.

Certificazioni / Certifications



0477



CESI 05 ATEX 062

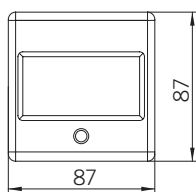

PULSANTE MANUALE
MANUAL CALL POINT
BOUTON MANUEL



0,30

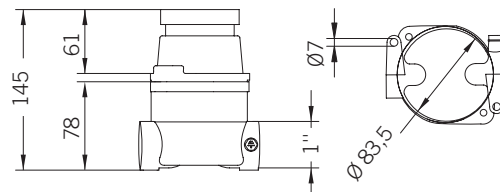

EX 025 PAG
EX 035 PAG PCS



0,87



Manual resettable call point

Red thermoplastic housing • universal European pictogram
• protection grade : IP 66 • internal contacts: 2 x C-NC-NO in parallel
For SERIAL PCS SYSTEM: communication module

Activation - The call point is operated simply by pressing the center of the re-settable plastic element (according to EN 54-11). Once operated the call point generates a high priority interrupt signal, which allows the siren to respond very quickly.

Resetting after activation - To reset the call point after it has been activated, insert the supplied key and slide the lower cover down. Slide the lower cover up, the non-frangible element will be reset.

ATEX explosion proof emergency switch

Housing in copper-free aluminum alloy • Polyester paint RAL 3020 • Protection grade: IP 66
For SERIAL PCS SYSTEM: communication module

Activation - The 'break glass' emergency switch is activated by striking the glass with the attached mini-hammer. Once operated it generates a high priority interrupt signal, which allows the siren to respond very quickly.

Resetting after activation - To reset the emergency switch replace the glass part no. 96698 - EX 015 VETRO PAG. This will re-activate the switch.



Boutons poussoirs manuels reutilisables

En thermoplastique rouge • pictogramme universel européen
• protection : IP 66 • Contacts internes : 2 x C-NC-NO en parallèle
Dans SYSTÈME PCS : module de communication programmé

Activation - Utilisation : appuyez simplement sur le bouton sur le point référencé dans la plastique incassable (conforme EN 54-11). Une fois activé, le bouton génère une interruption de haute priorité qui permet à la sirène de répondre rapidement.

Rétablissement après activation - Pour le rétablissement après une activation du bouton, insérer la clé fournie (du côté de la bifurcation) et faites glisser la partie inférieure du couvercle vers le bas sans soulever.

Rapporter la partie inférieure du couvercle à la position initiale, sans la soulever.

Cette opération rétablira aussi la position de l'élément incassable.

Bouton poussoir ATEX à bris de verre

Corps en alliage d'aluminium sans cuivre • Vernissage polyester RAL 3020 • Protection IP66

Dans SYSTÈME PCS : module de communication programmé

Activation - Briser le verre à l'aide du marteau attaché. Une fois activé, le bouton génère une interruption de haute priorité qui permet à la sirène de répondre rapidement.

Rétablissement après activation - Pour rétablir le bouton poussoir ATEX, il faut remplacer le verre : 96698 EX 015 VETRO PAG. Le bouton sera ensuite de nouveau actif.

BOX COMANDI BCP PCS BCP PCS CONTROL BOX BOITIER DE COMMANDE BCP PCS



BOX BCP PCS



BOX BCP PCS LS



- Il **BCP PCS** - box comandi presidiati, unitamente alla centrale SEV SY PCS, devono essere installati in zona presidiata
- Il **BCP PCS** consente di attivare le sirene premendo semplicemente i pulsanti di attivazione, chiaramente distinti:

■ **ALLERTAMENTO GENERALE**

■ **EVACUAZIONE GENERALE**

■ **CESSATO ALLARME GENERALE**

■ **STOP per la tacitazione delle sirene**

Sono disponibili (su richiesta) versioni di **BOX PCS SPECIALI** per facilitare la gestione LOCALE delle varie ZONE da zona presidiata, con pulsanti dedicati a:

ALLERTAMENTO - EVACUAZIONE I ZONA 1
 ALLERTAMENTO - EVACUAZIONE I ZONA 2
 ALLERTAMENTO - EVACUAZIONE I ZONA 3
 ALLERTAMENTO - EVACUAZIONE I ZONA 4, ecc.
 Oltre a: ALLERTAMENTO, EVACUAZIONE, CESSATO ALLARME GENERALE e STOP.
 L'esecuzione è dedicata in base all'esigenza dell'impianto secondo la filosofia di GESTIONE dell'EMERGENZA a PIÙ FASI (D.M. 10/03/98).

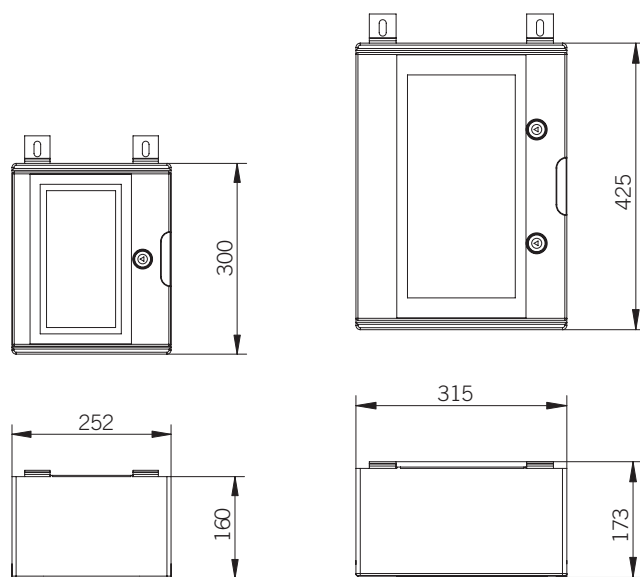

BOX BCP PCS

BOX BCP PCS LS



- The **BCP PCS** control box together with the SEV SY PCS central unit should be ideally installed in a manned area.
- The **BCP PCS** control box allows the activation of the sirens by pressing the specific button:

■ **GENERAL WARNING**

■ **GENERAL EVACUATION**

■ **GENERAL ALL CLEAR**

■ **STOP for sirens reset**

SPECIAL BCP PCS control boxes are available (on request) to facilitate the LOCAL area management with specific push buttons:
 WARNING - EVACUATION / AREA 1
 WARNING - EVACUATION / AREA 2
 WARNING - EVACUATION / AREA 3
 WARNING - EVACUATION / AREA etc.
 In addition: GENERAL WARNING, GENERAL EVACUATION, GENERAL ALL CLEAR and STOP.



- Le boîtier de commande **BCP PCS** accompagné de la centrale SEV SY PCS, doit être installé de préférence dans une zone surveillée.
- Le **BCP PCS** permet d'activer les sirènes par la pression des boutons d'activation :

■ **ALERTE GENERALE**

■ **EVACUATION GENERALE**

■ **BOUTON POUSSOIR FIN D'ALARME GENERALE**

■ **LA CLE stop du système**

Sont disponibles (sur demande) des versions de **BOÎTIERS DE COMMANDE SPECIFIQUE** pour faciliter la gestion LOCALE des ZONES, avec boutons dédiés à :
 ALERTE - EVACUATION / ZONE 1
 ALERTE - EVACUATION / ZONE 2
 ALERTE - EVACUATION / ZONE 3
 ALERTE - EVACUATION / ZONE 4 etc.
 En plus : ALERTE GENERALE, EVACUATION GENERALE, FIN D'ALARME GENERALE et STOP.

Codici / Codes

BOX COMANDI BCP PCS
 BCP PCS CONTROL BOX
 BOITIER DE COMMANDE BCP PCS

BOX BCP PCS 55365
 BOX BCP PCS LS 55366

CENTRALE PCS PCS CENTRAL UNIT CENTRALE PCS



CENTRALE SEO SEV PCS
SEO SEV PCS CENTRAL UNIT
CENTRALE SEO SEV PCS



DISPLAY

Dopo ogni allarme o anomalia il buzzer della centrale si attiva e spegnendolo, con l'apposito pulsante di tacitazione buzzer (livello 1), si acquisiscono gli eventi leggibili sul display. Nella fase finale, dopo il suono di cessato allarme o la tacitazione diretta delle sirene (STOP), occorre eseguire il ripristino del sistema attraverso l'apposito pulsante (livello 2), solo dopo aver riportato in condizione di riposo gli attivatori.

DISPLAY

After each alarm or anomaly, the buzzer of the central unit is activated. Turning it off with the appropriate button to mute the buzzer (level 1), all alarms/anomalies can be read on the display. After the all clear or the direct muting of the sirens (STOP), the system must be reset through the appropriate pushbutton (level 2), only after resetting the activators in nonoperative condition.

ECRAN

Après chaque alarme ou anomalie, le buzzer de la centrale s'active puis s'éteint via le bouton poussoir dédié (niveau 1), les événements sont enregistrés et affichés sur l'écran. Dans la phase finale, après l'arrêt du son de fin d'alarme ou l'extinction des sirènes (STOP), il est nécessaire de rétablir le système via le bouton poussoir dédié (niveau 2), seulement après avoir remis en conditions de repos les activateurs.

Codici / Codes

CENTRALE SEO SEV PCS
SEO SEV PCS CENTRAL UNIT
CENTRALE SEO SEV PCS

CENTRALE SEV SY1 AA PCS 55351
CENTRALE SEV SY2 AA PCS 55352

La CENTRALE SEV SY1 AA PCS gestisce una linea seriale mentre la CENTRALE SEV SY2 AA PCS gestisce fino a due linee seriali (loop 2500 m), ed un massimo di 254 dispositivi (sirene, pulsanti e altri moduli accessori), tramite i moduli indirizzati.

1. Il modulo indirizzato contenuto nella sirena è dotato di isolatore di linea ed è in grado di gestire 4 segnali di ingresso e 4 segnali di uscita, mentre il modulo indirizzato contenuto dal pulsante dispone di unico ingresso NA.

La CENTRALE dialoga con i moduli indirizzati e integrati nelle sirene e nei pulsanti e riceve da essi le informazioni.

Qualora sia necessario gestire una quantità superiore di punti segnale, occorrerà utilizzare più CENTRALI SEV SY che potranno essere collegate tra loro in rete e gestite totalmente dalla Centrale definita primaria.

2. Nel progettare l'impianto quindi si dovrà tenere conto del numero di moduli indirizzati presenti nei dispositivi SIRENE (1 x 4 IN-4 OUT), BOX COMANDI (4), PULSANTI (1) ed effettuare il calcolo: es. 20 sirene e 30 pulsanti = 50 moduli indirizzati.

3. La centrale PCS effettua un controllo continuo dei dispositivi seriali, attraverso i moduli indirizzati, anche in assenza della loro attivazione, a quattro livelli:

- PRESENZA RETE DI ALIMENTAZIONE (controllo permanente 24 ore su 24)
- EFFICIENZA BATTERIA (controllo ogni 24 ore)
- FUNZIONALITÀ SIRENE (controllo ogni 24 ore)
- INTERRUZIONE DI LINEA (controllo permanente 24 ore su 24)

La centrale inoltre controlla lo stato di carica ed efficienza delle proprie batterie interne. Ogni anomalia viene rilevata e segnalata in tempo reale e le indicazioni sono riportate sul display grafico 240x64 pixel della centrale, memorizzate (sino a 1.000 eventi) e stampate se è connessa una stampante:

**DATA E ORA DELLA RILEVAZIONE • NUMERO IDENTIFICATIVO
UBICAZIONE DEL DISPOSITIVO • TIPO DI ANOMALIA DEL DISPOSITIVO**

4. La Centrale gestisce inoltre:

- 3 USCITE RELÈ in scambio libero per l'attivazione di dispositivi ausiliari
- 5 INGRESSI N.A. per ricevere comandi da contatti puliti esterni
- 1 PORTA SERIALE RS 232 per la programmazione tramite PC o la connessione della stampante o del modem
- 1 PORTA SERIALE RS 485 per il collegamento a ripetitori display remoti e a moduli di interfaccia I/O
- 2 PORTE SERIALI per il collegamento seriale di una rete di centrali sino al massimo di 64
- ARMADIO METALLICO
- Dimensioni: 385 x 520 x 110 mm



The SEV SY1 AA PCS CENTRAL UNIT directs one serial line, the SEV SY2 AA PCS CENTRAL UNIT directs two serial lines (loop 2500 m), up to a maximum of 254 devices (sirens, call points and other accessories) by means of signal concentrators.

1. The signal concentrator is an interface module between the siren and the central unit; it is equipped with a line separator and can control 4 incoming and 4 outgoing signals.

The signal concentrator of a call point has only one NO input. The central unit dialogues with the signal concentrators, integrated in sirens and call points reply accordingly.

If a greater number of points must be managed, more CENTRAL UNITS SEV SY are required. They can be networked together and controlled by the CENTRAL UNIT defined as primary.

2. At the time of planning the installation, therefore, the number of concentrators in each device must be taken into consideration: SIREN (1 x 4 IN - 4 OUT), CONTROL BOX (4), CALL POINTS (1) and calculate: e.g. 20 sirens and 30 call points = 50 concentrators

3. The PCS CENTRAL UNIT carries out a constant control of the serial devices at four levels, even when they are not activated:

- AVAILABILITY OF MAINS POWER (24 hours constant control)
- BATTERY EFFICIENCY (one control every 24 hours)
- SIRENS EFFICIENCY (one control every 24 hours)
- LINE INTERRUPTION (24 hours constant control)

The central unit also controls the charge state and efficiency of its own internal batteries.

Any anomaly is recorded and transmitted in real-time on the graphic display (240x64 pixel) of the central unit, stored (up to 1000 events) and a report is printed with the following information:

- DATE AND TIME OF ANOMALY
- IDENTIFICATION NUMBER OF THE DEVICE
- POSITION OF THE DEVICE
- TYPE OF ANOMALY

4. The central unit also controls:

- 3 RELAY OUTPUTS for the activation of auxiliary devices
- 5 NO INPUTS to receive commands from external contacts
- 1 RS 232 SERIAL PORT for programming and handling the system via PC or for the connection to a printer or a modem
- 1 RS 485 SERIAL PORT for the connection to remote repeat displays and I/O interface modules
- 2 SERIAL PORTS for the serial connection of a network of central units (up to 64 devices)
- METAL ENCLOSURE
- Dimensions: 385 x 520 x 110 mm



La CENTRALE SEV SY1 AA PCS gère une ligne en série et la CENTRALE SEV SY2 AA PCS gère deux lignes en série (loop) et un maximum de 254 points (sirènes, boutons poussoirs et différents accessoires).

1. Le concentrateur du signal de la sirène est un module d'interface entre la sirène et la centrale. L'isolateur de ligne peut gérer 4 signaux en entrée et 4 signaux en sortie, le concentrateur du signal du bouton poussoir a une seule entrée NO. La CENTRALE dialogue avec les concentrateurs du signal qui sont intégrés dans les sirènes et dans les boutons poussoirs et reçoit les informations. Au cas où il serait nécessaire de contrôler une quantité supérieure de points, il faudra utiliser plusieurs centrales PCS, qui pourront être mises en réseau et gérées par une définie primaire.

2. Pour le plan d'installation il faut donc considérer le nombre de concentrateurs de chaque SIRENE (1 x 4 IN-4OUT), BOITIER DE COMMANDE (4), BOUTONS POUSSOIRS (1) et effectuer le calcul : ex. 20 sirènes et 30 boutons poussoirs = 50 concentrateurs

3. La centrale PCS effectue un contrôle continu des dispositifs en série, même quand ils ne sont pas actifs, sur quatre niveaux :

- PRESENCE RESEAU D'ALIMENTATION (contrôle permanent 24 heures sur 24)
- NIVEAU BATTERIE (contrôle toutes les 24 heures)
- FONCTIONNALITE SIRENE (contrôle toutes les 24 heures)
- INTERRUPTEUR DE LIGNE (contrôle permanent 24 heures sur 24)

La centrale contrôle l'état de charge de ses batteries intérieures. Toute anomalie est relevée et signalée immédiatement et les indications sont visualisées sur l'afficheur graphique 240x64 pixel de la centrale, elle mémorise (jusqu'à 1000 événements) et imprime sous forme de rapport si connectée à une imprimante :

- DATE ET HEURE DE LA REMARQUE
- NUMERO DU DISPOSITIF
- POSITION DU DISPOSITIF
- TYPE D'ANOMALIE DU DISPOSITIF

4. La centrale gère aussi :

- 3 SORTIES RELAIS échange libre pour l'activation des dispositifs auxiliaires
- 5 ENTrees N.O. pour recevoir des commandes par les contacts externes
- 1 PORT SERIE RS 232 pour la programmation via PC ou la connexion d'une imprimante ou d'un modem
- 1 PORT SERIE RS 485 pour le raccordement aux répéteurs afficheurs à distance et des modules d'interface I/O
- 2 PORTS SERIE pour la connexion en série d'un réseau d'alimentation, jusqu'à un maximum de 64 dispositifs
- ARMOIRE METALLIQUE
- Dimensions : 385 x 520 x 110 mm

ACCESSORI PCS PCS ACCESSORIES ACCESSOIRES PCS



DR SEV SY PCS

Codici / Codes

ACCESSORI PCS / PCS ACCESSORIES / ACCESSOIRES PCS

SCHEDA COM CENTRALE	41550
DR SEV SY PCS	55370
DR SEV SY AA PCS	55371
BOX CONNESSIONE	41541
BOX INTERFACCIA	41543
INTERFACCIA ETHERNET	41544

Suoni disponibili

Un dip-switch all'interno dei dispositivi consente di selezionare quattro suoni da otto esistenti ed abbinarli alle priorità definite (di default la sirena viene programmata con i primi quattro suoni).

Available sounds

An internal dip-switch allows the selection of four sounds (from a total of eight) to be combined to the priorities established (by default the siren is programmed with the first four sounds).

Sons disponibles

Un micro-interrupteur à l'intérieur des dispositifs permet de sélectionner 4 sons parmi les 8 existants ainsi que d'en définir les priorités (par défaut la sirène est programmée avec les 4 premiers sons).

SW3 suono / sound / son 1: Intermittente / Intermittent / Intermittent
490Hz (0,5 sec) - 0Hz (1 sec)

SW3 suono / sound / son 2: Bitonale / Two-tone / Bitonal
490Hz (0,5 sec) - 610Hz (0,5 sec)

SW3 suono / sound / son 3: Continuo / Continuous / Linéaire
610Hz

SW3 suono / sound / son 4: Sweep 2450Hz - 2850Hz - 2450Hz
(ciclo / cycle / cycle 0,5 sec)

SW3 suono / sound / son 5: Sweep 1200Hz - 500Hz
(ciclo / cycle / cycle 1 sec)

SW3 suono / sound / son 6: Bitonale / Two-tone / Bitonal
554Hz (0,1 sec) - 440Hz (0,4 sec)

SW3 suono / sound / son 7: BELL Frequenza Base / Base Frequency /
Fréquence de Base 1400Hz

SW3 suono / sound / son 8: Intermittente / Intermittent / Intermittent
950Hz (0,5 sec) - 0Hz (0,5 sec) - 950Hz (0,5 sec) - 0Hz (0,5 sec) - 950Hz
(0,5 sec) - 0Hz (2 sec)

Scheda comunicazione centrale

La scheda viene inserita nella Centrale SEV SY1-SY2 per consentire la comunicazione tra più centrali (max 64). In un impianto di grandi dimensioni, dove occorre installare più centrali, sarà quindi possibile gestire tutti i loop da ogni singola centrale e prevedere (da programmazione) l'assegnazione di centrale MASTER e centrale SLAVE. **Le centrali andranno collegate con cavo RS 485 a loop chiuso per garantire il controllo della linea.**

Pannello remoto di ripetizione

Il Pannello ripetitore **DR SEV SY PCS** è il dispositivo che ripete gli eventi acquisiti dalla Centrale. Consente la visualizzazione dei messaggi sul display e l'esecuzione di tutte le funzioni di attivazione, tacitazione e ripristino sistema come da centrale SEV SY AA PCS. Display grafico LCD 240X 64 PIXEL.

Alimentazione da centrale SEV SY 1-2 (fino a 100 m). Il modello **DR SEV SY AA PCS** dispone di alimentatore-carica batterie 230V - 750 mA che viene previsto per posizionamenti a oltre 100 m di distanza dalla Centrale. **Il pannello viene collegato alla centrale con linea dedicata RS 485.**

Dimensioni 330 x 250 x 90 mm.

Box connessione

Modulo di interconnessione con CENTRALE PCS SIRENA per attivazione allarme da un contatto NA proveniente da un'altra centrale, rivelatore o sensore di altro impianto esistente.

Box interfaccia centrale antincendio

Modulo di interfaccia tra CENTRALE PCS EVACUAZIONE e CENTRALE ANTINCENDIO per l'attivazione del suono INCENDIO tramite inversione di polarità, come definito dalla norma UNI EN 54-3.

Interfaccia rete Ethernet

Il componente MOXA, consente di connettere la Centrale PCS alla rete interna per il collegamento di PC. Caricando il programma della Centrale sul PC si potrà visualizzare il frontpanel della Centrale, scaricare e stampare gli eventi, intervenire sulla programmazione per le modifiche: aggiunte, spostamenti o esclusione di componenti.



Central unit communication interface

The interface is inserted in the SEV SY1-SY2 Central Unit to allow communication between more central units (max. 64). In large scale installations, with more central units, it will be possible to manage all loop from each central unit and to determine (with programming) the MASTER and the SLAVE central unit. **Central units should be close-loop connected with RS 485 cable, to ensure line monitoring.**

Remote control panel

The remote control panel **DR SEV SY PCS** allows repetition of the events, acquired from the Central Unit. It is possible to display messages, activation functions and system reset, as from to SEV SY AA PCS Central Unit.

LCD 204X 64 PIXEL Graphic display.

Power supply from SEV SY 1-2 central unit (up to 100 m)

DR SEV SY AA PCS has a power supply-battery charger 230V - 750 mA for positioning over 100m from Central Unit. **The panel is connected to the central unit by means of a RS485 dedicated line.**

Dimensions 330 x 250 x 90mm.

Connection box

Interconnection module with SIRENA PCS CENTRAL UNIT for alarm activation from a NO contact of another central unit.

Interface module for fire alarm central unit

Interface module between EVACUATION PCS CENTRAL UNIT and FIRE ALARM CENTRAL UNIT for the activation of the FIRE ALARM sound, through polarity inversion according to EN 54-3.

Ethernet network interface

The MOXA element allows connection of the central unit to the internal network for PC connection. Loading the program of the central unit, it is possible to display the front panel of the central unit, to download and print the events and to modify the programming: adds, relocation or exclusion of components.



Fiche communication centrale

La fiche s'insère dans la centrale SEV SY1-SY2 pour permettre la communication avec d'autres centrales (max 64). Dans une installation de grandes dimensions nécessitant plusieurs centrales, il est possible de gérer toutes les boucles à partir d'une seule centrale, l'assignation des sirènes MASTER et SLAVE doit être faite au moment de la programmation. **Les centrales seront connectées avec un câble RS 485 à boucle fermée afin de garantir le contrôle de la ligne.**

Panneau de répétition à distance

Le panneau de répétition **DR SEV SY PCS** est le dispositif permettant la répétition des événements enregistrés par la centrale. Il permet la visualisation des messages sur l'écran et l'exécution de toutes les fonctions d'activation, d'arrêt et de restauration du système comme depuis la centrale SEV SY AA PCS.

Ecran LCD 240x64 pixel.

Alimentation par la centrale SEV SY 1-2 (jusqu'à 100 mètres). Le modèle **DR SEV SY AA PCS** dispose de batterie rechargeable 230V - 750 mA prévus lorsqu'ils sont installés à plus de 100 mètres de la centrale. **Le dispositif est connecté à la centrale par un câble dédié RS 485.**

Dimensions 330 x 250 x 90 mm.

Boîte de connexion

Module d'interconnexion avec la CENTRALE PCS SIRENA pour activation de l'alarme via un contact NO provenant d'une autre centrale, détecteur ou capteur d'une autre installation.

Boîte interface centrale anti-incendie

Module d'interface entre la CENTRALE PCS EVACUATION e la CENTRALE ANTI-INCENDIE pour l'activation du son par inversion de polarité comme prévu dans la norme UNI EN 54-3.

Interface réseau Ethernet

Le composant MOXA permet de connecter la centrale PCS au réseau interne par l'intermédiaire d'un PC. Par le chargement du programme de la centrale sur le PC, il sera possible de visualiser l'affichage de la centrale, charger et imprimer les événements, intervenir sur la programmation en cas de modifications : ajouts, déplacements et suppressions de composants.

GAMMA FA

LUCI E SIRENE OMOLOGATE EN54

Quando la sicurezza è una priorità, assicurarsi che i dispositivi di segnalazione più appropriati vengano utilizzati, diventa un lavoro di responsabilità. La gamma FA (Fire Alarm) è stata sviluppata per fare proprio questo: fornire agli utenti finali dispositivi di segnalazione di alta qualità e approvati EN54. La nostra gamma di dispositivi acustici (SIR-E FA), luminosi (SLR FA, XLF FA) e acustico/luminosi (SIR-E LED FA) ha ottenuto l'omologazione EN54-3/EN54-23. I suoni certificati sono stati selezionati per soddisfare i clienti più esigenti. I dispositivi certificati sono stati progettati con una tipologia di lampeggio adatta alle applicazioni di allarme antincendio concepiti per migliorare la visibilità anche nelle condizioni più critiche.

La normativa EN54 sul rilevamento incendio e sistemi di allarme antincendio, è lo standard che specifica i requisiti dei dispositivi e i test di laboratorio da eseguire per ogni componente per il **rilevamento incendio e sistemi di allarme antincendio** e permette la libera circolazione dei dispositivi tra i paesi del mercato dell'**Unione Europea**.

La normativa è stata sviluppata e approvata dal **Comitato Europeo per la standardizzazione**.

Questa normativa è ampiamente riconosciuta in tutto il mondo e in molti paesi al di fuori dell'**Unione Europea**. È riconosciuta anche nei paesi latino-americani, come in Brasile, nei paesi africani e asiatici e diverse isole dell'Oceano Pacifico.



FA RANGE

EN54 APPROVED FIRE ALARM BEACONS AND SOUNDERS

When safety is a priority, making sure the most appropriate signaling devices are used, becomes a job of responsibility. The FA range (Fire Alarm) range has been developed to do just this: deliver end-users with high-quality EN54 approved signaling devices. Our range of sounders (SIR-E FA), beacons (SLR FA, XLF FA) and beacon/sounders (SIR-E LED FA) have been granted EN54-3/EN54-23 approval. The certified tones have been selected to satisfy the most demanding customers. The certified beacons have been engineered with a flashing pattern optimized for fire alarm applications enhancing visibility even under the most critical conditions.

The EN54 fire detection and fire alarm systems is a mandatory standard that specifies requirements and laboratory test for every component of **fire detection and fire alarm system** and it allows the free movement of construction products between countries of the **European Union** market.

It was developed and approved by **European Committee for Standardization**.

This standard is widely recognized around the world for several countries outside of **European Union**. It is recognized in Latin American countries, Brasil, African and Asian countries and several islands in the Pacific Ocean.



GAMME FA

DISPOSITIFS LUMINEUX ET SIRENES CERTIFIES SELON EN54

Quand la sécurité est une priorité, il faut s'assurer que les dispositifs de signalisation soient les plus adaptés, là commence notre responsabilité !



La gamme FA (Alarme Incendie) offre aux utilisateurs finaux des dispositifs de signalisation certifiés selon la norme EN54.

Notre gamme de sirènes (SIR-E FA) et dispositifs lumineux et/ou acoustique (SLR FA, XLF FA, SIR-E LED FA) répond aux normes EN54-3/EN54-23. Les tonalités ont été choisies de façon à satisfaire les demandes de nos clients. Les effets lumineux de nos dispositifs sont optimisés pour les **systèmes d'alarmes incendies**, permettant une visibilité même dans les situations les plus critiques.

La conformité de nos produits aux normes de l'EN54 fait d'eux des dispositifs pouvant être installés partout dans l'**Union Européenne**. Cette norme a été mise en place par le **Comité Européen de Normalisation**. Elle est aussi reconnue dans le reste du monde comme en Amérique latine, en Afrique, en Asie et dans certaines îles de l'Océan Pacifique.



Secondo il Regolamento CPR (Construction Products Regulation) 305/2011/UE, è obbligatorio che i sistemi di Rilevamento Incendi e di Allarme Antincendio abbiano la certificazione EN54 rilasciata da un Ente notificato per la Certificazione.

-  According to the Construction Products Regulation (CPR) 305/2011/EU, it is mandatory that Fire Detection and Fire Alarm equipments are certified under EN54 Standard by a notified Certification Body.
-  Selon le Construction Products Regulation (CPR) 305/2011/UE, il est obligatoire que les systèmes de Détection Incendie soient reconnus comme conformes à la norme EN54 par un Organisme notifié à le faire.



UN CONCEPT... ONE CONCEPT... UN CONCEPT...

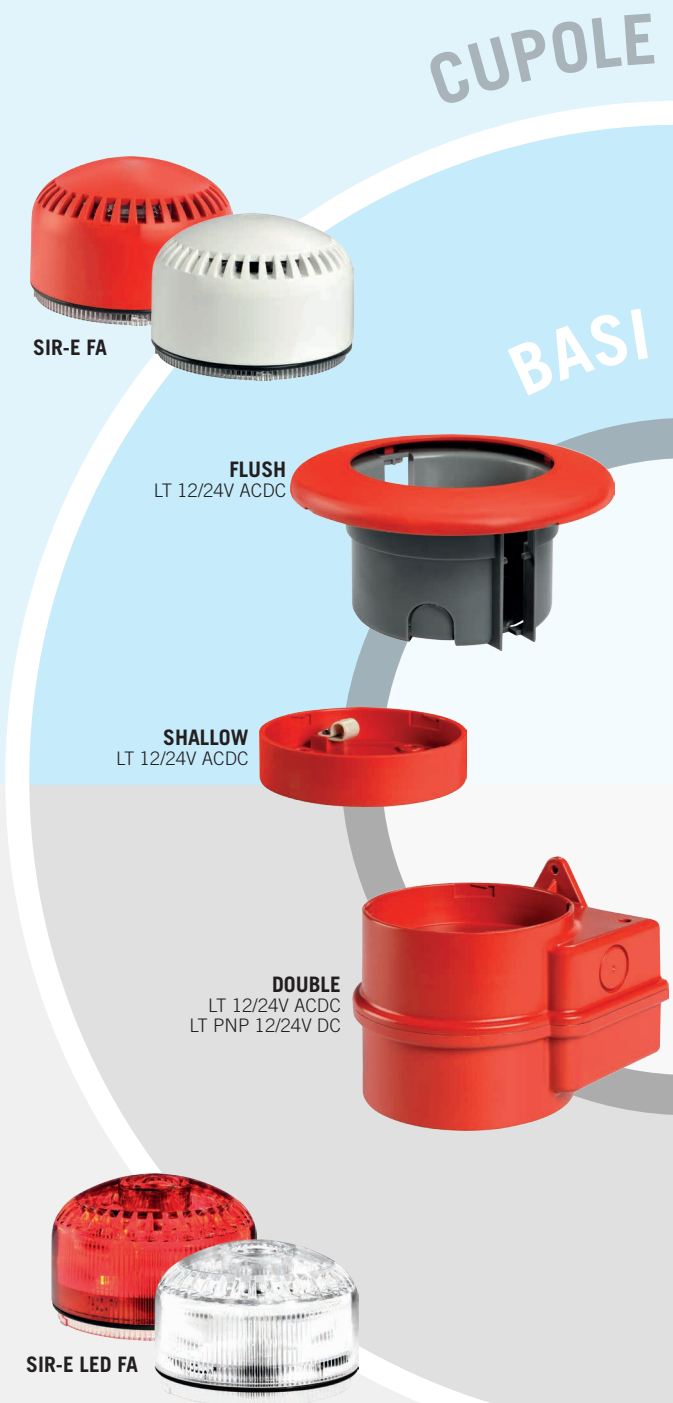

Le basi sono disponibili in / All bases available in / Les bases sont disponibles en :

aiIRED Rosso / Red / Rouge RAL 3000
aiIWHITE Bianco / White / Blanc RAL 9003

La grafica mostra gli esempi di combinazione **aiIRED**.

Chart above showing **aiIRED** combinations examples.

Le graphique montre les exemples de combinaisons **aiIRED**.

DOMES

BASES



SLR FA



DEEP
LT 12/24V ACDC
LT PNP 12/24V DC



WALL
LT 12/24V ACDC
LT PNP 12/24V DC



POLE
LT 12/24V ACDC
LT PNP 12/24V DC



XLF FA

SLR FA + DEEP

SLR FA + SHALLOW

SLR FA + POLE



SLR FA + FLUSH



SLR FA + SIR-E FA + DOUBLE



SLR FA + WALL

XLF FA + DEEP

XLF FA + SHALLOW

XLF FA + POLE



XLF FA + FLUSH



XLF FA + SIR-E FA + DOUBLE



XLF FA + WALL

**...INFINITE SOLUZIONI
...ENDLESS SOLUTIONS
...DES SOLUTIONS INFINIES**

SIR-E FA



SIR-E FA

100 dB max - EN54-3

Cupole / Domes / Dômes

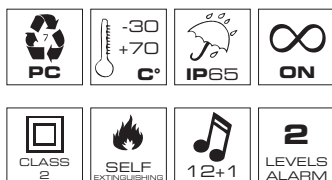

SIR-E FA

V DC	12 ÷ 24
mA	45 35
dB(A)1m	80 ÷ 100

Può essere installato con
Can be installed with
Peut être assemblé à

Basi / Bases



	EN54-3	EN54-3	EN54-3
	SHALLOW	DEEP	WALL
12/24V ACDC	✓	✓	✓
PNP 12/24V DC	✗	✗	✓
	FLUSH	DOUBLE	POLE
		EN54-3	

Vedi sezione BASI a pag. 274
See BASE Section on page 274
Voir page 274, section BASES

Codici / Codes

SIR-E FA



90378 90377

Sirena elettronica multifunzione certificata EN54-3. Sviluppata con tecnologia multicanale, SIR-E FA permette di gestire due diversi livelli di allarme (pre-allarme, allarme) attivabili tramite contatti elettrici indipendenti. Multisuono: 13 suoni certificati EN54-3.

Tensione operativa

Utilizzo consentito solo con basi LT 12/24V.

Caratteristiche meccaniche

Polycarbonato autoestinguente ad alta resistenza agli impatti, adatto per utilizzo esterno grazie al grado di protezione IP65.

Caratteristiche acustiche

Buzzer elettromagnetico che produce:

- PRE-ALLARME, un potente suono elettronico di max. 100 dB (suono selezionabile via dip-switch tra 12 suoni certificati EN54-3)
- ALLARME, un potente suono elettronico di max. 100 dB (1 suono continuo certificato EN54-3: PFEER TOXIC GAS).

Certificazioni / Certifications



Numero CPR / Construction products regulation / Numero d'homologation CPR
EN54-3 | 1328-CPR-0479

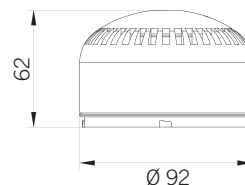

SIR-E FA



EN54-3 approved multifunctional electronic sounder. Developed with a multichannel technology, SIR-E FA allows two separate levels of alarm (pre-alarm, alarm) controllable via independent electric contacts. Multitone: 13 EN54-3 approved tones.

Voltages

Must be used with LT 12/24V base.

Mechanical features

Self-extinguishing PC body with high impact resistance, suitable for outdoor applications thanks to the IP65 protection grade.

Acoustic features

Electromagnetic buzzer producing:
- PRE-ALARM, a powerful up to 100 dB electronic tone (selectable via dip switch out of 12 EN54-3 approved tones)
- ALARM, a powerful up to 100 dB electronic tone (1 EN54-3 approved continuous tone: PFEER TOXIC GAS).



Sirène électronique multifonctionnelle certifiée selon la norme EN54-3. Développée avec une technologie multicanale, SIR-E FA permet d'avoir deux niveaux d'alarme (pré-alarme, alarme) réglables à l'aide de connexions électriques séparées. Multi-sons : 13 sons homologués selon EN54-3.

Tension d'utilisation

Utilisation autorisée seulement avec bases LT 12/24V.

Caractéristiques mécaniques

Polycarbonate autoextinguible, haute résistance aux chocs, adapté pour une utilisation à l'extérieur grâce au degré de protection IP65.

Caractéristiques acoustiques

Buzzer électromagnétique qui produit :
- PRE-ALARME, un puissant son électronique d'un maximum de 100 dB (le son peut être sélectionné à l'aide de dip-switch entre 12 sons homologués selon EN54-3)
- ALARME, un puissant son électronique d'un maximum de 100 dB (un son continu homologué selon EN54-3 : type PFEER TOXIC GAS).

SIR-E LED FA



SIR-E LED FA

100 dB max - EN54-3

Cupole / Domes / Dômes

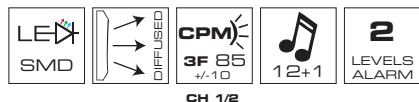

SIR-E LED FA

V DC	12 ÷ 24
mA	120 110
dB(A)1m	80 ÷ 100

Può essere installato con
Can be installed with
Peut être assemblé à

Basi / Bases



	EN54-3	EN54-3	EN54-3
	SHALLOW	DEEP	WALL
12/24V ACDC	✓	✓	✓
PNP 12/24V DC	✗	✗	✓
	FLUSH	DOUBLE	POLE
		EN54-3	

Vedi sezione BASI a pag. 274
See BASE Section on page 274
Voir page 274, section BASES

Codici / Codes

SIR-E LED FA



Sirena elettronica con luce a LED multifunzione certificata EN54-3. Sviluppata con tecnologia multicanale, SIR-E LED FA permette di gestire due diversi livelli di allarme (pre-allarme, allarme) attivabili tramite contatti elettrici indipendenti. Multisuono: 13 suoni certificati EN54-3 e luce con effetto stroboscopico.

Tensione operativa

Utilizzo consentito solo con basi LT 12/24V.

Caratteristiche meccaniche

Polycarbonato autoestinguente ad alta resistenza agli impatti, adatto per utilizzo esterno grazie al grado di protezione IP65.

Caratteristiche acustiche e luminose

Buzzer elettromagnetico. 4 LED Bright disposti a 360°.

Due livelli di allarme:

- PRE-ALLARME, un potente triplo flash (effetto strobo) combinato ad un potente suono elettronico di max. 100 dB (suono selezionabile via dip-switch tra 12 suoni certificati EN54-3)
- ALLARME, un potente triplo flash (effetto strobo) combinato ad un potente suono elettronico di max. 100 dB (1 suono continuo certificato EN54-3: PFEER TOXIC GAS).

Certificazioni / Certifications



Numero CPR / Construction products regulation / Numero d'homologation CPR
EN54-3 | 1328-CPR-0479

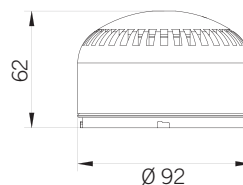

SIR-E LED FA



EN54-3 approved multifunctional electronic LED beacon sander. Developed with a multichannel technology, SIR-E LED FA allows two separate levels of alarm (pre-alarm, alarm) controllable via independent electric contacts. The device is multitone, 13 EN54-3 approved tones enriched by a strobe effect flashing light.

Voltages

Must be used with LT 12/24V base.

Mechanical features

Self-extinguishing PC body with high impact resistance, suitable for outdoor applications thanks to the IP65 protection grade.

Acoustic and optical features

Electromagnetic buzzer. 4 Bright LEDs over 360°.

Two levels of alarm:

- PRE-ALARM, a powerful up to 100 dB electronic tone (selectable via dip switch out of 12 EN54-3 approved tones) sustained by a strobe effect flashing light
- ALARM, a powerful up to 100 dB electronic tone (1 EN54-3 approved continuous tone: PFEER TOXIC GAS) sustained by a strobe effect flashing light.



Dispositif acoustique/lumineux à LED multifonctionnel certifié selon la norme EN54-3. Développé avec une technologie multicanale, SIR-E LED FA permet d'avoir deux niveaux d'alarme (pré-alarme, alarme) réglables à l'aide de connexions électriques séparées. Le produit est multi-sons, il dispose de 13 sons homologués selon EN54-3 et se complète avec une lumière à effet stroboscopique.

Tension d'utilisation

Utilisation autorisée seulement avec bases LT 12/24V.

Caractéristiques mécaniques

Polycarbonate autoextinguible, haute résistance aux chocs, adapté pour une utilisation à l'extérieur grâce au degré de protection IP65.

Caractéristiques acoustiques et optiques

Buzzer électromagnétique. 4 LED haute luminosité sur 360°.

Deux niveaux d'alarme :

- PRE-ALARME, un triple-flash puissant (effet stroboscopique) combiné avec un puissant son électronique d'un maximum de 100 dB (le son peut être sélectionné à l'aide de dip-switch entre 12 sons homologués selon EN54-3)
- ALARME, un triple-flash puissant (effet stroboscopique) combiné avec un puissant son électronique d'un maximum de 100 dB (un son continu homologué selon EN54-3 : type PFEER TOXIC GAS).

SLR FA



SLR FA

EN54-23*

*Certificazione EN54-23 per il solo modello con luce bianca

*EN54-23 approval white color version only

*Homologation EN54-23 seulement pour la version avec lumière blanche (codice / part no. / code 90125)

Cupole / Domes / Dômes



SLR FA

V DC	24
mA	300

Può essere installato con
Can be installed with
Peut être assemblé à

Basi / Bases



EN54-23

Vedi sezione BASI a pag. 274
See BASE Section on page 274
Voir page 274, section BASES

Codici / Codes

SLR FA



Dispositivo a LED certificato EN54-23* (24V DC) ad alte performance ottiche. SLR FA dispone di un effetto luminoso monolampo.

Tensione operativa

Utilizzo consentito solo con basi LT 12/24V.

Caratteristiche meccaniche

Polycarbonato autoestinguente ad alta resistenza agli impatti, adatto per utilizzo esterno grazie al grado di protezione IP66.

Caratteristiche luminose

2x LED SuperBright ad alta luminosità, con lente di Fresnel interna, producono luce lampeggiante (flash singolo 1F).

Certificazioni / Certifications



Numero CPR / Construction products regulation / Numero d'homologation CPR
EN54-23 | 1328-CPR-0423

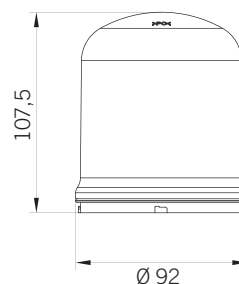

SLR FA



EN54-23* approved LED beacon (24V DC) with excellent optical performance. SLR FA allows a flashing effect (single flash).

Voltages

Must be used with LT 12/24V base.

Mechanical features

Self-extinguishing PC body with high impact resistance, suitable for outdoor applications thanks to the IP66 protection grade.

Optical features

2x SuperBright LEDs, with inner Fresnel lens, allow a flashing light (single flash 1F).



Dispositif à LED certifié selon la norme EN54-23* (24V DC) à haute performance optique. SLR FA dispose d'un effet lumineux simple éclat.

Tension d'utilisation

Utilisation autorisée seulement avec bases LT 12/24V.

Caractéristiques mécaniques

Polycarbonate autoextinguible, haute résistance aux chocs, adapté pour une utilisation à l'extérieur grâce au degré de protection IP66.

Caractéristiques optiques

2x LED SuperBright avec lentille de Fresnel à l'intérieur, produisent une lumière clignotante (simple éclat 1F).

XLF FA



XLF FA

EN54-23*

*Certificazione EN54-23 per il solo modello con luce bianca

*EN54-23 approval white color version only

*Homologation EN54-23 seulement pour la version avec lumière blanche (codice / part no. / code 90127)

Cupole / Domes / Dômes



XLF FA

V DC	24
mA	150

Può essere installato con
Can be installed with
Peut être assemblé à

Basi / Bases



	EN54-23		EN54-23		EN54-23	
	SHALLOW	DEEP	SHALLOW	DEEP	WALL	WALL
12/24V ACDC	✓	✓	✓	✓	✓	✓
PNP 12/24V DC	✗	✗	✓	✓	✓	✓
	FLUSH		DOUBLE		POLE	

Vedi sezione BASI a pag. 274
See BASE Section on page 274
Voir page 274, section BASES

Codici / Codes

XLF FA



Dispositivo a LED certificato EN54-23* (24V DC) ad alte performance ottiche. XLF FA dispone di un effetto luminoso monolampo. Disponibile con lente Directional.

Tensione operativa

Utilizzo consentito solo con basi LT 12/24V.

Caratteristiche meccaniche

Polycarbonato autoestinguente ad alta resistenza agli impatti, adatto per utilizzo esterno grazie al grado di protezione IP66.

Caratteristiche luminose

1x LED SuperBright ad alta luminosità, luce lampeggiante (flash singolo 1F).



Lente di Fresnel per la segnalazione a distanza
Fresnel lens for long-distance signalization
Lentille de Fresnel pour signalisation à longue distance

Certificazioni / Certifications



Numero CPR / Construction products regulation / Numero d'homologation CPR
EN54-23 | 1328-CPR-0421

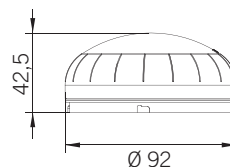

XLF FA



EN54-23* approved LED beacon (24V DC) with excellent optical performance. XLF FA allows a flashing effect (single flash). Available with Directional lens.

Voltages

Must be used with LT 12/24V base.

Mechanical features

Self-extinguishing PC body with high impact resistance, suitable for outdoor applications thanks to the IP66 protection grade.

Optical features

1x SuperBright LED allows a flashing light (single flash 1F).



Dispositif à LED certifié selon la norme EN54-23* (24V DC) à haute performance optique. XLF FA dispose d'un effet lumineux simple éclat. Disponible avec lentille Directional.

Tension d'utilisation

Utilisation autorisée seulement avec bases LT 12/24V.

Caractéristiques mécaniques

Polycarbonate autoextinguible, haute résistance aux chocs, adapté pour une utilisation à l'extérieur grâce au degré de protection IP66.

Caractéristiques optiques

1x LED SuperBright haute luminosité produit une lumière clignotante (simple éclat 1F).

BASI / BASES



SHALLOW

Codici / Codes

SHALLOW

LT 12/24V ACDC



90343 90344

SHALLOW

Base bassa ideale per il montaggio superficiale dove il cablaggio avviene dalla base del dispositivo e dove è richiesta una maggiore compattezza dello stesso.



Base designed for flat surface mounting where cabling occurs from the bottom of the device and where a compact design is required.



Base basse idéale pour le montage à plat avec câblage par le dessous de la base et offrant un dispositif d'un très faible encombrement.

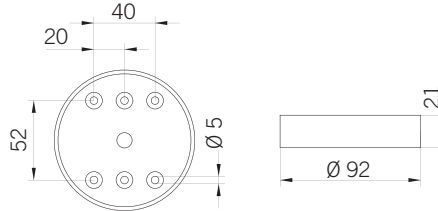

DEEP

Codici / Codes

DEEP

LT 12/24V ACDC
LT PNP 12/24V DC

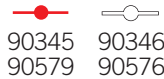

90345 90346
90579 90576

DEEP

Base progettata per il montaggio superficiale ad ingresso laterale attraverso uno o due pressacavi M20. Questa è la soluzione ideale quando il cablaggio dalla base del dispositivo non è effettuabile o quando è richiesta un'installazione in serie.

Disponibile anche con collegamenti PNP (positivo-negativo-positivo) per uso con PLC in modalità sourcing.



Base designed for flat surface mounting in conjunction with the use of cable glands. This base allows up to two M20 cable glands making this solution ideal for series mounting. Also available with PNP (positive-negative-positive) connections for use with PLC in sourcing mode.



Base idéale pour le montage à plat avec entrée de câblage latérale par un ou deux presse-étoupes M20. C'est la solution idéale quand le câblage par le dessous de la base du dispositif n'est pas possible ou quand une installation en série est nécessaire.

Disponibile aussi avec connexions PNP (positif-négatif-positif) pour utilisation avec PLC en mode "sourcing".

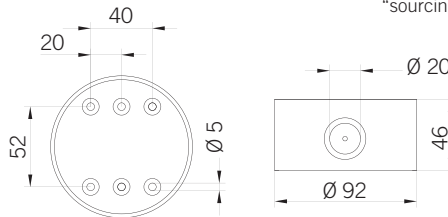

2 x M20 (forniti / supplied / fournis)



WALL

Codici / Codes

WALL

LT 12/24V ACDC
LT PNP 12/24V DC

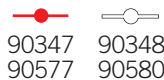

90347 90348
90577 90580

WALL

Base per montaggio a parete, è la scelta ideale per installazioni laterali. Offre la possibilità di utilizzare fino a due pressacavi M20 offrendo la possibilità di installare il prodotto sia in serie che in punti non cablabili dal retro del prodotto. Disponibile anche con collegamenti PNP (positivo-negativo-positivo) per uso con PLC in modalità sourcing.



Base designed for lateral/wall mounting. Allows installing up to two M20 pressure glands making this product suitable also when it's not possible to wire the base of the signaling device. Also available with PNP (positive-negative-positive) connections for use with PLC in sourcing mode.



Base pour montage en applique. C'est le choix idéal pour des installations en parois. Elle offre la possibilité d'utiliser jusqu'à deux presse-étoupes M20, permettant de câbler le produit en série, avec entrée de câbles par le dessous de la base mais avec aussi deux entrées de câbles par l'arrière de la face d'appui. Disponible avec connexions PNP (positif-négatif-positif) pour utilisation avec PLC en mode "sourcing".

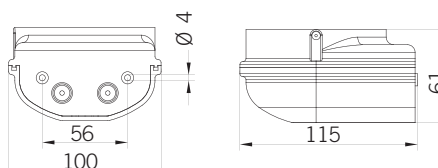

BASI / BASES



Codici / Codes

DOUBLE

DOUBLE

LT 12/24V ACDC
LT PNP 12/24V DC

90373 90374
90578 90581



Base designed for lateral/wall mounting, it can mount up to two modules creating unique combinations between visual and acoustic devices whilst the multifunctionality of each module is guaranteed. Also available with PNP (positive-negative-positive) connections for use with PLC in sourcing mode.



Base pour montage en applique. Elle est l'idéale pour installer jusqu'à deux dispositifs de la gamme. Parfaite pour créer des combinaisons uniques de modules acoustiques et lumineux, assurant ainsi la multifonctionnalité de ceux-ci. Disponible aussi avec connexions PNP (positif-négatif-positif) pour utilisation avec PLC en mode "sourcing".

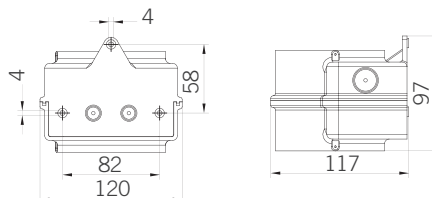

2 x M20 (predisposta / ready / prédisposée)



Codici / Codes

FLUSH

FLUSH

LT 12/24V ACDC

90349 90375



Base designed for flushmounted applications. It guarantees a simple and discrete installation of the device allowing a low visual impact when aesthetic is required like for example in Civil or Commercial installations.

Not UL approved.



Base à encastrer idéale pour le montage en faux-plafond. Elle assure une installation simple et discrète du dispositif adaptée à toutes les situations où il est nécessaire de respecter des normes esthétiques, comme par exemple dans des applications grand public et commerciales.

Non certifiée UL.

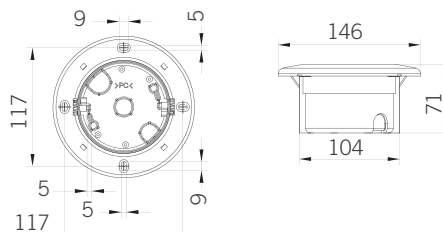

Codici / Codes

POLE

POLE

LT 12/24V ACDC
LT PNP 12/24V DC

90619 90616
90628 90626

1" NPT-F ADATTATORE / ADAPTER / ADAPTATEUR 90555
½" NPT-F ADATTATORE / ADAPTER / ADAPTATEUR 90556



Base designed for pole mounted installations. It allows to install any dome on a 1" ½ NPT threaded pole or, via the use of adaptors, on a 1" or ½" NPT threaded pole.

Also available with PNP (positive-negative-positive) connections for use with PLC in sourcing mode. UL certification with supplied safety collar.



Conçue pour installer n'importe quel dôme sur mât fileté de 1"½ NPT ou, par adaptateurs, sur mât fileté de 1" ou ½" NPT. Disponible avec connexions PNP (positif-négatif-positif) pour utilisation avec PLC en mode "sourcing". Certification UL avec le collier de sécurité fourni.

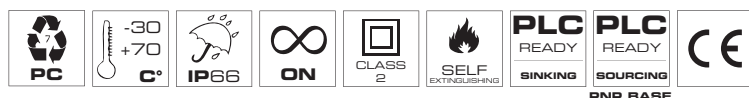
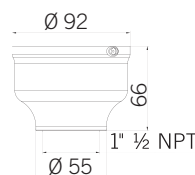

GAMMA ATEX

Sirena, leader mondiale nella progettazione e produzione di dispositivi per la segnalazione acustica e luminosa, presenta la **gamma antideflagrante**.

La gamma, rivolta principalmente ai settori chimici e petroliferi, è stata concepita per soddisfare le richieste più esigenti e per garantire il massimo della qualità e della sicurezza rifacendosi a standard di progettazione, produzione e certificazione elevatissimi.

La **gamma ATEX** permette di portare il know-how e l'esperienza maturata nei vari settori industriali, alla portata di tutta l'utenza antideflagrante.

La gamma antideflagrante Sirena è stata certificata dal CESI, Organismo Notificato dal Governo Italiano ai sensi della Direttiva ATEX 2014/34/UE per la certificazione di apparecchiature elettriche destinate a zone a rischio di esplosione.

Tutta la gamma **EXPRO** Sirena è stata certificata nel Gruppo II, ossia in tutte quelle situazioni che prevedono installazioni in zone ad alto rischio, miniere escluse.

La Categoria assegnata è la 2, il che consente di utilizzare la gamma ATEX nelle Zone 1, 2, 21 e 22 quindi sia in presenza di gas (G: gas) che in presenza di polveri (D: dust).

La certificazione è conforme alla norma EN/IEC 60079 che abilita all'utilizzo del marchio Ex.

Il Modo di protezione dei dispositivi è costituito da una custodia a prova esplosione e a sicurezza aumentata che garantisce lo status "de" (in presenza di atmosfera potenzialmente esplosiva con GAS) e "tb" (in presenza di atmosfera potenzialmente esplosiva con polveri).

Il Gruppo di esplosione approvato per la gamma Sirena, particolarmente importante per l'utilizzo in atmosfera esplosiva dovuta a gas, è il IIC, il più pericoloso che include anche Idrogeno e Acetilene. Per quanto riguarda il gruppo di esplosione, relativo ad atmosfera esplosiva per la presenza di polveri, i dispositivi Sirena sono certificati per il IIC, ossia sono idonei ad essere installati in presenza di qualsiasi polvere (anche polveri conduttive).

Alla gamma ATEX è stata assegnata la Classe di Temperatura T6, la più difficile da ottenere, poiché garantisce una temperatura massima sulla superficie della custodia di soli 85°C.



ATEX RANGE

Sirena, worldwide leader in the production of acoustic and luminous signaling devices, presents the **explosion-proof range**.

This range is intended primarily for those particular sectors such as refineries and chemical industries, offering high quality and safety standards.

The **ATEX range** has been developed applying Sirena's know-how and experience for the professional needs in explosion-proof field.

Sirena's explosion proof range of products has been approved by CESI, Notified Body of the Italian Government, according to ATEX Directive 2014/34/EU for the certification of explosion proof devices intended for use in potentially explosive atmospheres.

Sirena's entire **EXPRO** range has been certified in Group II, that foresees installation in all high-risk areas, excluding mines.

EXPRO range of products has been appointed Category 2, that allows use in Zone 1, 2, 21 and 22, in both the presence of gas (G) as well as dust (D).

Certification is according to EN/IEC 60079 directive that allows the use of the Ex identifying mark.

Type of Protection of the devices is provided by an explosion proof housing with increased safety, guaranteeing "de" status (in presence of GAS potentially explosive atmospheres) and "tb" (in presence of DUST potentially explosive atmospheres).

The proven explosion Group, particularly important for use in explosive atmospheres due to gas, is IIC, the most dangerous, that includes Hydrogen and Ethyl Acetate. The proven explosion Group for use in explosive atmospheres due to dust, is IIIC, it means that **EXPRO** products can be used in presence of any dust (also conductive dust).

The whole range is certified for use in class T6 temperature that guarantees a maximum surface temperature of the housing of just 85°C, that is the most difficult to obtain.



GAMME ATEX

Sirena, leader mondial dans le développement et la fabrication de dispositifs de signalisation acoustique et lumineux, présente la **gamme antidéflagrante**.

La gamme convient principalement au secteur de la chimie et au secteur pétrolier, elle a été conçue pour répondre aux demandes les plus exigeantes en matière de qualité et de sécurité.

Notre savoir-faire et notre expérience dans les différents secteurs de l'industrie nous permet de proposer une **gamme** adaptée pour le **secteur antidéflagrant**.

La gamme antidéflagrante **EXPRO** de Sirena a été certifiée par le CESI, l'Organisme Notifié selon la Directive ATEX 2014/34/UE pour la certification des appareils et des systèmes antidéflagrants qui peuvent être employés dans des zones à risque d'explosion.

Toute la gamme **EXPRO** de Sirena a été certifiée pour l'installation dans le Groupe II, c'est-à-dire dans des lieux soumis aux atmosphères explosives autres que les mines grisouteuses.

Elle a été classée dans la catégorie 2 qui permet l'installation de la gamme ATEX dans les Zones 1, 2, 21 et 22 soit en présence de gaz (G : gaz) soit de poussières (D : dust).

La certification est conforme à la norme EN/IEC 60079 qui permet l'utilisation du code Ex.

Le mode de protection des dispositifs est une enveloppe antidéflagrante à sécurité augmentée qui garanti le statut « de » (en présence d'une atmosphère explosible type gaz) et « tb » (en présence d'une atmosphère explosible type poussière).

Le Groupe d'explosion certifié pour toute la gamme Sirena est le IIC (pour atmosphères explosibles type gaz), le plus dangereux, incluant Hydrogène et Acétylène. Pour les atmosphères explosives type poussière, les dispositifs Sirena sont certifiés pour le IIIC, c'est-à-dire qu'ils sont appropriés pour l'installation en présence de tout type de poussières (même poussières conductrices).

A notre gamme ATEX a été attribuée la Classe de Température T6, la plus difficile à obtenir, car elle garantit une température de surface maximale de l'enveloppe de 85°C seulement.



BOX SEO ETH 20 MD/4U



BOX SEO ETH 20 MD/4U-AA
BOX SEO ETH 20 MD/4U-AA PCS

ETH 20



BOX



ETH 20 MD

V ACDC	12 ÷ 24
A	0,8
dB(A)1m	110

Modo di protezione / Methods of Protection Mode de protection



ETH 20 MD
II 2GD
Ex d IIC T3 Gb
Ex tb IIIC T150°C Db IP6X

Codici / Codes

BOX SEO ETH 20 MD/4U-AA / PCS

BOX SEO ETH 20 MD/4U-AA 50309
BOX SEO ETH 20 MD/4U-AA PCS 50310

RICAMBI / SPARE PARTS / RECHANGES ETH 20 MD

12/24V ACDC 57998

Tra i vari componenti, SIRENA dispone anche di sistemi dotati di TROMBA ATEX abbinata ai BOX SEV, per la gestione dei vari segnali di allarme acustico in zone pericolose. Il BOX comandi andrà posizionato in zona sicura, collegando il diffusore acustico ATEX entro una distanza di 10 m.

TROMBA ATEX ETH

Sirena elettronica, costruita secondo i più alti standard qualitativi, garantisce un livello acustico di alta gamma e la possibilità di scegliere tra tonalità differenti. Sirena elettronica antideflagrante per impiego in aree del Gruppo II con atmosfera esplosiva per zona 1 e 2.

Temperatura massima superficiale

T3

Certificazioni / Certifications



0080



ISSEP 11 ATEX 040 X

BOX SEO ETH 20 MD/4U-AA | BOX SEO ETH 20 MD/4U-AA PCS

Struttura apparecchio

- FRONTALE FINISTRATO con luci di segnalazione a LED

Funzione

Di default il prodotto dispone di circuito elettronico per la gestione di 4 diversi allarmi:

- LIVELLO 1 | ALLERTAMENTO
- LIVELLO 2 | EVACUAZIONE
- LIVELLO 3 | CESSATO ALLARME
- LIVELLO 4 | INCENDIO

Il livello acustico, per via del filtro sinterizzato (posto all'interno del diffusore), si riduce a 110 dB (A) 1m sull'asse della tromba. N.B. Il collegamento della tromba esponenziale deve essere effettuato utilizzando i contatti di uscita ausiliari NA. La scelta del suono deve essere effettuata sulla tromba tramite dip-switch.

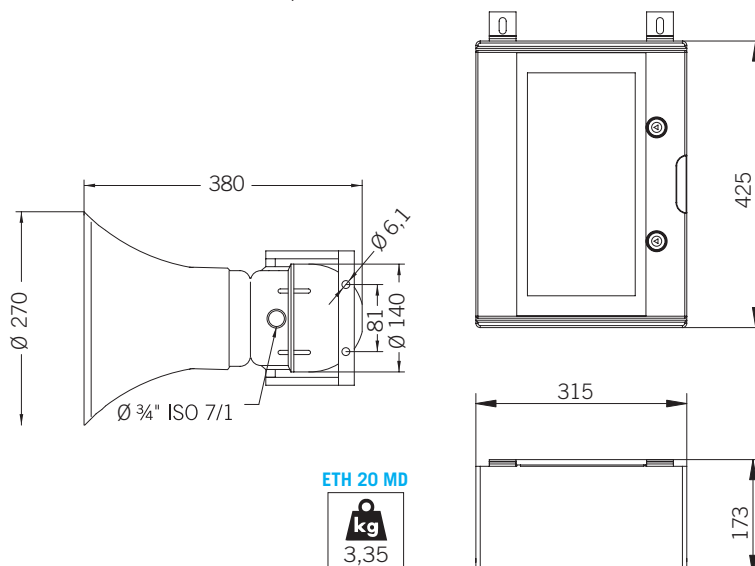

Among the different components, SIRENA proposes systems of ATEX sound diffuser combined with SEV BOX for acoustic alarm signaling in dangerous zones. The command BOX must be located in a safe area and the horn within 10 m.

ETH ATEX HORN

Electronic siren allowing high quality sound output and the possibility to select different sounds. Explosion-proof electronic siren of Group II for use in areas with explosive atmosphere Zones 1 and 2.

Temperature class

T3

BOX SEO ETH 20 MD/4U BOX SEO ETH 20 MD/4U AA PCS

Device structure

- Transparent FRONT with LED light

Function

By default the product benefits from an electronic circuit allowing 4 alarm levels:

- LEVEL 1 | WARNING
- LEVEL 2 | EVACUATION
- LEVEL 3 | ALL CLEAR
- LEVEL 4 | FIRE ALARM

The sintered filter (in the diffuser) reduces the sound output to 110 dB(A)1m on the horn axis. Note: The exponential horn connection must be carried out using the auxiliary NO contacts. Sound selection through the DIP-SWITCH of the horn.



Sirena propose un système sonore : la sirène ATEX couplée au BOX SEV, adapté aux environnements dangereux. Le boîtier de commande sera placé dans une zone sûre et connecté au diffuseur acoustique éloigné d'une distance maximale de 10 mètres.

SIRENE ATEX ETH

La sirène électronique a été développée selon des standards de haute qualité, elle garantit un niveau sonore de hautes performances et offre la possibilité de choisir plusieurs tonalités. Sirène électronique antideflagrante du Groupe II, pour une utilisation en atmosphère explosive zones 1 et 2.

Classe de température

T3

BOX SEO ETH 20 MD/4U BOX SEO ETH 20 MD/4U AA PCS

Structure de l'appareil

- HUBLOT FRONTAL avec signalisation LED

Fonction

Par défaut le produit dispose d'un circuit électronique permettant la gestion de signaux d'alarmes : NIVEAU 1 | ALLERTE • NIVEAU 2 | EVACUATION NIV. 3 | FIN D'ALLARME • NIV. 4 | INCENDIE La puissance sonore en raison du filtre intégré dans le diffuseur se réduit à 110 dB(A)1m.

NB : Le câblage du diffuseur acoustique doit être effectué en utilisant les contacts auxiliaires de sortie NO. Le choix du son se fait par le micro-interrupteur du diffuseur.

EX 070 FLR S EX 070 SLR S



EX 070 FLR S

EX 070 SLR S

Cupole / Domes / Dômes

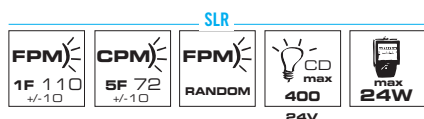
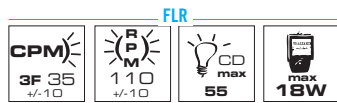

EX 070 FLR S

V ACDC	12 ÷ 24	40 ÷ 80	-
V AC	-	-	120 ÷ 240
mA	510 360	300 110	100 70

EX 070 SLR S

V ACDC	12 ÷ 24	40 ÷ 80	-
V AC	-	-	120 ÷ 240
mA	450 700	800 250	150 60

Modo di protezione / Methods of Protection / Mode de protection

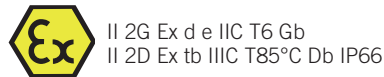

Codici / Codes

EX 070 FLR S

12/24V ACDC	97212	97213
40/80V ACDC	97242	97243
120/240V AC	97222	97223
12/24V ACDC allCLEAR	-	97230

EX 070 SLR S

12/24V ACDC	95002	95003
40/80V ACDC	97252	97253
120/240V AC	95012	95013

* Specificare la funzione luminosa desiderata al momento dell'ordine.
* Please specify the desired light effect when ordering.
* Spécifier l'effet lumineux souhaité lors de la commande.

Luci a LED integrati antideflagranti di medie dimensioni, EX 070 FLR S e EX 070 SLR S sono dispositivi multifunzione che permettono 3 funzioni luminose* (EX 070 FLR S: luce fissa, lampeggiante, rotante; EX 070 SLR S: luce lampeggiante, stroboscopica e random). Queste luci antideflagranti del Gruppo II possono essere installate in aree con atmosfera esplosiva zona 1, 2, 21 e 22.

* Specificare la funzione luminosa desiderata al momento dell'ordine.

Tensione operativa

12/24V ACDC, 40/80V ACDC, 120/240V AC +/-10%

Classe di temperatura

T6

Caratteristiche meccaniche

Corpo in lega di alluminio esente da rame. Cupola esterna in vetro borosilicato, cupola interna in policarbonato. Dotate di base piana, il fissaggio avviene con viteria standard non fornita.

Caratteristiche luminose

EX 070 FLR S: 24x LED Bright, in configurazione 6x4, producono tre effetti luminosi: luce fissa, lampeggiante (triplo flash effetto strobo), rotante (effetto rotante che simula perfettamente le luci rotanti tradizionali pur non avendo componenti mobili, permettendo quindi di accrescere enormemente il ciclo di vita del prodotto).

Disponibile con 2 tipi di lente: **allCOLOR** (lente colorata con fonte luminosa colorata) e **allCLEAR** (lente neutra con fonte luminosa colorata), vedi pagina 103.

EX 070 SLR S: 2x LED SuperBright, con lente di Fresnel interna, producono tre effetti luminosi: luce lampeggiante (flash singolo 1F), effetto stroboscopico 5F, luce random (effetto unico nel suo genere con lampeggio casuale che consente di aumentare la capacità del dispositivo di attirare l'attenzione).

Certificazioni / Certifications



0477



CESI 05 ATEX 043

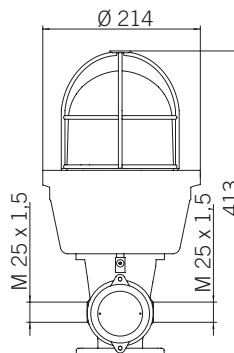

EX 070 FLR S
EX 070 SLR S



Medium range explosion-proof integrated LED beacons, EX 070 FLR S and EX 070 SLR S are multifunctional devices allowing 3 different light options* (EX 070 FLR S: steady, flashing, rotating; EX 070 SLR S: flashing, strobe, random). These explosion-proof beacons of Group II can be used in areas with explosive atmosphere Zones 1, 2, 21 and 22.

* Please specify the desired light effect when ordering.

Voltagges

12/24V ACDC, 40/80V ACDC, 120/240V AC +/-10%

Temperature class

T6

Mechanical features

Housing in copper-free aluminum alloy. Borosilicate glass external dome, polycarbonate internal dome. Provided with flat base. Screw mounting (screws not included).

Optical features

EX 070 FLR S: 24x Bright LEDs, in a 6x4 configuration, allow three luminous effects: steady light, flashing light (a triple-flash strobe effect), rotating light (a rotating effect perfectly simulating the traditional rotating beacons yet without moving parts, hence enormously enhancing product life time). Available with 2 different lens types, **allCOLOR** (colored lens with colored light source) and **allCLEAR** (clear lens with colored light source), see page 103.

EX 070 SLR S: 2x SuperBright LEDs, with inner Fresnel lens, allow three luminous effects: flashing light (single flash 1F), 5F strobe effect, random light (a unique random effect consisting in an uneven flashing pattern, augmenting the ability of catching attention).



Feux LED antidéflagrants de dimensions moyennes, EX 070 FLR S et EX 070 SLR S sont dispositifs multifonctionnels qui permettent 3 effets lumineux* (EX 070 FLR S : lumière fixe, clignotante, tournante; EX 070 SLR S : lumière clignotante, effet stroboscopique, effet random). Ces feux antidéflagrants du Groupe II peut être utilisé en atmosphère explosive, zone 1, 2, 21 et 22.

* Spécifier l'effet lumineux souhaité lors de la commande.

Tension d'utilisation

12/24V ACDC, 40/80V ACDC, 120/240V AC +/-10%

Classe de température

T6

Caractéristiques mécaniques

Corps en alliage d'aluminium sans cuivre. Dôme externe en verre borosilicate, dôme interne en polycarbonate. Equipé avec base plate, fixation par vis standards non fournies.

Caractéristiques optiques

EX 070 FLR S : 24x LED Bright, en configuration 6x4, qui produisent trois effets lumineux : lumière fixe, lumière clignotante (triple-flash, effet stroboscopique) effet tournant, qui simule parfaitement les feux tournants traditionnels sans avoir de composants mobiles, permettant ainsi d'augmenter considérablement la durée de vie du produit.

Disponible avec deux différents types de lentilles : **allCOLOR** (lentille colorée et source lumineuse colorée) et **allCLEAR** (lentille incolore transparente avec source lumineuse colorée), voir page 103.

EX 070 SLR S : 2x LED SuperBright avec lentille de Fresnel à l'intérieur, produisent trois effets lumineux: lumière clignotante (simple éclat 1F), effet stroboscopique 5F, effet random (consistant en un clignotement aléatoire, qui permet au dispositif d'augmenter la capacité d'attirer l'attention).

LUCI AUSILIARIE AUXILIARY BEACONS FEUX AUXILIAIRES



FAROLAMP X

Cupole / Domes / Dômes

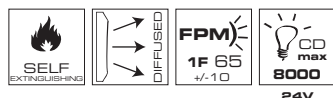
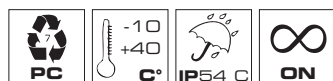

FAROLAMP X

V ACDC	12 ÷ 24
mA	900 450

Codici / Codes

FAROLAMP X

84970 85044 85370

Segnalatore luminoso XENON progettato per la segnalazione addizionale qualora il rumore di fondo sia particolarmente elevato.

Il prodotto può essere collegato al contatto ausiliario disponibile in tutte le sirene della linea **ESCAPE**. L'alimentazione è fornita direttamente dalle batterie della sirena a cui è collegato e l'attivazione è contestuale al suono scelto in base al livello di allarme:

LIVELLO 1 | ALLERTAMENTO | AMBRA

LIVELLO 2 | EVACUAZIONE | ROSSO

LIVELLO 3 | CESSATO ALLARME | VERDE

Le luci dispongono anche di scritte adesive per identificare i rispettivi livelli.

Il suo utilizzo in abbinamento alle sirene è consigliabile per la realizzazione di un impianto ottimale, mentre diventa indispensabile in presenza di persone non udenti o che utilizzano presidi acustici.

Tensione operativa

12/24V ACDC

Caratteristiche meccaniche

Base in acciaio ad alta resistenza agli impatti e fissaggio tramite viteria standard non fornita. Cupola in policarbonato autoestinguente.

Caratteristiche luminose

1 canale disponibile (1F lampeggiante continuo), ideale per una segnalazione frontale e bidirezionale.

La lampada a scarica di Xenon da 6J e la cupola appositamente studiata garantiscono un potente flash singolo (1F).

Certificazioni / Certifications

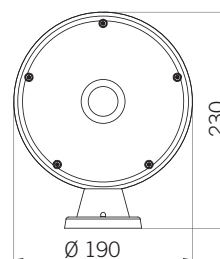
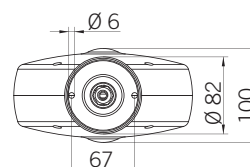

FAROLAMP X



XENON flashing beacon developed for a supplementary signaling when the ambient background noise particularly high is.

The product can be connected to the auxiliary contact available in all **ESCAPE** sirens. Power supply directly from the siren's batteries and activation according to alarm level:

LEVEL 1 | WARNING | ORANGE

LEVEL 2 | EVACUATION | RED

LEVEL 3 | ALL CLEAR | GREEN

Beacons have stickers identifying the different alarm levels.

The use of this beacon is recommended for an optimal system configuration, while is essential in presence of deaf persons or persons using hearing aids.

Voltages

12/24V ACDC

Mechanical features

High impact resistance steel base. Screw mounting, screws not included. Self-extinguishing polycarbonate dome.

Optical features

1 available channel (1F flashing), ideal for frontal and bidirectional signaling. 6J Xenon discharge tube enhanced by the dome-shaped Fresnel lens provide a strong single flash (1F).



Feu au XENON, permet l'ajout d'un signal lumineux complémentaire lorsque le bruit ambiant est particulièrement élevé.

Le dispositif peut être connecté au contact auxiliaire présent sur chaque sirène de la gamme **ESCAPE**. L'alimentation est fournie directement depuis la batterie de la sirène à laquelle il est connecté, son activation dépend du signal d'alarme en cours :

NIVEAU 1 | ALERTE | ORANGE

NIVEAU 2 | EVACUATION | ROUGE

NIVEAU 3 | FIN D'ALARME | VERT

Des autocollants sont présents sur les feux pour distinguer les différents niveaux.

Leur utilisation couplée aux sirènes est recommandée pour une installation optimale, et devient indispensable en présence d'opérateurs malentendants ou qui utilisent des protections auditives.

Tension d'utilisation

12/24V ACDC

Caractéristiques mécaniques

Base en acier à haute résistance aux chocs et fixation par vis standards non fournies. Dôme en polycarbonate autoextinguible.

Caractéristiques optiques

1 canal disponible (1F clignotant) idéal pour une signalisation frontale et bidirectionnelle. Tube à décharge au Xénon 6J et dôme spécialement conçu pour garantir un puissant flash simple éclat (1F).

LUCI FA FA BEACONS FEUX FA



FAROLAMP FA

Cupole / Domes / Dômes

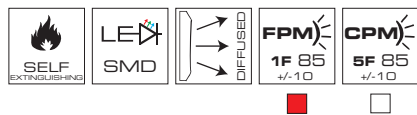

FAROLAMP FA

V DC	24
mA	300

Codici / Codes

FAROLAMP FA



Segnalatore luminoso LED certificato EN54-23 ad alte performance ottiche, FAROLAMP FA è disponibile con effetto stroboscopico oppure con luce lampeggiante. FAROLAMP FA è la scelta ideale per un dispositivo certificato di alta gamma.

Tensione operativa

24V DC

Caratteristiche meccaniche

Cupola in policarbonato autoestinguento ad alta resistenza agli impatti

Caratteristiche luminose

2x LED SuperBright ad alta luminosità. La cupola a lente di Fresnel consente di magnificare il fascio luminoso.

LUCE STROBOSCOPICA - COLORE BIANCO

Effetto stroboscopico (5x), la soluzione ideale per tutte quelle applicazioni in cui è fondamentale attirare l'attenzione

LUCE LAMPEGGIANTE - COLORE ROSSO

Monolampo intenso e ricco (1F)

Certificazioni / Certifications



Numero CPR / Construction products regulation / Numero d'homologation CPR
EN54-23 | 1328-CPR-0422

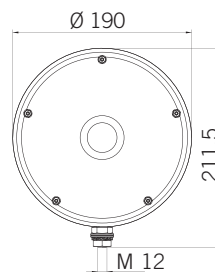

FAROLAMP FA



EN54-23 LED beacon with high optical performance, FAROLAMP FA is available with stroboscopic effect or flashing light. FAROLAMP FA is the ideal choice for a high-end approved beacon.

Voltages

24V DC

Mechanical features

High impact resistance self-extinguishing polycarbonate dome

Optical features

2x SuperBright LEDs. The dome-shaped Fresnel lens intensifies the light beam.

STROBE EFFECT - WHITE COLOR

Strobe effect (5x), ideal for alerting staff

FLASHING LIGHT - RED COLOR

An intense and rich single flash (1F)



Feu LED certifié EN54-23 à hautes performances optique, FAROLAMP FA est disponible avec effet stroboscopique et lumière clignotante. FAROLAMP FA est le choix idéal pour un dispositif de haute qualité.

Tension d'utilisation

24V DC

Caractéristiques mécaniques

Dôme en polycarbonate autoextinguible à haute résistance aux chocs.

Caractéristiques optiques

2x LED SuperLumineuse à haute luminosité. La lentille de Fresnel amplifie le faisceau lumineux.

LUMIERE STROBOSCOPIQUE - COULEUR BLANC

Effet stroboscopique (5x), le choix idéal pour un signal attirant fortement l'attention.

LUMIERE CLIGNOTANTE - COULEUR ROUGE

Simple flash intense et riche (1F)



RIFERIMENTI LEGISLATIVI E NORMATIVE

Segnaliamo di seguito alcuni riferimenti importanti per la corretta scelta dei dispositivi di segnalazione acustica e luminosa per gli **impianti di EVACUAZIONE**.

Il **D. Leg.vo 626/94** ha introdotto il concetto di sicurezza negli ambienti di lavoro, rendendo operative in Italia una serie di normative europee in tema di sicurezza, che ciascun Paese dell'Unione ha poi tradotto nella propria legislazione, con proprie normative interne.

Già il **D. Leg.vo 493/96 (Allegati VI e VII)** stabiliva ed attuava più in concreto le caratteristiche che la segnalazione acustica deve possedere.

PRESCRIZIONI PER I SEGNALI ACUSTICI E OTTICI

Un segnale acustico deve:

- avere un livello sonoro chiaramente udibile e nettamente superiore ai rumori di fondo
- essere facilmente riconoscibile e
- nettamente distinguibile da altri segnali acustici e/o rumori di fondo.

Al segnale acustico è opportuno affiancare dei dispositivi luminosi di colore rosso per indicare l'evacuazione. Dal 9 Aprile 2008 il nuovo **TESTO UNICO D. Leg.vo n. 81 del 9 APRILE 2008** attuativo della legge Delega n. 123 del 3 Agosto 2007, ha sostituito tali Decreti, riprendendo ed aggiornando le norme e le procedure.

Le procedure di prevenzione e protezione dei rischi negli ambienti di lavoro, diventano il nucleo fondamentale su cui sviluppare la nuova cultura della sicurezza. Inoltre il **TESTO UNICO** ha fornito in dettaglio **criteri specifici e caratteristiche delle segnalazioni acustiche e luminose** da adottare negli impianti di EVACUAZIONE.

Nell'ambito del nuovo **TESTO UNICO**, le **caratteristiche dei segnali sono riportate negli allegati XXIX e XXX**:

ALLEGATO XXIX: PRESCRIZIONE PER I SEGNALI LUMINOSI

- La luce emessa da un segnale deve produrre un contrasto luminoso adeguato al suo ambiente senza provocare abbagliamento o cattiva visibilità;
- La superficie luminosa può essere di colore uniforme;
- Se il dispositivo emette un **segnale continuo** ed uno **intermittente**, il segnale intermittente sarà impiegato per indicare un livello più **elevato di pericolo**;
- Se al posto o ad integrazione di un segnale acustico si utilizza un segnale luminoso **intermittente**, il codice del segnale dovrà essere identico;
- Un dispositivo che emette un segnale luminoso utilizzabile in caso di pericolo grave, andrà munito di comandi speciali o lampada ausiliaria.

ALLEGATO XXX: PRESCRIZIONE PER I SEGNALI ACUSTICI

Il segnale acustico deve:

- Avere un **LIVELLO SONORO nettamente superiore al rumore di fondo**;
- Essere **UDIBILE**, senza però essere eccessivo o doloroso;
- Facilmente **RICONOSCIBILE** da altri segnali acustici e da altri rumori di fondo;
- Se il dispositivo emette un segnale acustico con frequenza costante e variabile, **la frequenza variabile andrà impiegata per segnalare un livello più elevato di pericolo o una maggiore urgenza di intervento**;
- Il **SUONO** di un segnale di SGOMBERO deve essere CONTINUO.

D.M. 10 MARZO 1998 - CRITERI GENERALI DI SICUREZZA ANTINCENDIO E PER LA GESTIONE DELL'EMERGENZA NEI LUOGHI DI LAVORO

Restano ancora valide nel contempo, le prescrizioni contenute nel **D.M. 10 marzo 1998** che vanno ad integrare quanto previsto nel **T.U.**, **nella parte di definizione delle misure per la rilevazione e l'allarme in caso d'incendio**.

1. TIPOLOGIE DI ALLARME

Luoghi di grandi dimensioni:

- Solo allarme di tipo elettrico con segnale chiaramente udibile in tutto il luogo di lavoro o in quelle parti dove l'allarme è necessario;
- Obbligo di segnale ottico ove quello acustico non è sufficiente a causa del rumore di fondo o di altre ragioni (uso DPI, persone audiollese, ecc.).

2. PROCEDURE DI ALLARME

A) A "unica fase" Al suono di allarme prende il via l'evacuazione totale;

B) A "2 o più fasi" (progressiva);

Quando per la complessità dei luoghi è necessario procedere ad una evacuazione a fasi successive, vengono utilizzati suoni diversi per indicare stadi diversi di allarme.

3. EVACUAZIONE A FASI SUCCESSIVE

- **Allarme con suono continuo** (a frequenza variabile T.U.) per **EVACUAZIONE** nell'area interessata dall'emergenza;
- **Allarme con suono intermittente** per **ALLERTAMENTO** o **PREALLARME** nelle altre aree.

Il **PREALLARME** potrà trasformarsi in **EVACUAZIONE** se l'emergenza coinvolgerà tutte le aree.

Per completezza si richiamano anche i riferimenti normativi per il costruttore d'apparecchi di segnalazione e le norme relative all'installazione e manutenzione degli impianti.

NORMA UNI EN 54-3

Norme di riferimento per il costruttore

Requisiti:

- **Scopo:** avvertire le persone di una situazione di emergenza;
- **Natura del requisito sonoro:** gamma di frequenza, modello temporale, livello di uscita;
- **Livello sonoro:** compreso tra 65 dB (A) e 120 dB (A);
- **Grado di protezione IP:** (IP 21 C interno, IP 33 C esterno).

NORMA UNI 9795

Norme di riferimento per chi progetta e chi installa un impianto. La Norma UNI 9795 fornisce gli elementi necessari per la progettazione, l'installazione e la manutenzione degli impianti secondo la regola d'arte.

NORMA UNI 11224

Controllo iniziale e manutenzione dei sistemi di rilevazione incendi. Descrive le procedure per il controllo iniziale, la sorveglianza e il controllo periodico, la manutenzione e la revisione dei sistemi fissi automatici di rilevazione, di segnalazione manuale e di allarme d'incendio.

Il **D. Leg.vo n. 81 del 9 aprile 2008** (normativa in tema di sicurezza sui luoghi di lavoro), obbliga a porre in atto procedure per l'individuazione di tutti i possibili fattori di rischio e alla messa in atto delle misure previste. Il presente Decreto Legislativo si applica a tutti i settori di attività, privati e pubblici, e a tutte le tipologie di rischio.

OBBLIGHI

TITOLO I - PRINCIPI COMUNI, CAPO III, SEZIONE 1 | TUTELA E OBBLIGHI

Art. 15, 1. Misure Generali di Tutela

- a) La valutazione di tutti i rischi per la salute e la sicurezza.
- u) Le misure di emergenza da attuare in caso di primo soccorso, di lotta antincendio, di evacuazione dei lavoratori e di pericolo grave ed immediato.
- v) L'uso di segnali di avvertimento e di sicurezza.
- z) La regolare manutenzione di ambienti, attrezzature, impianti, con particolare riguardo ai dispositivi di sicurezza, in conformità alle indicazioni dei fabbricanti.

Art. 17, 1. Obblighi del datore di lavoro non delegabili

- a) La valutazione di tutti i rischi con la conseguente elaborazione del documento previsto dall'art. 28 (Valutazione dei Rischi).

Art. 18, 1. Obblighi del datore di lavoro e del dirigente

- h) Adottare le misure per il controllo delle situazioni di rischio in caso di emergenza e dare istruzioni affinché i lavoratori, in caso di pericolo grave, immediato ed inevitabile, abbandonino il posto di lavoro o la zona pericolosa.
- t) Adottare le misure necessarie ai fini della prevenzione incendi e dell'evacuazione dei luoghi di lavoro, nonché per il caso di pericolo grave ed immediato, secondo le disposizioni di cui all'art. 43. Tali misure devono essere adeguate alla natura dell'attività, alle dimensioni dell'azienda o dell'unità produttiva, e al numero delle persone presenti.
- z) Aggiornare le misure di prevenzione in relazione ai mutamenti organizzativi e produttivi che hanno rilevanza ai fini della salute e sicurezza del lavoro, o in relazione al grado di evoluzione della tecnica della prevenzione incendi e della protezione.

TITOLO II - LUOGHI DI LAVORO, CAPO I | DISPOSIZIONI GENERALI

Art. 64 - Obblighi del datore di lavoro

- c) I luoghi di lavoro, gli impianti e i dispositivi vengono sottoposti a regolare manutenzione tecnica e vengono eliminati, quanto più rapidamente possibile, i difetti rilevati che possono pregiudicare la sicurezza e la salute dei lavoratori.
- d) I luoghi di lavoro, gli impianti e i dispositivi vengono sottoposti a regolare pulitura, onde assicurare condizioni igieniche adeguate.
- e) Gli impianti e i dispositivi di sicurezza destinati alla prevenzione vengono sottoposti a regolare manutenzione e al controllo del loro funzionamento.

TITOLO I - PRINCIPI COMUNI, CAPO III, SEZIONE I

Art. 22 - Obblighi dei progettisti

1.1 I progettisti dei luoghi di lavoro, dei posti di lavoro e degli impianti rispettano i principi generali di prevenzione in materia di salute e sicurezza sul lavoro al momento delle scelte progettuali e scelgono attrezzature, componenti e dispositivi di protezione rispondenti alle disposizioni legislative e regolamentari in materia.

Art. 23 - Obblighi dei fabbricanti e dei venditori

1. Sono vietati la fabbricazione, la vendita, il noleggio e la concessione in uso di attrezzature di lavoro, dispositivi di protezione individuali ed impianti non rispondenti alle disposizioni legislative e regolamentari vigenti in materia di salute e sicurezza sul lavoro.

Art. 24 - Obblighi degli installatori

1. Gli installatori e montatori di impianti, attrezzature di lavoro o altri mezzi tecnici, per la parte di loro competenza, devono attenersi alle norme di salute e sicurezza sul lavoro, nonché alle istruzioni fornite dai rispettivi fabbricanti.

SANZIONI

TITOLO I, CAPO IV, SEZIONE I

Art. 55 - Sanzioni per il datore di lavoro e il dirigente (violazione Art. 17, Art. 18)

Art. 57 - Sanzioni per i progettisti, i fabbricanti, i fornitori e gli installatori (violazione Art. 22, 23, 24)

TITOLO II, CAPO II

Art. 68 - Sanzioni per il datore di lavoro (violazione Art. 64)

CRITERI DI APPLICAZIONE

D.M. n. 37 del 22/01/2008 I REGOLAMENTO IN MATERIA DI ATTIVITÀ DI INSTALLAZIONE DEGLI IMPIANTI ALL'INTERNO DEGLI EDIFICI

Art.5 Progettazione Impianti

1. Per l'installazione, la trasformazione l'ampliamento degli Impianti di cui all'Art. 1, comma 2, lettere a), b), c), d), e), g), è redatto un Progetto.

Fatta salva l'osservanza delle normative più rigorose in materia di progettazione:

- nei casi indicati al comma 2, il Progetto è redatto da un Professionista iscritto all'Albo Professionale secondo la specifica competenza tecnica richiesta;
- negli altri casi, il Progetto come specificato all'Art. 7, comma 2, è redatto, in alternativa, dal Responsabile Tecnico dell'Impresa Installatrice.

Per poter applicare correttamente le norme, è necessario da un lato conoscere le reali condizioni ambientali di impiego del segnale acustico di allarme evacuazione (e cioè valutare fattori esterni come ad esempio la rumorosità di fondo, l'area da ricoprire, la presenza di ostacoli quali barriere, muri o macchinari e quella di eventuali altri segnali acustici) **e considerare le due variabili del segnale acustico - intensità sonora e frequenze misurate in dB (decibel) e in Hz (Hertz) - per determinare nel caso concreto il dispositivo o i dispositivi più idonei ed efficaci.**

Per scegliere i giusti dispositivi e la giusta quantità necessaria, è fondamentale procedere ai rilevamenti ambientali, riportando i risultati delle rumorosità di fondo rilevate sulle planimetrie delle aree da adeguare; valutare sempre con attenzione le caratteristiche di tali ambienti in cui occorre realizzare l'impianto: rumorosità di fondo, area da ricoprire, presenza di eventuali barriere, ostacoli, muri, macchinari e la presenza di altri avvisatori acustici. Non è possibile infatti valutare a priori l'esatto numero e tipologia dei dispositivi da installare, senza aver prima effettuato le necessarie **rilevazioni ambientali. I rilevamenti dovranno essere eseguiti con fonometro, soprattutto nei punti più critici** (vicino a grosse fonti di rumore come macchinari, presse, linee automatiche robotizzate, ecc). In questi casi si rende necessaria l'installazione delle sirene **SEV anche in prossimità di queste fonti di rumore eccezionali** e comunque occorre sempre considerare che il suono di allarme **deve superare di almeno 15 dB** il rumore di fondo nei punti più critici (**divario previsto dalla Norma Europea EN 457**).

CRITERI DI SCELTA DISPOSITIVI LINEA **ESCAPE**

In linea di massima si possono comunque fornire alcune indicazioni generali per la scelta e l'applicazione dei nostri dispositivi acustici della Linea **ESCAPE**; tali dati andranno verificati di volta in volta nei casi concreti ed opportunamente modificati in funzione delle variabili ambientali esistenti. Partendo dalle rilevazioni fonometriche ambientali la scelta della sorgente viene effettuata sulla base delle reali condizioni di impiego come richiesto dal D.M. 10 marzo 1998.

Analizzando le fasi necessarie per arrivare alla corretta scelta dei dispositivi e della progettazione dell'impianto occorre considerare:

1. **Livello di pressione acustica: Decibel dB(A)**
2. **Campo di frequenza del suono: Hertz (Hz)**
3. **Tipologia di suono**
4. **Distanza tra dispositivo e destinatario**
5. **Presenza di altre fonti di rumore**
6. **Tipologia di prodotto**

1. LIVELLO ACUSTICO: dB(A)

I dati in dB (A) relativi ai prodotti Sirena sono misurati in **camera anecoica alla distanza di 1 metro sull'asse principale di emissione**. Occorre sempre tenere presente che tali dati possono aumentare da 2 a 4 dB per l'effetto eco ma possono diminuire in presenza di condizioni ambientali complesse.

2. FREQUENZE: Hz

L'efficacia di un segnale acustico non dipende solo dalla sua intensità sonora ma anche molto dalle sue frequenze.

- I **suoni a basse frequenze** risultano essere meglio accettabili all'udito, sono più udibili e identificabili e si diffondono a maggiore distanza, superando eventuali barriere acustico/ambientali frapposte fra il punto di emissione e l'area di ricezione;
- I **suoni ad alte frequenze** al contrario sono più fastidiosi e meno tollerabili dagli organi dell'udito, sono meno identificabili, restano circoscritti in ambienti limitati nello spazio, non superano barriere ed ostacoli interposti.

È opportuno ricordare come il segnale acustico:

- non deve essere doloroso
- non deve provocare reazioni di panico
- non deve essere superiore ai 120 dB*
- non inferiore ai 65 dB*.

* Norma UNI EN 54-3

Inoltre quando il rumore di fondo è superiore a 95 dB devono essere utilizzati anche segnali addizionali, quali i segnali luminosi.

3. TIPOLOGIA DI SUONO:

I segnalatori acustici della Linea **ESCAPE** possono emettere 4 suoni da scegliere fra 8 tonalità diverse, per soddisfare ogni esigenza:

ALLERTAMENTO	suono INTERMITTENTE
EVACUAZIONE 1	suono BITONALE (frequenza variabile T.U.)
EVACUAZIONE 2	suono LINEARE
INCENDIO	suono SWEEP

DIAGRAMMA POLARE POLAR DIAGRAM DIAGRAMME POLAIRE

Output Response (Meas Mic) - slice
● 5,05 kHz

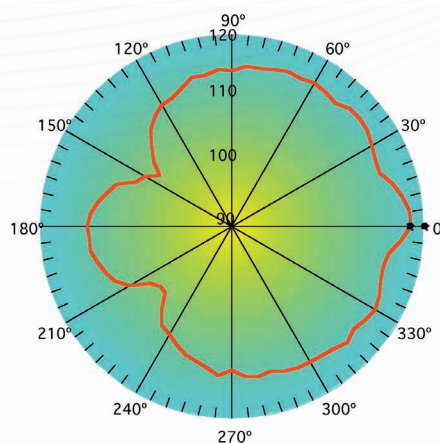

Esempio di propagazione del suono nello spazio di una sirena evacuazione linea **ESCAPE**

Sound propagation example of one of our **ESCAPE** evacuation siren

Exemple de propagation du son dans l'espace d'une sirène de la gamme **ESCAPE**

Cursor values
Frequency: 5050 Hz
Magnitude: 118 dB/20u Pa
Angle: 0.00 Degree

4. DISTANZA TRA DISPOSITIVO E DESTINATARIO

Occorre sempre garantire una corretta diffusione del suono in modo che il segnale acustico sia udibile da tutte le persone presenti, senza essere eccessivo o doloroso come indicato dalle norme di legge.

m	dB (A)																									
1	65	70	75	80	85	90	92	94	96	98	100	102	104	106	108	110	112	114	116	118	120	122	124	126	128	130
2	59	64	69	74	79	84	86	88	90	92	94	96	98	100	102	104	106	108	110	112	114	116	118	120	122	124
3	55	60	65	70	75	80	82	84	86	88	90	92	94	96	98	100	102	104	106	108	110	112	114	116	118	120
5	51	56	61	66	71	76	78	80	82	84	86	88	90	92	94	96	98	100	102	104	106	108	110	112	114	116
10	45	50	55	60	65	70	72	74	76	78	80	82	84	86	88	90	92	94	96	98	100	102	104	106	108	110
20	39	44	49	54	59	64	66	68	70	72	74	76	78	80	82	84	86	88	90	92	94	96	98	100	102	104
30	35	40	45	50	55	60	62	64	66	68	70	72	74	76	78	80	82	84	86	88	90	92	94	96	98	100
50	=	36	41	46	51	56	58	60	62	64	66	68	70	72	74	76	78	80	82	84	86	88	90	92	94	96
100		=	=	40	45	50	52	54	56	58	60	62	64	66	68	70	72	74	76	78	80	82	84	86	88	90
200				=	39	44	46	48	50	52	54	56	58	60	62	64	66	68	70	72	74	76	78	80	82	84
300					=	40	42	44	46	48	50	52	54	56	58	60	62	64	66	68	70	72	74	76	78	80
500						=	38	40	42	44	46	48	50	52	54	56	58	60	62	64	66	68	70	72	74	76
1000							=	=	=	38	40	42	44	46	48	50	52	54	56	58	60	62	64	66	68	70
2000										=	=	=	38	40	42	44	46	48	50	52	54	56	58	60	62	64
3000													=	=	38	40	42	44	46	48	50	52	54	56	58	60
5000															=	=	38	40	42	44	46	48	50	52	54	56

5. PRESENZA DI ALTRE FONTI DI RUMORE

Occorre sempre considerare che il suono di allarme **deve superare di almeno 15 dB** il rumore di fondo nei punti più critici, **divario previsto dalla Norma Europea EN 457**.

6. TIPOLOGIA DI PRODOTTO

Nella scelta del prodotto è bene prevedere un **SEGNALATORE ACUSTICO** che emetta almeno due suoni, con la giusta potenza sonora e la frequenza bassa.

Meglio se è autoalimentato e se dispone di microprocessore per il monitoraggio dello stato di funzionamento, come le sirene della linea **ESCAPE**.

Nella scelta dei prodotti occorre inoltre considerare il **tipo di alimentazione** che può essere di due tipologie:

- alimentazione diretta da rete
- autoalimentazione

Quest'ultima è da preferire in quanto consente al dispositivo di funzionare anche in assenza di rete primaria.

SORVEGLIANZA, CONTROLLI E MANUTENZIONE

I dispositivi di segnalazione acustica di allarme devono essere soggetti, come le altre attrezzature antincendio, a **sorveglianza, controlli semestrali e manutenzione come previsto dal D.M. 10 marzo 1998 Art. 4 e all'Allegato VI**.

Prevedere sempre un piano di manutenzione semestrale e inoltre effettuare le verifiche cicliche per eventuale ricondizionamento dell'impianto.





Applicare le norme:

UNI 9795 che prevede il mantenimento delle condizioni di efficienza dei sistemi di competenza dell'utente che deve provvedere:

- al controllo che i componenti siano conformi alle norme EN 54:3
- al controllo che la posa in opera sia stata eseguita in conformità alle norme vigenti
- all'esecuzione di prove di funzionamento
- alla continua sorveglianza dei sistemi
- alla loro manutenzione

UNI 11224 che prevede il controllo iniziale e la manutenzione degli impianti.

TIPI DI COLLEGAMENTO SIRENE SEV / SEV SIRENS TYPE OF CONNECTION / TYPE DE CABLAGE SIRENES SEV

CABLAGGIO TRADIZIONALE / TRADITIONAL WIRING CABLAGE TRADITIONNEL	SERIALE - LOOP CHIUSO / SERIAL - CLOSED-LOOP EN SERIE - BOUCLE FERMEE
<p>RADIALE (PARALLELO): comandi di ALLERTAMENTO - EVACUAZIONE E CESSATO ALLARME realizzato da un unico punto</p> <p>IN CASCATA: comandi generali di ALLERTAMENTO, EVACUAZIONE E CESSATO ALLARME. TIPICO di collegamento di singola sirena</p>	<p>Possibilità di programmare la CENTRALE ottenendo tutte le soluzioni possibili per soddisfare l'esigenza applicativa: ALLARMI LOCALIZZATI (per zone) e GENERALI</p>
<p> RADIAL (PARALLEL): WARNING, EVACUATION and ALL CLEAR ALARM with a single control point</p> <p>CASCADE: general commands of WARNING, EVACUATION and ALL CLEAR ALARM. Typical connection of a single siren</p>	<p> Possibility to program the CENTRAL UNIT, in order to obtain all possible solutions: LOCALIZED (area-based) and GENERAL ALARMS.</p>
<p> PARALLELE : déclenchement de l'ALERTE - EVACUATION et FIN d'ALARME depuis un seul même point.</p> <p>EN CASCATE: déclenchement de l'ALERTE - EVACUATION et FIN d'ALARME. S'applique quand il y a une seule sirène</p>	<p> Possibilité d'installer une CENTRALE et avoir accès à toutes les solutions possibles pour satisfaire l'application : ALARMES LOCALISEES (par zone) et ALARME GENERALE</p>

Con questa linea di prodotti, Sirena si prefigge l'obiettivo di offrire la gamma più completa di dispositivi per ogni applicazione, tenendo conto che non si fornisce solo una serie di prodotti ma anche e soprattutto servizi a tutela della salute pubblica.

Al fine di offrire un servizio a chi progetta e/o realizza un impianto di evacuazione, è disponibile in Sirena un pannello dimostrativo che può essere utile per valutare concretamente le caratteristiche e l'efficienza dei dispositivi **ESCAPE** in varie situazioni ambientali.



ESCAPE RANGE SELECTION CRITERIA

In the following pages some general indications for selection and application of our **ESCAPE** range acoustic devices, obviously these data must be checked in each individual case and revised as appropriate.

For a correct choice following criteria should be considered:

1. **Sound pressure level: Decibel dB(A)**
2. **Frequency range: Hertz (Hz)**
3. **Sound type**
4. **Distance between device and operator**
5. **Presence of other noise sources**
6. **Product type**

1. SOUND PRESSURE LEVEL: DECIBEL dB(A)

The sound output dB(A) data of Sirena's products are measured in an **anechoic testing chamber at a distance of one meter from the axis of the device**. An increase of 2/4 dB due to the echo effect, as well as a decrease due to complex environmental conditions, must be considered.

2. FREQUENCY RANGE: HERTZ (Hz)

The suitability of an audible alarm does not depend only on sound intensity, but also on its frequencies.

- **Low frequency bass sounds** are more easily identifiable and can reach long distance, overcoming eventual acoustic barriers between the emission point and the sound reception point;

- **High frequency sounds**, on the contrary, are more disturbing, less tolerable and identifiable and cannot overcome acoustic barriers.

It should be noted that the acoustic signal must be audible:

- without being excessive or painful
- without creating panic
- should not exceed 120 dB*
- should not be less than 65 dB*

* According to UNI EN 54-3

Moreover when the background noise is very high, additional luminous warning devices must be installed.

3. SOUND TYPE

Acoustic warning devices of **ESCAPE** range benefit from 4 sounds to be selected from a total of 8 different sounds, to meet any kind of customers' requirements:

WARNING	INTERMITTENT sound
EVACUATION 1	TWO-TONE sound
EVACUATION 2	CONTINUOUS sound
FIRE ALARM	SWEEP sound

See polar diagram on page 284.

4. DISTANCE BETWEEN DEVICE AND OPERATOR

It is necessary to ensure a correct sound diffusion, so that the acoustic signal could be audible without being excessive or painful, according to the norms in force.

5. PRESENCE OF OTHER NOISE SOURCES

An alarm sound **must be 15 dB higher** than the level of ambient noise, according to **EN 457 Norm**.

6. PRODUCT TYPE

An ACOUSTIC DEVICE with two sounds, the right sound output and a low frequency should be foreseen, better if battery-powered and with a microprocessor for function monitoring. Our **ESCAPE** range benefits from all these characteristics.

Selection criterion is also the **power supply** type:

- mains power supply
- battery-operation

The latter should be preferred, as the device operates even in case of power failure.

See table **SEV SIRENS TYPE OF CONNECTION** on page 285.

With this range Sirena offers a complete range, delivering not only products but also services for the protection of public health. A demonstration panel is available in Sirena, useful to evaluate **ESCAPE** warning devices according to their characteristics and efficiency.



CHOIX DES DISPOSITIFS LIGNE ESCAPE

Les pages suivantes ont pour but de fournir un maximum d'informations utiles pour faire le bon choix parmi nos dispositifs acoustiques de la ligne **ESCAPE** ; ces données sont variables en fonction des caractéristiques propres à l'environnement de l'installation. A partir des mesures photométriques de l'environnement, le choix de la source se fait en fonction des conditions réelles d'utilisation.

Afin de choisir le dispositif correct en fonction de l'application, il faut analyser les éléments suivants :

1. **Niveau de pression acoustique : Decibel dB(A)**
2. **Champs de fréquence du son : Hertz (Hz)**
3. **Types de son**
4. **Distance entre dispositif et opérateur**
5. **Présence d'autres sources de bruit**
6. **Type de produit**

1. NIVEAU ACOUTISQUE : DECIBEL dB(A)

Les données en dB (A) relatives aux produits Sirena sont mesurés en **chambre anéchoïque à une distance de 1 mètre sur l'axe principal d'émission**. Il faut toujours prendre en compte que ces données sont variables en fonction des conditions réelles d'utilisation.

2. FREQUENCES : HERTZ (Hz)

L'efficacité d'un signal acoustique ne dépend pas seulement de son intensité mais aussi de sa fréquence.

- **Les sons basses fréquences** sont plus agréables pour l'auditeur, ils sont plus facilement perçus et identifiables et se diffusent sur de plus grandes distances, en passant éventuellement à travers les obstacles entre la source d'émission et la zone de réception.

- **Les sons hautes fréquences** au contraire sont plus gênants pour l'auditeur, plus difficilement identifiables et restent limités dans l'espace, ils ne traversent pas les obstacles.

Le signal acoustique doit respecter les éléments suivants :

- Ne doit pas être douloureux
- Ne doit pas provoquer de réactions de panique
- Ne doit pas être supérieur à 120 dB*
- Ne doit pas être inférieur à 65 dB*

* Norme UNI EN 54-3

Lorsque le niveau sonore ambiant est élevé, il est recommandé d'ajouter un signal lumineux à l'installation.

3. TYPES DE SON

Les sirènes de la gamme **ESCAPE** peuvent émettre 4 sons sélectionnés parmi les 8 tonalités disponibles afin de satisfaire toutes les exigences :

ALERTE	son INTERMITTENT
EVACUATION 1	son BITONAL
EVACUATION 2	son LINEAIRE
INCENDIE	son SWEEP

Voir diagramme polaire à la page 284.

4. DISTANCE ENTRE DISPOSITIF ET AUDITEUR

Il faut toujours garantir une diffusion du son de façon à ce que le son soit audible par toutes les personnes présentes, sans être excessive ou douloureuse comme indiqué dans les normes.

5. PRESENCE D'AUTRES SOURCES DE BRUIT

Selon la **Norme Européenne EN 457**, la puissance sonore du signal d'alerte **doit toujours être supérieur d'au moins 15 dB** par rapport au niveau sonore des zones les plus critiques.

6. TYPE DE PRODUIT

Dans le choix du produit, il est recommandé de choisir une SIRENE émettant au moins 2 sons, avec la puissance et la basse fréquence adaptée. Il est aussi avantageux que les sirènes soient autoalimentées et équipées de microprocesseurs permettant le contrôle de leur état de fonctionnement, c'est le cas de la gamme **ESCAPE**.

La **tension d'alimentation** est aussi à prendre en compte, selon deux possibilités :

- alimentation directement par le réseau
- auto-alimentation

L'auto-alimentation est particulièrement recommandé car le système doit continuer à fonctionner même en cas de panne d'électricité générale.

Voir tableau **TYPE DE CABLAGE SIRENS SEV** à la page 285.

Avec cette gamme de produits, Sirena propose des solutions pour toutes les applications. Il ne s'agit pas seulement de fournir des produits, mais surtout d'assurer la sécurité des personnes.

Dans l'objectif d'assister ceux qui projette ou installent les systèmes d'évacuation, il est disponible chez Sirena un panneau de démonstration qui permet d'illustrer concrètement les caractéristiques et l'efficacité des dispositifs **ESCAPE** dans différents environnements.

VADEMECUM

FASI PRELIMINARI E CONSIGLI PER LA CORRETTA PROGETTAZIONE DEGLI IMPIANTI DI EVACUAZIONE, APPLICANDO LE LEGGI VIGENTI E LE NORME DI RIFERIMENTO

Per procedere alla stesura di un progetto occorre preventivamente conoscere ed applicare Leggi e Norme di riferimento. L'Azienda che richiede un preventivo per un impianto di evacuazione avrà sicuramente messo in atto le procedure che prevedono inizialmente un'attenta valutazione dei rischi della propria realtà.

1. PUNTO DI PARTENZA: LA VALUTAZIONE DEI RISCHI

T.U. - D.Leg.vo n. 81 Aprile 2008. VALUTAZIONE DEI RISCHI

Titolo I, Capo 1, Art. 2 - Definizione

q) valutazione globale e documentata di tutti i rischi per la salute e sicurezza dei lavoratori presenti nell'ambito dell'organizzazione in cui essi lavorano.

Titolo I, Capo 1, Art. 3 - Campo di Applicazione

"Il presente decreto legislativo si applica a tutti i settori di attività, privati e pubblici, e a tutte le tipologie di rischio".

Titolo I, Capo 3, Sezione 1 - Principi Comuni - Misure di tutela e obblighi

Rif. pag 283

Si procede con la scelta dei prodotti idonei per l'impianto di EVACUAZIONE e quindi occorre tenere presente che il T.U. conferma quanto già previsto dal D.Leg.vo 10 marzo 1998 e cioè che occorre applicare DISPOSITIVI ACUSTICI e DISPOSITIVI LUMINOSI con le caratteristiche indicate negli allegati XXX e XXIX.

2. PRESCRIZIONE PER LA SCELTA DEI DISPOSITIVI

T.U. - D.Leg.vo n. 81 Aprile 2008. VALUTAZIONE DEI RISCHI

Allegato XXX - Prescrizione per i SEGNALI ACUSTICI

Rif. pag 282

Allegato XXIX - Prescrizione per i SEGNALI LUMINOSI

Rif. pag 282

UNI EN 54-3 - Sistemi di rilevazione e di segnalazione d'incendio. Dispositivi Sonori

Rif. pag 283

Allegato XXXI - Prescrizione per la COMUNICAZIONE VERBALE

UNI EN 54-3/A2 - Sistemi antincendio: Parte 3 - Ambienti di lavoro con notevole presenza di pubblico

- Allarme iniziale riservato agli addetti;
- Successivo avvio delle fasi di evacuazione necessarie;
- Utilizzo di allarmi sonori di preallarme, evacuazione ed impiego di altoparlanti per messaggi pre-registrati con la priorità su tutti gli altri segnali sonori (IEC 60849 - UNI ISO 7240-19).

Contestualmente alla scelta dei dispositivi idonei occorre prevedere la loro applicazione e quindi il funzionamento e la gestione dell'impianto.

3. SCELTA DELLA TIPOLOGIA DI IMPIANTO

D.M. 10 Marzo 1998 all. IV, riprende i concetti espressi nel D.M. 493/1996 ma fa un passo ulteriore sottolineando che l'allarme deve far scattare la procedura per l'evacuazione del luogo di lavoro, nonché le procedure d'intervento.

Nel caso di luoghi di lavoro di modeste dimensioni e a rischio di incendio basso o medio, il sistema di allarme può essere di tipo semplice, come ad esempio un allarme dato a voce, che potrà ritenersi adeguato allo scopo, qualora tutto il personale lavori nello stesso ambiente. Qualora il sistema manuale non sia adeguato al luogo di lavoro, bisognerà procedere ad installare un sistema di allarme elettrico a comando manuale, realizzato secondo la normativa tecnica vigente.

Nei luoghi di lavoro di grandi dimensioni e più complessi il sistema di allarme deve essere di tipo elettrico e il segnale di allarme udibile in tutto il luogo di lavoro o in quelle parti dove l'allarme è necessario. Nel caso in cui il livello di rumore non possa essere elevato o nelle situazioni in cui il solo allarme acustico non sia sufficiente, dovranno essere installati in aggiunta agli allarmi acustici anche dei segnalatori ottici, i quali non potranno mai essere utilizzati come unico mezzo di allarme.

Per quanto concerne i sistemi di allarme, le procedure possono essere:

Rif. pag. 282

4. CORRETTA PROGETTAZIONE DELL'IMPIANTO

D.M. n. 37 del 22/01/2008 - Regolamento in materia di attività di Installazione degli Impianti all'interno degli Edifici - Art. 5 - PROGETTAZIONE IMPIANTI

Rif. pag 283

I Progetti degli Impianti sono elaborati secondo la Regola dell'Arte in conformità alla vigente normativa e alle indicazioni delle Guide e alle Norme dell'UNI, del CEI o di altri Enti di Normalizzazione appartenenti agli Stati Membri dell'U.E. o che sono parti contraenti dell'accordo sullo spazio economico europeo, si considerano redatti secondo la Regola dell'Arte. (L. 186/68 aggiornata).

I Progetti devono contenere almeno:

- gli schemi dell'impianto
- i disegni planimetrici
- una relazione tecnica sulla consistenza e sulla tipologia dell'installazione, della trasformazione o dell'ampliamento dell'impianto stesso, con particolare riguardo alla tipologia e alle caratteristiche dei materiali e componenti da utilizzare e alle misure di prevenzione e di sicurezza da adottare.

Occorre procedere con i rilievi fonometrici della rumorosità di fondo ed effettuare le prove di suono per stabilire la tipologia, la quantità e la dislocazione dei dispositivi acustici, tenendo presente che il segnale acustico, per essere chiaramente udibile, deve avere un livello in dB maggiore del livello della rumorosità di fondo.

- Premesso che, la legislazione vigente in materia di segnalazione acustica di allarme evacuazione non fornisce indicazioni in merito al livello sonoro del rispetto alla "rumorosità di fondo", è possibile, seguendo quanto previsto dalle Norme UNI 9795 e della Direttiva Macchine (2006/42/CE) e dalla Norma Europea UNI EN ISO 7731 che sostituisce la norma EN 457, prevedere che il segnalatore acustico emetta un segnale di almeno 15 dB superiore rispetto alla rumorosità di fondo.

Titolo 1, Capo 3 - Art. n. 22 - OBBLIGHI dei PROGETTISTI

Rif. pag. 283

5. INSTALLAZIONE E MANUTENZIONE DELL'IMPIANTO

NORMA UNI 9795 Installazione e manutenzione degli impianti antincendio

Rif. pag. 283

NORMA UNI 11224 Controllo iniziale e manutenzione dei sistemi di rivelazione incendi

Rif. pag. 283

Titolo 2, Capo 1 - LUOGHI DI LAVORO DISPOSIZIONI GENERALI

Art. n. 64 - Obblighi del datore di lavoro

Rif. pag. 283

Titolo 1, Capo 3 - Art. n. 24 OBBLIGHI degli INSTALLATORI

Rif. pag. 283

Quindi occorre definire i componenti (sirene, luci, pulsanti, box di comando, centrale, ripetitore remoto e dispositivi vari in base all'esigenza) tenendo presente:

- **Livello di pressione acustica: Decibel (dB)**
- **Campo di frequenza del suono: Hertz (Hz)**
- **Distanza tra dispositivo e destinatario**
- **Presenza di altre fonti di rumore**
- **Autonomia di funzionamento di minimo 30 minuti in assenza di alimentazione rete primaria**

• **FILOSOFIA di FUNZIONAMENTO** dell'impianto tenendo presente che la CENTRALE SEO SEV SY PCS offre varie soluzioni per soddisfare in pieno ogni esigenza del committente, ad esempio:

1. **ALLERTAMENTO, EVACUAZIONE, CESSATO ALLARME GENERALE**
2. **ALLERTAMENTO LOCALE E/O ALLERTAMENTO, EVACUAZIONE PER ZONA E ALLERTAMENTO, EVACUAZIONE, CESSATO ALLARME GENERALE**
3. **EVACUAZIONE LOCALE CHE AVVIA AUTOMATICAMENTE L'ALLERTAMENTO NELLE ZONE LIMITROFE E ALLERTAMENTO, EVACUAZIONE, CESSATO ALLARME GENERALE**
4. **ALLERTAMENTO SILENTE E ALLERTAMENTO E/O EVACUAZIONE PER ZONA E ALLERTAMENTO, EVACUAZIONE, CESSATO ALLARME GENERALE**
5. **ALTRE SOLUZIONI IN BASE ALL'ESIGENZA.**

Poi si procederà con la denominazione dei componenti in base alla loro dislocazione per consentire la corretta programmazione della CENTRALE.

Dette denominazioni/descrizioni verranno scritte sul display della CENTRALE sia in caso di attivazione impianto sia nel caso di eventuali anomalie: mancanza rete, batteria scarica, unità di suono guaste e linea interrotta.



VADEMECUM

PRELIMINARY STAGES AND EVACUATION SYSTEM DESIGN, ACCORDING TO THE NORMS IN FORCE

Project preparation includes first of all application of the norms in force. A quotation for an evacuation installation foresees procedures for a careful risks evaluation.

CHOICE OF SYSTEM TYPE

In case of medium-sized premises and with low or medium fire risk, a simple alarm system such as a voice alarm should be appropriate.

In large-sized premises, the alarm system must be electric and the acoustic signal must be audible in every places. In case the only acoustic signal is not sufficient, the use of luminous devices (together with acoustic alarms) becomes necessary. Luminous devices could not be used alone.

PROPER SYSTEM DESIGN

Projects must be "state of the art" and must conform with the norms in force according to UNI, IEC, Standardization Bodies belonging to the EU Member States.

Projects must have at least:

- system schemes
- planimetric drawings
- a technical report regarding type of installation, extension or transformation of an existing system, with the characteristics of materials and components that must be used, as well as prevention and safety measures.

Phonometric reliefs of background noise and sound tests must be carried out, to determine type and positioning of the acoustic devices, considering that an acoustic signal, to be audible, must have a dB level higher than the background noise level.

INSTALLATION AND MAINTENANCE

All components (sirens, beacons, call points, command box, central unit, repetition remote control panel and others) must be defined considering:

- **Sound pressure level: Decibel (dB)**
- **Sound Frequency range: Hertz (Hz)**
- **Distance between device and operator**
- **Presence of other noise sources**
- **Function autonomy of at least 30 min. in case of power failure**
- **FUNCTION PHILOSOPHY** of the system considering that the SEO SEV SY PCS CENTRAL UNIT offers different solutions to meet fully customer requirements, such as:

1. **WARNING, EVACUATION and GENERAL ALL CLEAR ALARM**
2. **LOCAL WARNING AND/OR WARNING, ZONE-BASED EVACUATION AND WARNING, EVACUATION and GENERAL ALL CLEAR ALARM.**
3. **LOCAL EVACUATION** ACTIVATING AUTOMATICALLY WARNING IN THE SURROUNDING AREAS AND WARNING, EVACUATION and GENERAL ALL CLEAR ALARM.
4. **SILENT WARNING** AND WARNING AND/OR ZONE-BASED EVACUATION AND WARNING, EVACUATION and GENERAL ALL CLEAR ALARM.
5. OTHER SOLUTIONS ACCORDING TO SPECIFIC NEED.

The denomination of the components according to their location allows the correct programming of the CENTRAL UNIT.

These denominations/descriptions will appear on the display of the CENTRAL UNIT whether in case of system activation or in case of anomalies: power supply failure, discharged battery, faulty or interrupted sirens.



REMARQUES

PHASES PRELIMINAIRES ET CONSEILS POUR LA CORRECTE ELABORATION DES INSTALLATIONS D'EVACUATION EN FONCTION DES LOIS ET DES NORMES EN VIGUEUR

Pour élaborer une installation il faut au préalable connaître les lois et les normes concernées. La société qui demande une offre pour un système d'évacuation devra nécessairement avoir fait expertiser le niveau de risque de son installation.

CHOIX DU TYPE D'INSTALLATION

Dans le cas de locaux de petites dimensions et où le risque d'incendie est faible ou moyen, et où tout le personnel travaille dans le même lieu, un système simple peut être suffisant, comme par exemple une alarme vocale. Si un système manuel n'est pas adapté au lieu de travail, il faudra alors installer un système d'alarme électrique à commande manuelle, réaliser selon la norme technique adaptée.

Dans les lieux de travail de grandes dimensions, le système doit être électrique et s'entendre partout où cela est nécessaire. Dans le cas où le niveau sonore est particulièrement élevé et qu'une signalisation sonore est insuffisante, il est recommandé d'installer une signalisation lumineuse supplémentaire. Ces derniers ne doivent cependant jamais être utilisés comme seuls signaux d'alarme.

BONNE CONCEPTION DU PROJET

Les projets sont établis en fonction des règlements et des indications en vigueur de l'UNI, de la CEI et des autres entités appartenant aux membres de l'UE ou qui font parties des accords économiques européens.

Les projets doivent comprendre au moins :

- Les schémas de l'installation
- Les plans
- Un rapport technique sur la structure et la typologie de l'installation, sur les éventuelles modifications ou transformations de l'installation, devront être précisés les caractéristiques du matériel et des composants à utiliser ainsi que les mesures de préventions à adopter.

Il faudra prendre des mesures des niveaux sonores de fond et effectuer des tests avec les sirènes, préciser les quantités et la localisation des dispositifs acoustiques en prenant en compte que la puissance sonore du signal d'alarme doit être supérieur au bruit de fond.

INSTALLATION ET ENTRETIEN

Il faut définir les composants (sirènes, feux, boutons poussoirs, boîtier de commande, centrale, remontée des défauts de fonctionnement et dispositifs divers en fonction des besoins) en prenant en compte :

- **Niveau de pression acoustique : Décibel (dB)**
- **Champs de fréquence du son : Hertz (Hz)**
- **Distance entre dispositif et opérateur**
- **Présence d'autres sources de bruit**
- **Autonomie de fonctionnement de minimum 30 minutes en cas d'absence de l'alimentation primaire.**
- **PHILOSOPHIE DE FONCTIONNEMENT**, la CENTRALE SEO SEV SY PCS offre de nombreuses options pour satisfaire toutes les applications :

1. **ALERTE, EVACUATION, FIN D'ALARME**
2. **ALERTE LOCALE ET/OU ALERTE EVACUATION DE ZONE ET ALERTE, EVACUATION, FIN D'ALARME**
3. **EVACUATION LOCALE** QUI ACTIVE AUTOMATIQUEMENT L'ALERTE DANS LES ZONES PROCHES, EVACUATION, FIN D'ALARME
4. **ALERTE SILENCIEUSE** ET ALERTE ET/OU EVACUATION DE ZONE ET ALERTE, EVACUATION, FIN D'ALARME
5. AUTRES FONCTIONS SELON LES BESOINS

Vient ensuite l'identification des différents composants du système ainsi qu'à la correcte programmation de la CENTRALE.

Les différents de l'installation seront apparents sur l'écran de la CENTRALE en cas d'activation ou d'anomalie du système : batterie faible, manque d'alimentation, pannes ou coupure de courant.



Sistemi per grandi aree Large area evacuation systems Systèmes d'alerte longue portée



*Per avere maggiori informazioni,
contattate il nostro ufficio commerciale
Please contact our sales department for further details
Pour toute information supplémentaire,
n'hésitez pas à consulter notre service commercial*



ICARO

Segnalazione Ostacolo Volo
Aircraft Warning Lights
Balisage Aérien



SIRENA



294 **Introduzione** **Introduction** **Introduction**

296 **Estratto tabella 6-3: Caratteristiche segnalatori ostacolo volo** **Extract from table 6-3: Characteristics of obstacles light** **Extrait du tableau 6-3 : Caractéristiques des feux d'obstacles**

297 **Posizionamento luci SOV** **Positioning of the Aircraft Warning Lights** **Positionnement Balisage Aérien**

304 **Luci Bassa Intensità** **Low Intensity Warning Lights** **Feux Basse Intensité**

- 304 NAVILITE
- 305 KIT NAVILITE D/N 230V AC
- 306 SOLAR NAVILITE
- 307 NAVILITE FAA L-810



308 **Luci Media Intensità** **Medium Intensity Warning Lights** **Feux Moyenne Intensité**

- 308 OBSTAFLASH LED
- 310 KIT OBSTAFLASH 120° 48V DC
- 312 KIT OBSTAFLASH 120° 110/240V AC
- 314 OBSTAFLASH LED 180°



316 **Luci Alta Intensità** **High Intensity Warning Lights** **Feux Haute Intensité**

- 316 OBSTAFLASH LED HI 110/240V AC



318 **Accessori e ricambi** **Accessories and spare parts** **Accessoires et pièces de rechange**

324 **Segnalatore perimetrale per eliporti** **Helipad perimeter light** **Feu de périmètre de plate-forme**

- 324 HELIX



326 **Luci veicoli aeroportuali** **Airport vehicle warning lights** **Feux pour les véhicules des aéroports**

- 326 AWL 810/C
- 327 FOLLOW-ME BAR





INTRODUZIONE

Sirena progetta, sviluppa e produce dispositivi per la segnalazione acustica e luminosa dal 1974. L'esperienza maturata ci consente di fornire i nostri Clienti con dispositivi di altissima gamma, adatti alle più svariate esigenze tecniche: dalla segnalazione industriale ai complessi sistemi di evacuazione, dalla segnalazione specifica per l'automazione alla segnalazione ostacolo volo, dalla segnalazione del traffico ai sofisticati sistemi antideflagranti.

Con oltre 40 anni di esperienza nel settore ed una presenza in oltre 60 paesi nel mondo, Sirena è la scelta migliore che possiate fare quando si tratta di trovare le giuste soluzioni per le vostre esigenze di segnalazione acustica e luminosa.

ICARO è la gamma per la Segnalazione Ostacolo Volo di Sirena. Sviluppata interamente su base LED, la linea **ICARO** a Bassa, Media ed Alta Intensità è la migliore soluzione che il mercato odierno vi possa offrire. Alte performance, facilità d'installazione e manutenzione virtualmente assente, permettono a Clienti ed Installatori di incrementare il valore aggiunto dei propri progetti. I dispositivi **ICARO** sono conformi alle normative ICAO e FAA e certificati CE.

Il nostro Team di esperti è in grado di guidarvi nella scelta della configurazione corretta per permettervi di raggiungere la soluzione migliore per le vostre esigenze oltre che la più alta efficienza economica.

Con una gamma completa di dispositivi per la Segnalazione Ostacolo Volo (Bassa Intensità Tipo A e B, Media Intensità Tipo A, B e C e Alta Intensità Tipo A), **ICARO** è la soluzione completa che state cercando.

Sirena è certificata UNI EN ISO 9001, 14001 e BS OHSAS 18001.



INTRODUCTION

Sirena designs, engineers and manufactures signaling devices since 1974. From Industrial Signaling Devices to Evacuation Systems, through Aircraft Warning Lights and Automation Devices, our expertise allows to deliver Customers with the highest quality signaling devices available on today's market.

With over 40 years of intense know-how and a presence in over 60 countries worldwide, Sirena is the best choice when it comes to satisfying your signaling needs.

ICARO is Sirena's Aircraft Warning Lights range. Engineered entirely on LED base, **ICARO**'s Low, Medium and High Intensity devices are one of the best products available today. High performance, easy installation and virtually zero maintenance, allow Customers and Installers to add considerable value to their projects. All devices conform to ICAO and FAA norms as well as CE marked.

Our expert Team will guide you to the right choice and will help you to determine the best and most cost efficient solutions for your projects.

With a complete range of devices (Low Intensity Type A and B, Medium Intensity Type A, B and C and High Intensity Type A), **ICARO** is the complete solution you are looking for.

Sirena is UNI EN ISO 9001, 14001 and BS OHSAS 18001 certified.



INTRODUCTION

Depuis 1974, Sirena conçoit, développe et fabrique des dispositifs de signalisation sonores et lumineux. L'expérience acquise nous permet de proposer à nos clients des produits de haute qualité adaptés aux exigences techniques les plus diverses : de la signalisation industrielle aux complexes systèmes d'évacuation, de la signalisation spécifique à l'automatisation au Balisage Aérien, de la signalisation de trafic aux sophistiqués systèmes antidéflagrants.

Avec plus de 40 ans d'expérience et sa présence dans plus de 60 pays du monde, Sirena est le meilleur choix lorsqu'il s'agit de trouver la solution acoustique et lumineuse satisfaisant vos exigences.

ICARO est la gamme de Balisage Aérien de Sirena. Développée exclusivement avec la technologie LED, la ligne **ICARO** à Basse, Moyenne et Haute Intensité est la meilleure solution offerte sur le marché aujourd'hui. Hautes performances, installation facile et maintenance presque nulle sont les avantages que nous offrons aux clients et installateurs. Les dispositifs **ICARO** sont conformes aux directives OACI et FAA, et sont certifiés CE.

Notre équipe d'expert à votre service vous guidera dans le choix de la meilleure configuration adaptée selon vos besoins.

Avec une gamme complète de dispositifs de Balisage Aérien (Basse Intensité Type A et B, Moyenne Intensité Type A, B et C et Haute Intensité Type A), **ICARO** est la solution complète que vous cherchez.

Sirena est certifiée UNI EN ISO 9001, 14001 et BS OHSAS 18001.

ALTA INTENSITÀ HIGH INTENSITY HAUTE INTENSITE

Dispositivi Segnalazione Ostacolo Volo ad Alta Intensità conformi alle normative ICAO Tipo A.

Basati su tecnologia LED, questi dispositivi offrono una luce bianca con intensità massima pari a 200.000 Cd in grado di soddisfare le applicazioni più esigenti. Vengono normalmente installati su strutture con altezza superiore ai 150 metri per la Segnalazione Ostacolo Volo diurna e crepuscolare.

- High Intensity Aircraft Warning Lights compliant to ICAO Type A regulation. 100% LED based, these devices offer a white light with a maximum intensity of 200.000 Cd satisfying the most demanding applications. Typically installed on structures over 150 meters, High Intensity devices are used for day and twilight marking.

- Dispositifs de Balisage Aérien à Haute Intensité conforment aux normes OACI Type A.

Développés avec technologie LED, ces dispositifs diffusent une lumière blanche d'une intensité maximale de 200.000 Cd satisfaisant les applications les plus exigeantes. Ils sont utilisés sur des installations hautes de plus de 150 mètres pour la signalisation de jour et au crépuscule.

MEDIA INTENSITÀ MEDIUM INTENSITY MOYENNE INTENSITE

Dispositivi Segnalazione Ostacolo Volo a Media Intensità conformi alle normative ICAO Tipo A, B, C e FAA L-864, L-865.

Basati su tecnologia LED, questi dispositivi offrono una luce bianca o rossa con intensità massima pari a 20.000 Cd in grado di soddisfare le applicazioni più esigenti. Vengono normalmente installati su strutture con altezza superiore ai 45 metri per la Segnalazione Ostacolo Volo diurna e notturna.

- Medium Intensity Aircraft Warning Lights compliant to ICAO Type A, B, C and FAA L-864, L-865 regulations.

100% LED based, these devices offer a white/red light with a maximum intensity of 20.000 Cd satisfying the most demanding applications. Typically installed on structures over 45 meters, Medium Intensity devices are used for day and night marking.

- Dispositifs de Balisage Aérien à Moyenne Intensité conforment aux normes OACI Type A, B et C et FAA L-864 et L-865.

Développés avec technologie LED, ces dispositifs diffusent une lumière blanche ou rouge d'une intensité maximale de 20.000 Cd satisfaisant les applications les plus exigeantes. Ils sont utilisés sur des installations hautes de plus de 45 mètres pour la signalisation de jour et de nuit.

BASSA INTENSITÀ LOW INTENSITY BASSE INTENSITE

Dispositivi Segnalazione Ostacolo Volo a Bassa Intensità conformi alle normative ICAO Tipo A, B e FAA L-810.

Basati su tecnologia LED, questi dispositivi offrono una luce rossa con intensità minima di 32 Cd in grado di soddisfare le applicazioni più comuni. Vengono normalmente installati su strutture con altezza inferiore a 45 metri o come dispositivi intermedi su strutture più alte unicamente per la Segnalazione Ostacolo Volo notturna.

- Low Intensity Aircraft Warning Lights compliant to ICAO Type A, B and FAA L-810 regulations.

100% LED based, these devices offer a red light with a minimum intensity of 32 Cd satisfying the most common applications. Typically installed on structures below 45 meters and as intermediate devices on taller structures, Low Intensity devices are used for night marking only.

- Dispositifs de Balisage Aérien à Basse Intensité conforment aux normes OACI Type A, B et FAA L-810.

Développés avec technologie LED, ces dispositifs diffusent une lumière rouge d'une intensité minimale de 32 Cd satisfaisant les applications les plus courantes. Ils sont utilisés sur des installations d'une hauteur inférieure à 45 mètres, ou comme dispositifs intermédiaires sur des plus hautes installations pour la signalisation de nuit.

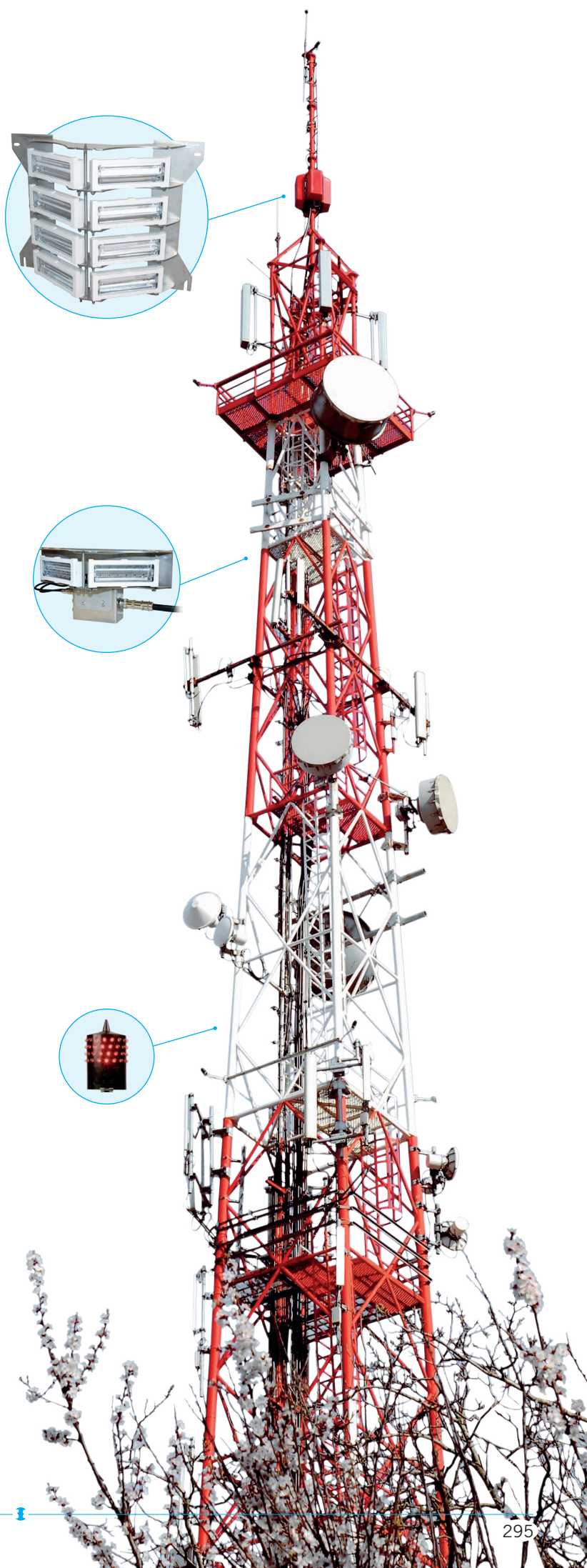

ESTRATTO TABELLA 6-3: CARATTERISTICHE SEGNALETTORI OSTACOLO VOLO
EXTRACT FROM TABLE 6-3: CHARACTERISTICS OF OBSTACLES LIGHTS
EXTRAIT DU TABLEAU 6-3 : CARACTERISTIQUES DES FEUX D'OBSTACLES

	Tipo di luce Beacon Type Type de Feu	Colore Color Couleur	Tipo di segnale (flash/min) Signal Type (flash rate) Type de signal (éclats par minute)	Intensità di picco (Cd) Peak intensity (Cd) Pic d'intensité (Cd)			Pagina Catalogo Catalogue Page Page du catalogue
				Giorno Day Jour	Crepuscolo Twilight Crépuscule	Notte Night Nuit	
Bassa Intensità Ostacoli fissi Low Intensity Fixed Obstacles Basse Intensité Obstacles fixes	Bassa Intensità, Tipo A (ostacoli fissi) Low Intensity, Type A (fixed obstacles) Basse Intensité, Type A (obstacles fixes)	rosso red rouge	Fisso Fixed Fixe	-	-	10	306
	Bassa Intensità, Tipo B (ostacoli fissi) Low Intensity, Type B (fixed obstacles) Basse Intensité, Type B (obstacles fixes)	rosso red rouge	Fisso Fixed Fixe	-	-	32	304, 305, 307
	Bassa Intensità, Tipo C (ostacoli mobili) Low Intensity, Type C (mobile obstacles) Basse Intensité, Type C (obstacles mobiles)	ambra/blu yellow/blue jaune/bleu	Lampeggiante Flashing Clignotant 60-90 fpm	-	40	40	326
Bassa Intensità Veicoli Aeroportuali Low Intensity For Airport Vehicles Basse Intensité pour Véhicules aéroportuaires	Bassa Intensità, Tipo D (veicolo follow-me) Low Intensity, Type D (follow-me vehicle) Basse Intensité, Type D (véhicule follow-me)	ambra yellow jaune	Lampeggiante Flashing Clignotant 60-90 fpm	-	200	200	327
	Media Intensità, Tipo A Medium Intensity, Type A Moyenne Intensité, Type A	bianco white blanc	Lampeggiante Flashing Clignotant 20-60 fpm	20.000	20.000	2.000	308, 309, 310, 311, 312, 313, 314, 315
	Media Intensità, Tipo B Medium Intensity, Type B Moyenne Intensité, Type B	rosso red rouge	Lampeggiante Flashing Clignotant 20-60 fpm	-	-	2.000	308, 309, 310, 311, 312, 313, 314, 315
Media Intensità, Tipo C Medium Intensity, Type C Moyenne Intensité, Type C	rosso red rouge	Fisso Fixed Fixe	-	-	2.000	308, 309, 310, 311, 312, 313, 314, 315	
Alta Intensità High Intensity Haute Intensité	Alta Intensità, Tipo A High Intensity, Type A Haute Intensité, Type A	bianco white blanc	Lampeggiante Flashing Clignotant 40-60 fpm	200.000	20.000	2.000	316

POSIZIONAMENTO LUCI SOV

La forma, la dimensione e l'altezza degli ostacoli volo (suddivisi in livelli in base all'altezza), determinano il numero di luci necessarie e la loro tipologia.

✈️ AIRCRAFT WARNING LIGHT POSITIONING

Shape, size and height of aircraft obstacles (divided into levels according to the height), determine the number of lights needed and their type.

🇮🇹 POSITIONNEMENT BALISAGE AERIEN

La forme, la dimension et la hauteur de l'obstacle vertical déterminent le nombre et le type de feux nécessaires (répartition par niveau en fonction de la hauteur).

Il numero di luci necessarie ad ogni livello dipende dal diametro della struttura:

✈️ The number of lights needed per level depends on the outside diameter of the structure being lit:

🇮🇹 Le nombre de feux nécessaires à chaque niveau dépend du diamètre de la structure :

< 6 m	= n° 3
6 - 30m	= n° 4
30 - 60m	= n° 6
> 60m	= n° 8

ICAO, Annex 14, Visual Aids 14.6.9

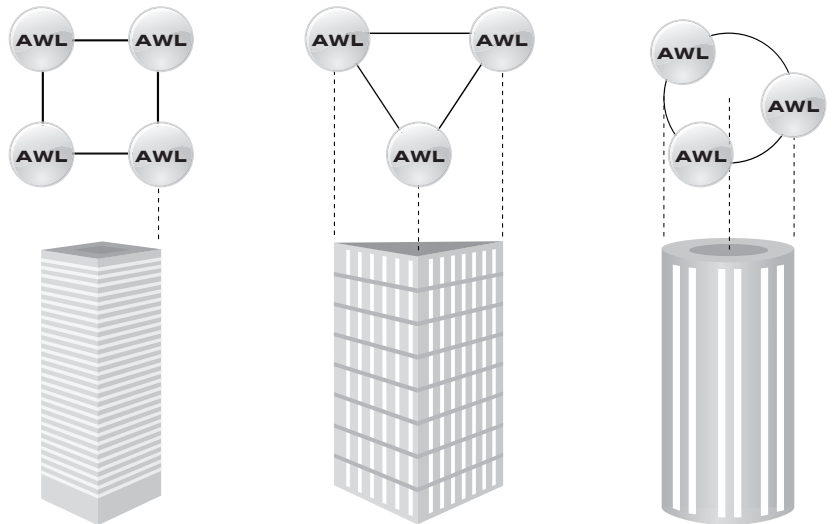

STRUTTURE ELEVATE < 45 m

ELEVATED STRUCTURES
HAUTEUR STRUCTURE

GIORNO: SPENTA - NOTTE: ROSSA FISSA
DAY: OFF - NIGHT: STEADY RED
JOUR : ETEINTE - NUIT : ROUGE FIXE

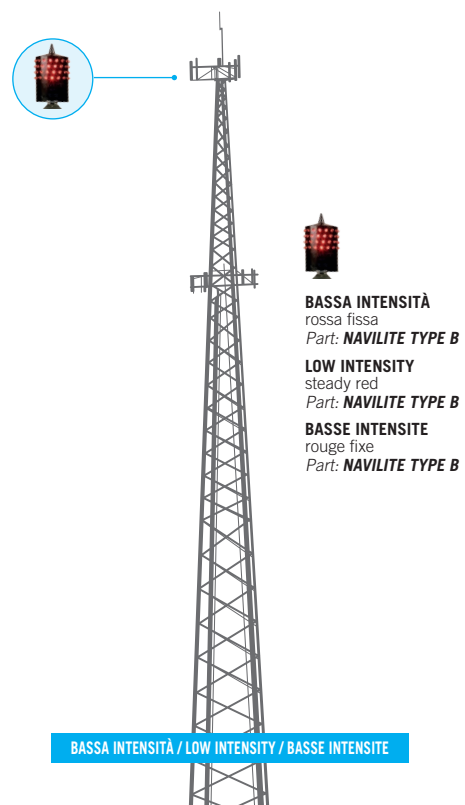

GIORNO: BIANCA LAMPEGGIANTE - NOTTE: BIANCA LAMPEGGIANTE
DAY: FLASHING WHITE - NIGHT: FLASHING WHITE
JOUR : BLANC CLIGNOTANT - NUIT : BLANC CLIGNOTANT

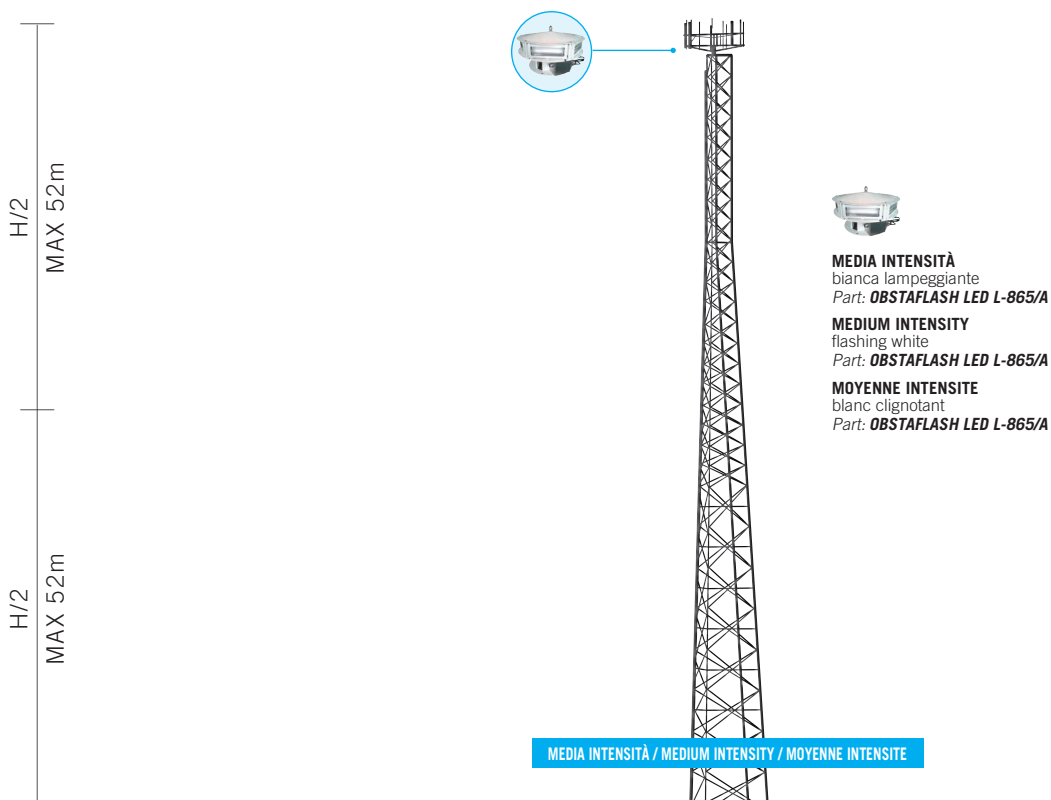

GIORNO: BIANCA LAMPEGGIANTE - NOTTE: ROSSA LAMPEGGIANTE
DAY: FLASHING WHITE - NIGHT: FLASHING RED
JOUR : BLANC CLIGNOTANT - NUIT : ROUGE CLIGNOTANT

GIORNO: BIANCA LAMPEGGIANTE - NOTTE: ROSSA FISSA
DAY: FLASHING WHITE - NIGHT: STEADY RED
JOUR : BLANC CLIGNOTANT - NUIT : ROUGE FIXE

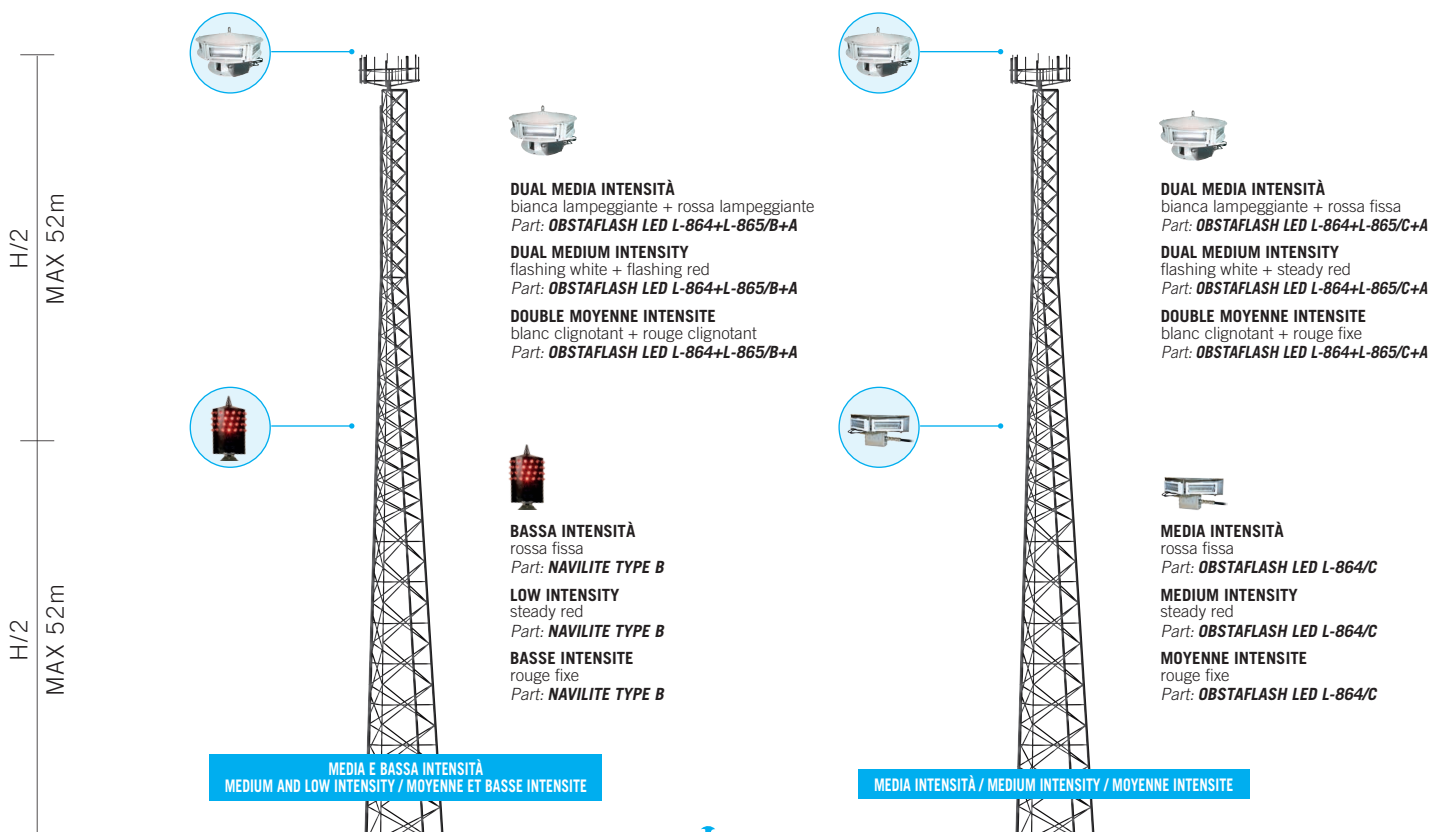

GIORNO: SPENTA - NOTTE: ROSSA LAMPEGGIANTE
DAY: OFF - NIGHT: FLASHING RED
JOUR : ETEINTE - NUIT : ROUGE CLIGNOTANT

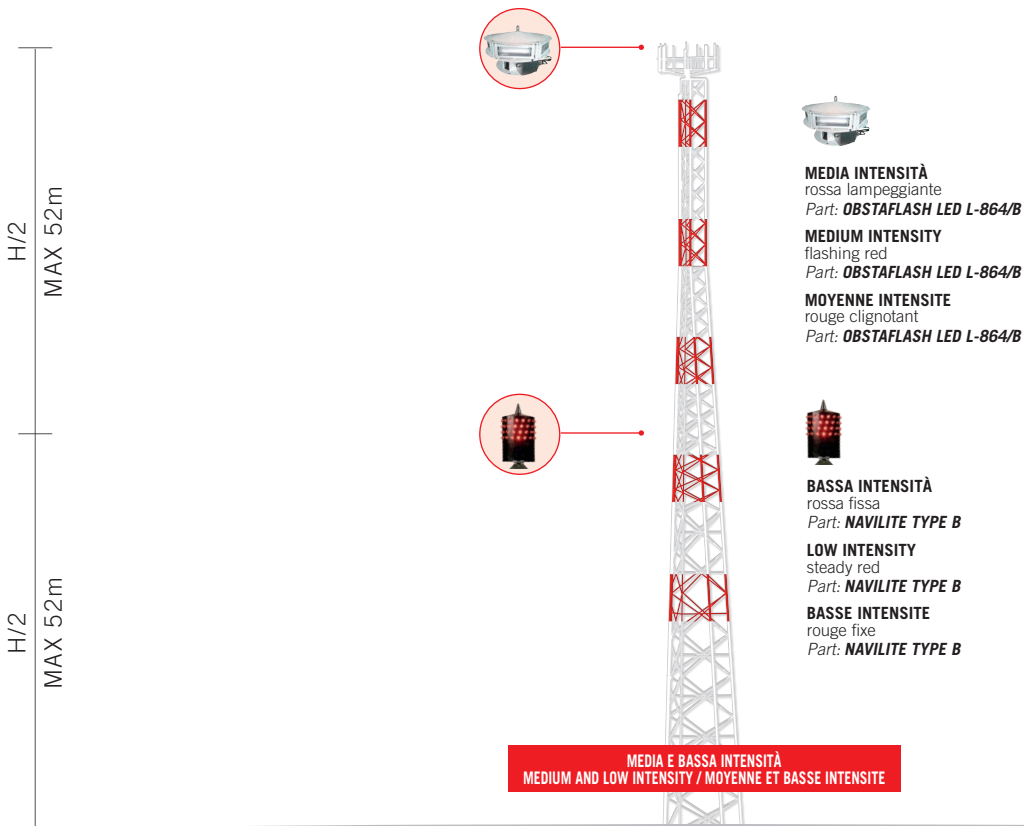

GIORNO: SPENTA - NOTTE: ROSSA FISSA
DAY: OFF - NIGHT: STEADY RED
JOUR : ETEINTE - NUIT : ROUGE FIXE

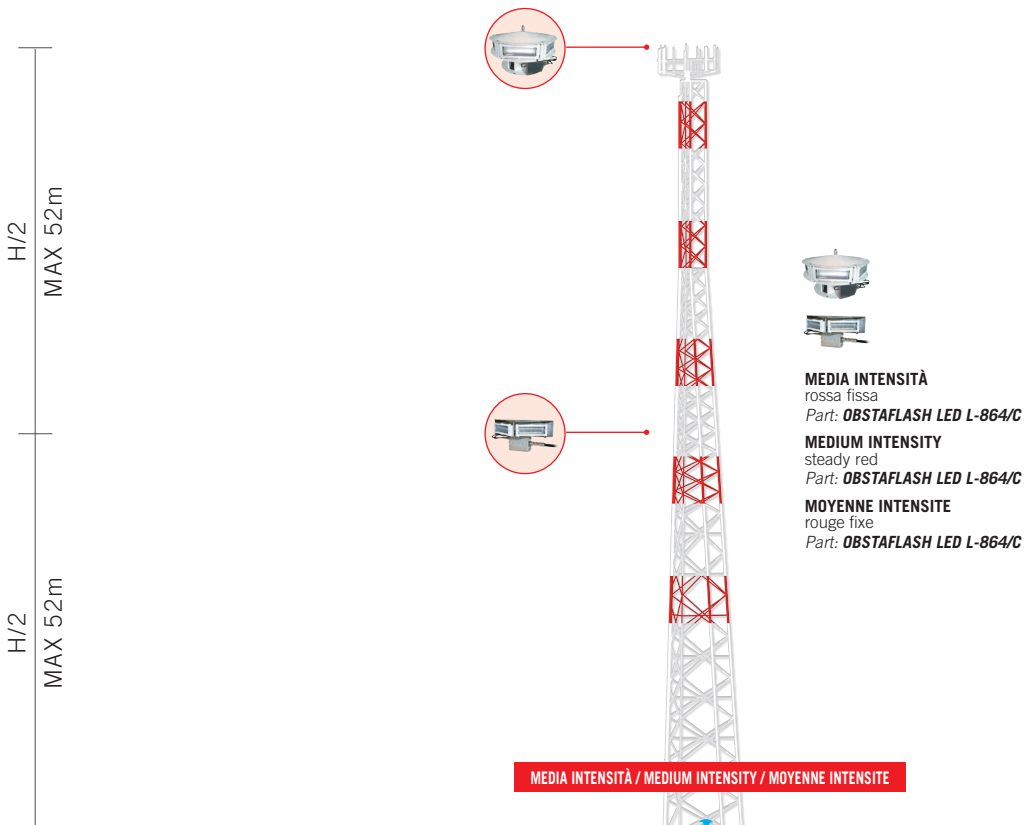

GIORNO: BIANCA LAMPEGGIANTE - NOTTE: BIANCA LAMPEGGIANTE
DAY: FLASHING WHITE - NIGHT: FLASHING WHITE
JOUR : BLANC CLIGNOTANT - NUIT : BLANC CLIGNOTANT

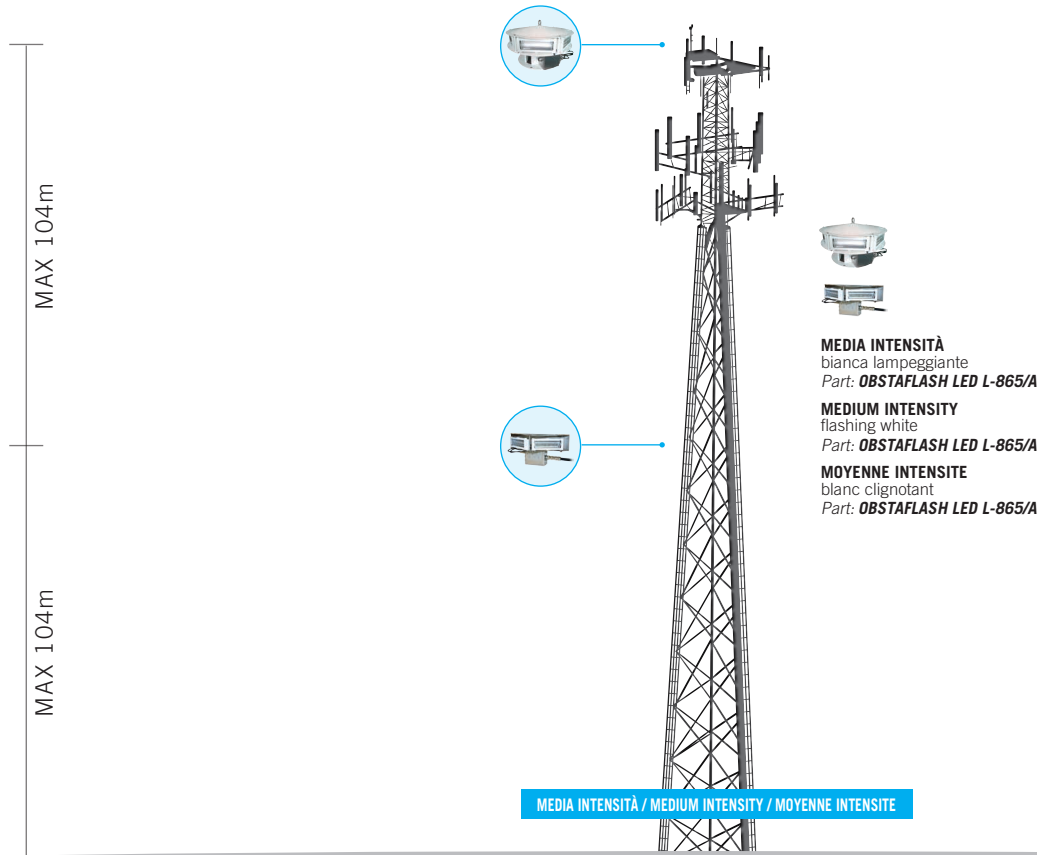

GIORNO: BIANCA LAMPEGGIANTE - NOTTE: ROSSA LAMPEGGIANTE
DAY: FLASHING WHITE - NIGHT: FLASHING RED
JOUR : BLANC CLIGNOTANT - NUIT : ROUGE CLIGNOTANT

GIORNO: BIANCA LAMPEGGIANTE - NOTTE: ROSSA FISSA
DAY: FLASHING WHITE - NIGHT: STEADY RED
JOUR : BLANC CLIGNOTANT - NUIT : ROUGE FIXE

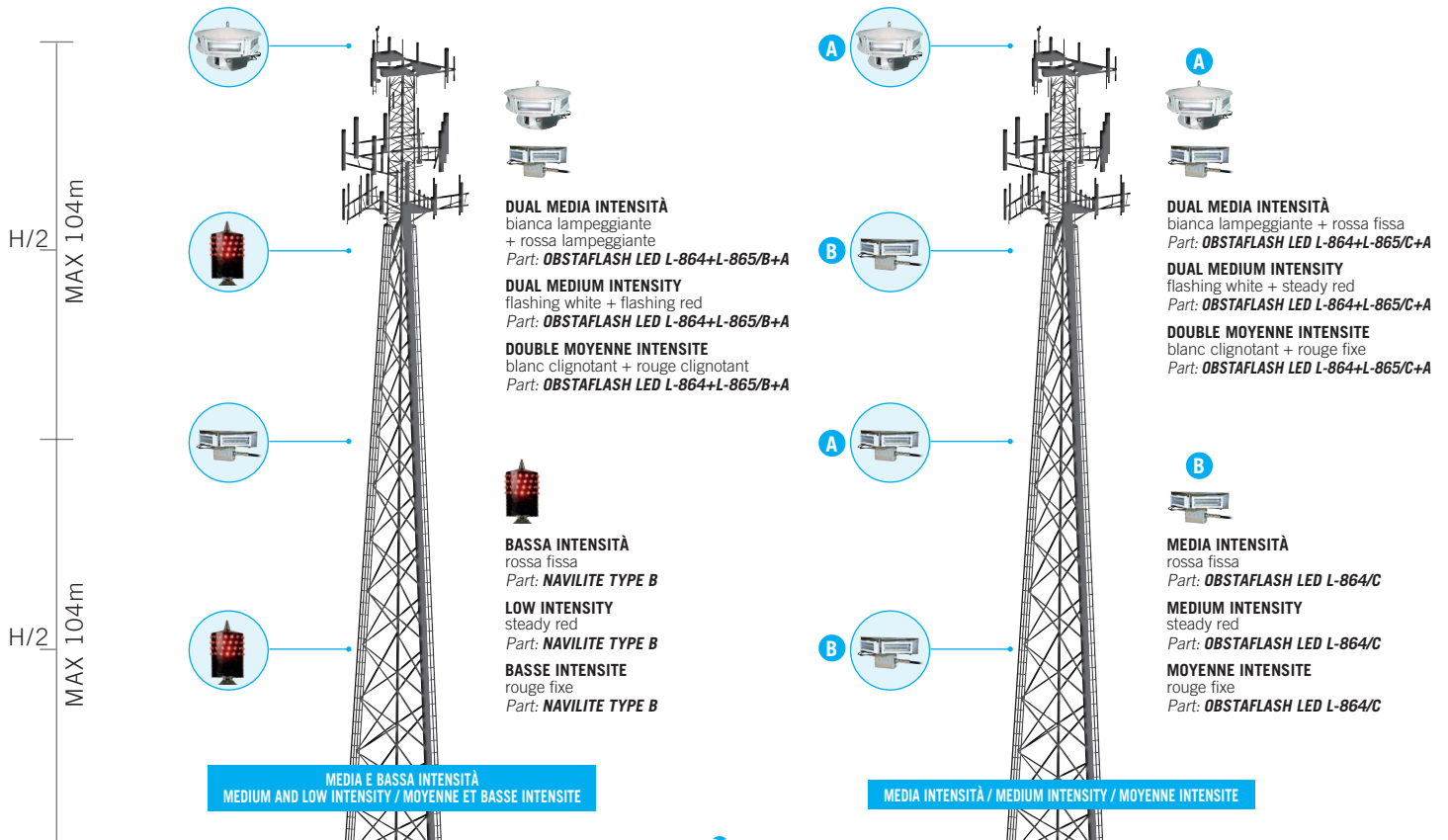

GIORNO: SPENTA - NOTTE: ROSSA LAMPEGGIANTE
DAY: OFF - NIGHT: FLASHING RED
JOUR : ETEINTE - NUIT : ROUGE CLIGNOTANT

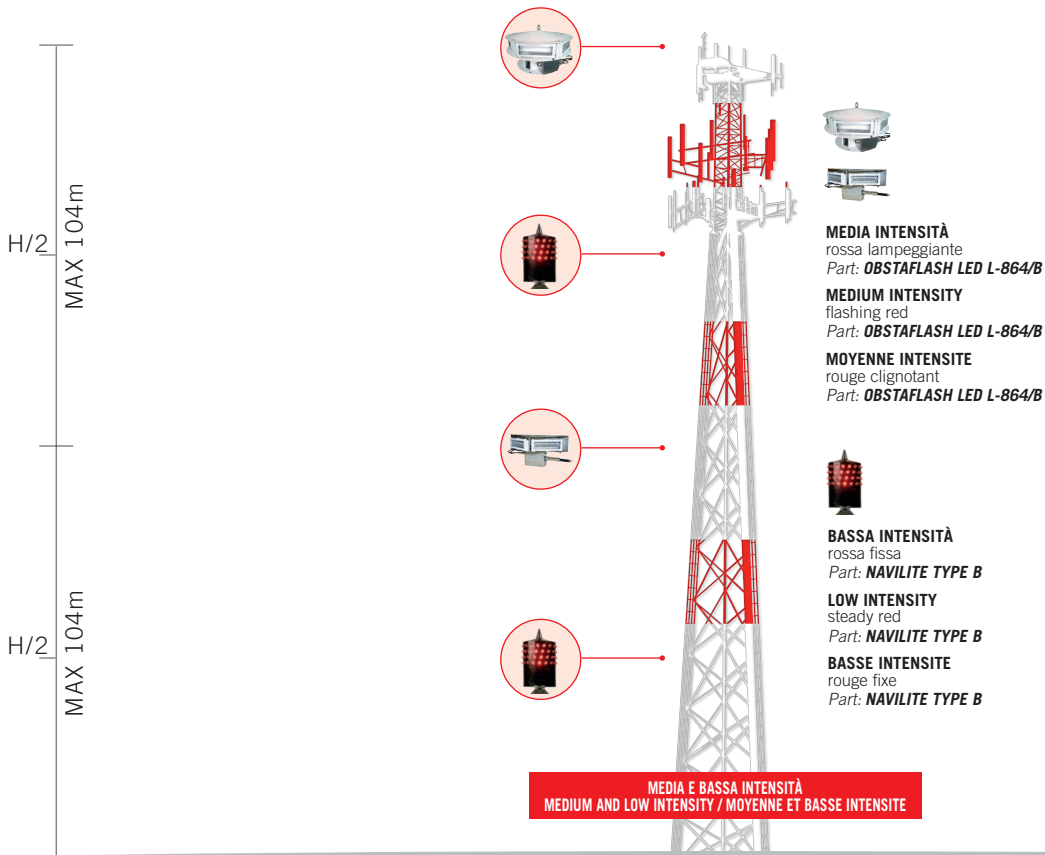

GIORNO: SPENTA - NOTTE: ROSSA FISSA
DAY: OFF - NIGHT: STEADY RED
JOUR : ETEINTE - NUIT : ROUGE FIXE

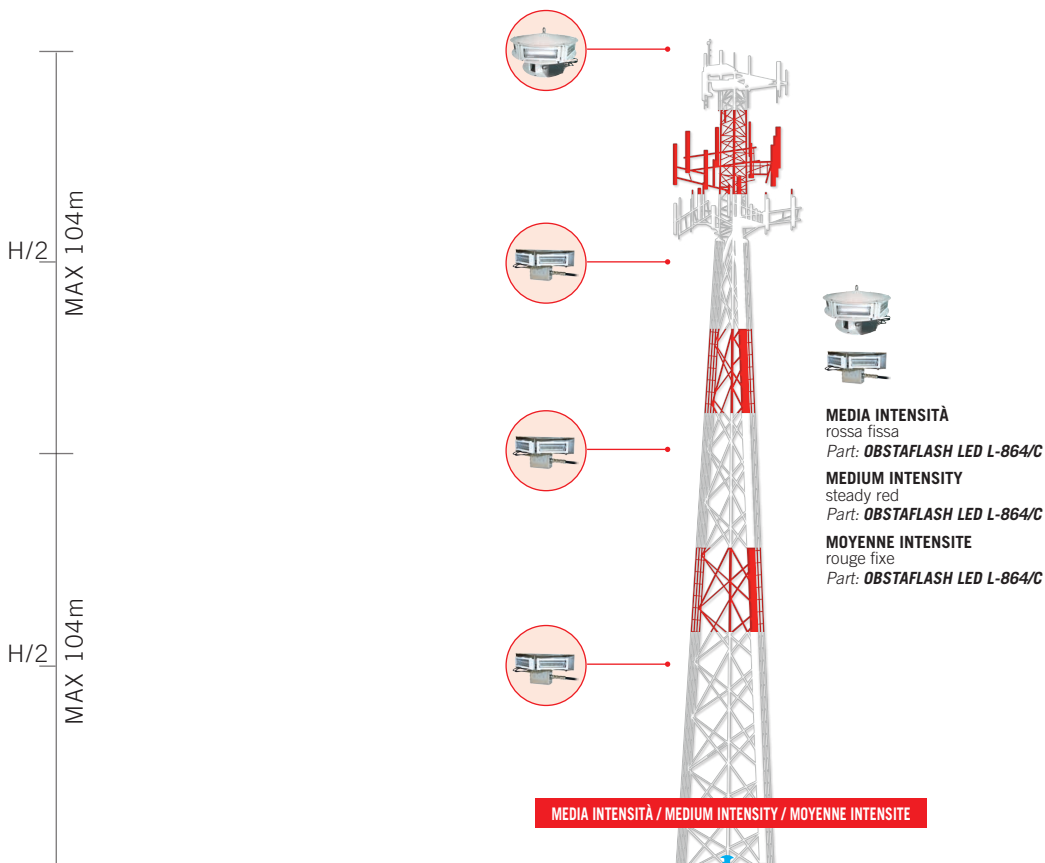

GIORNO: BIANCA LAMPEGGIANTE - NOTTE: BIANCA LAMPEGGIANTE
DAY: FLASHING WHITE - NIGHT: FLASHING WHITE
JOUR : BLANC CLIGNOTANT - NUIT : BLANC CLIGNOTANT

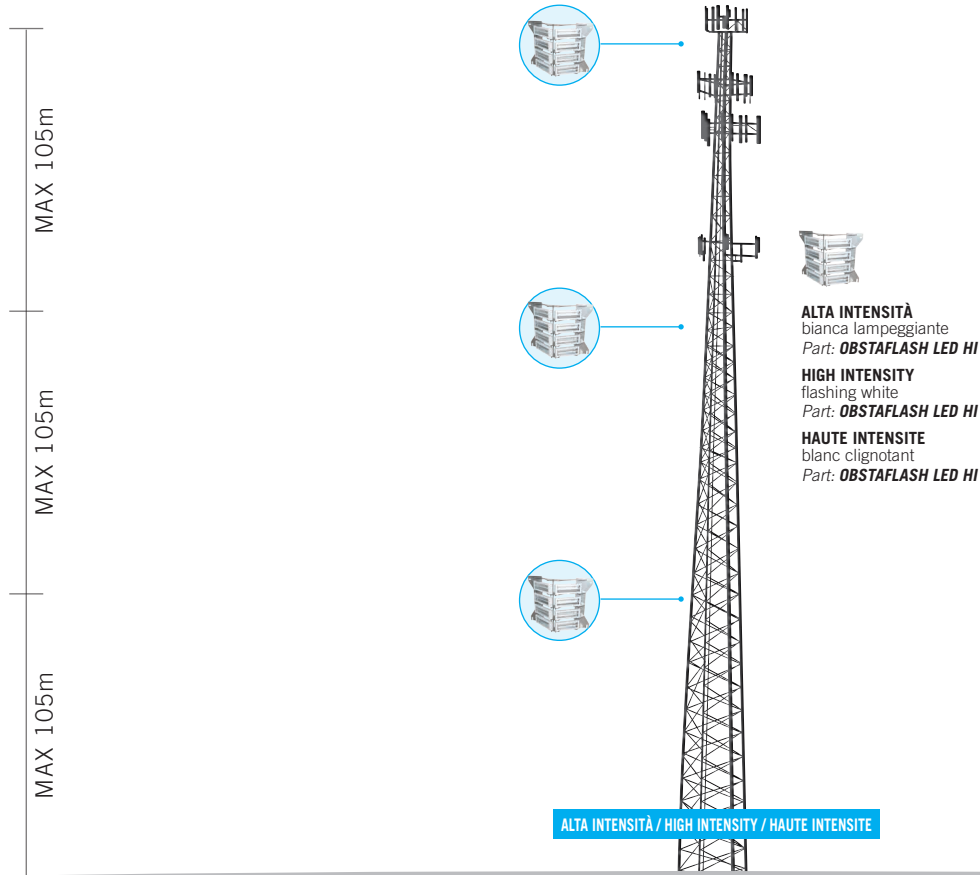

GIORNO: BIANCA LAMPEGGIANTE - NOTTE: ROSSA FISSA
DAY: FLASHING WHITE - NIGHT: STEADY RED
JOUR : BLANC CLIGNOTANT - NUIT : ROUGE FIXE

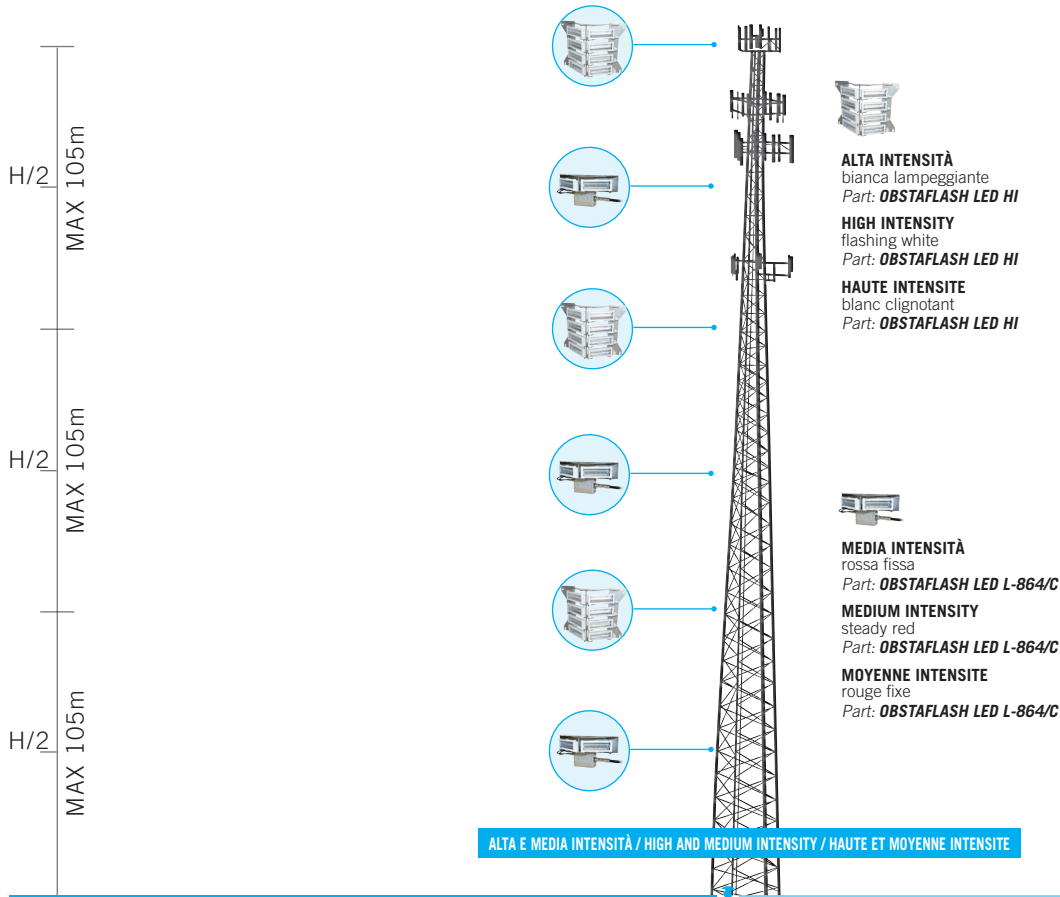

GIORNO: BIANCA LAMPEGGIANTE - NOTTE: BIANCA LAMPEGGIANTE
DAY: FLASHING WHITE - NIGHT: FLASHING WHITE
JOUR : BLANC CLIGNOTANT - NUIT : BLANC CLIGNOTANT

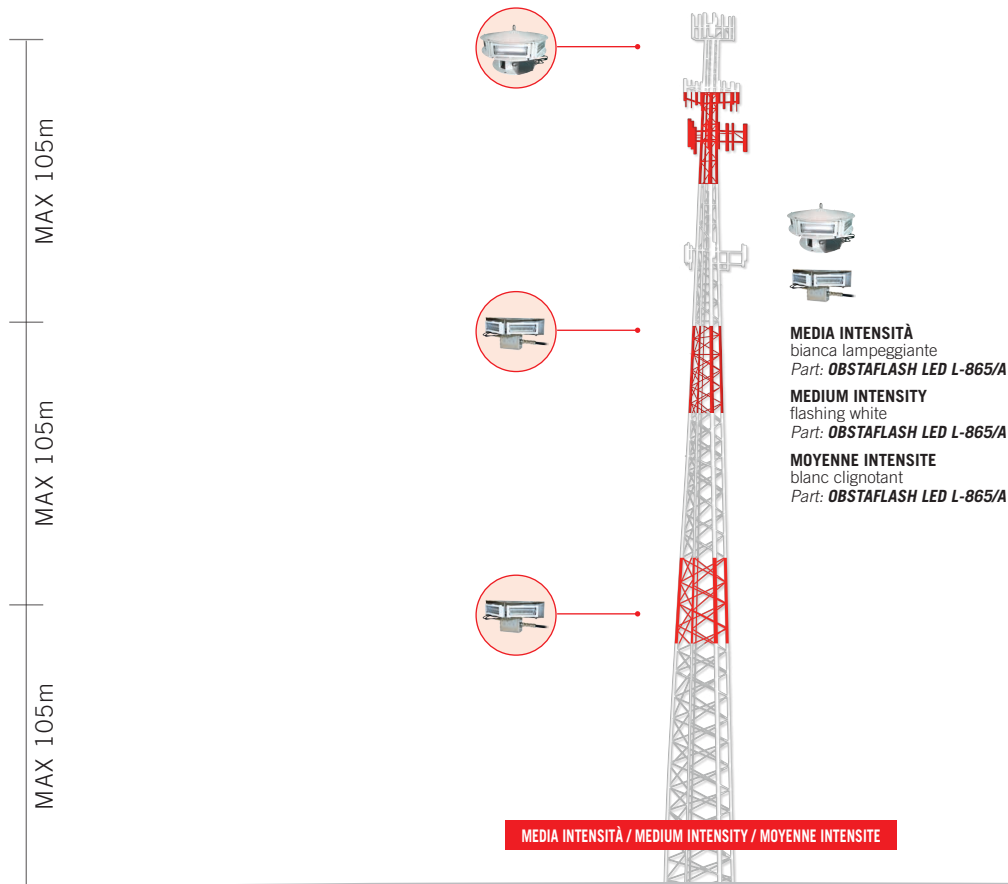

GIORNO: BIANCA LAMPEGGIANTE - NOTTE: ROSSA LAMPEGGIANTE
DAY: FLASHING WHITE - NIGHT: FLASHING RED
JOUR : BLANC CLIGNOTANT - NUIT : ROUGE CLIGNOTANT

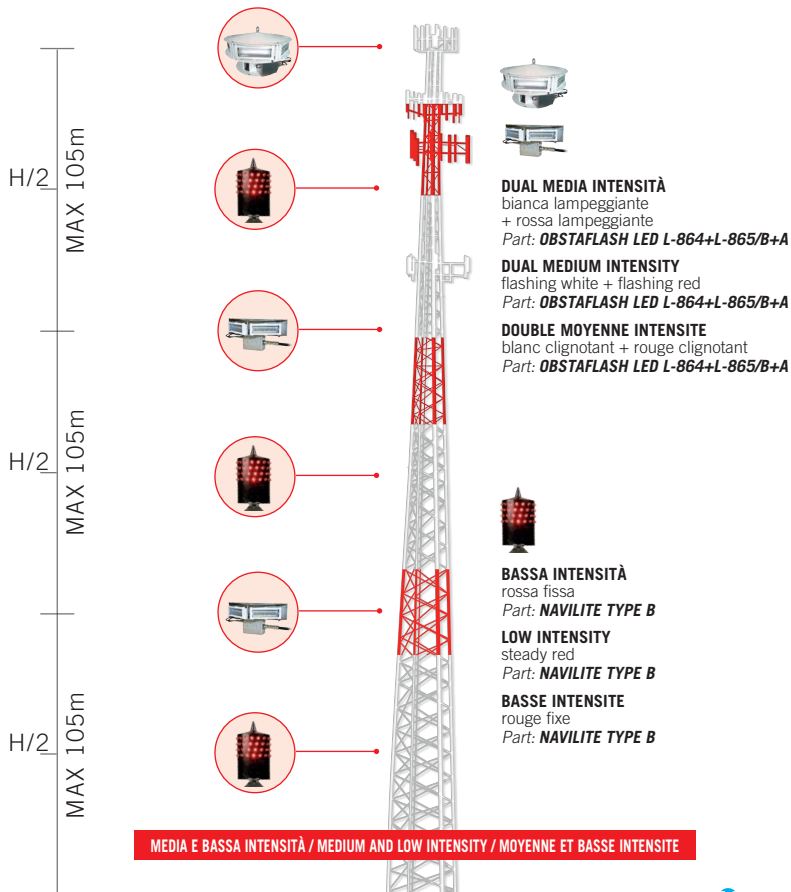

GIORNO: BIANCA LAMPEGGIANTE - NOTTE: ROSSA FISSA
DAY: FLASHING WHITE - NIGHT: STEADY RED
JOUR : BLANC CLIGNOTANT - NUIT : ROUGE FIXE

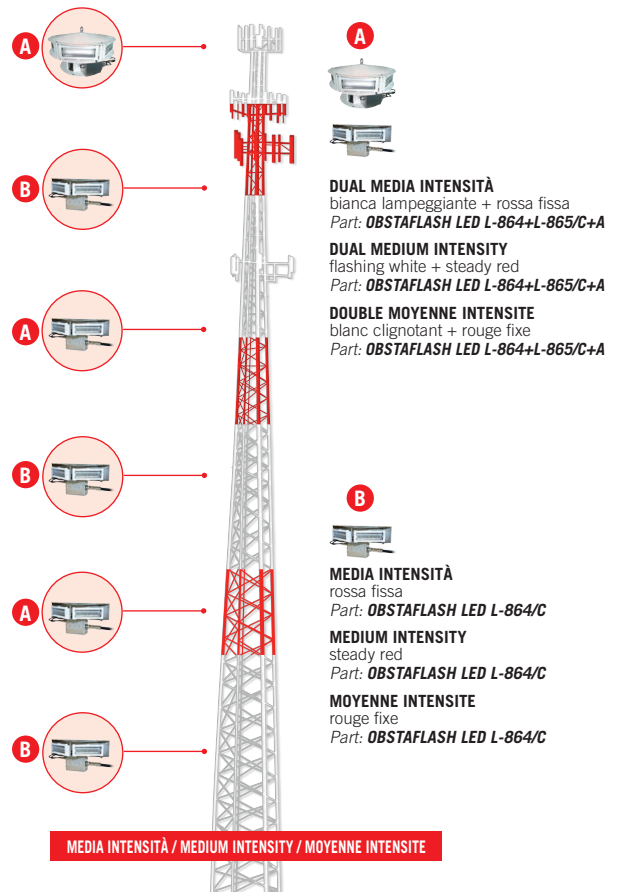

NAVILITE



NAVILITE TYPE B



APPLICAZIONI PRINCIPALI / TYPICAL APPLICATIONS APPLICATIONS PRINCIPALES

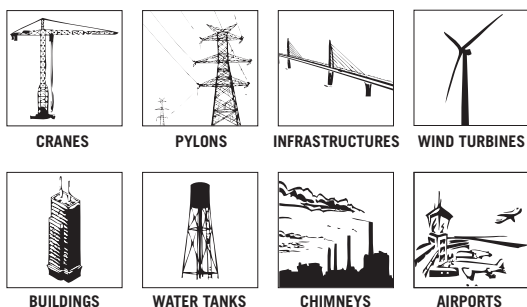

ACCESSORI / ACCESSORIES / ACCESSOIRES



Codici / Codes

NAVILITE TYPE B 24V DC R 50501
NAVILITE TYPE B 48V DC R 50500

ACCESSORI / ACCESSORIES / ACCESSOIRES

NAVILITE FIXING BRACKET 50505
NAVILITE D/N COMMAND BOX 48V DC 50506

BATTERY CABINET for:

- 1 NAVILITE 48V 2,1Ah 50546
- 2 / 3 NAVILITE 48V 4,5Ah 50547
- 4 NAVILITE 48V 7Ah 50548
- 8 NAVILITE 48V 12Ah 50549
- 16 NAVILITE 48V 24Ah 50550

Segnalatore Ostacolo Volo a Bassa Intensità progettato secondo la normativa ICAO Bassa Intensità Tipo B.

NAVILITE è dotato di luce rossa fissa con fascio luminoso orizzontale omnidirezionale. 64 LED, montati in ridondanza su 16 circuiti indipendenti da 4 LED, garantiscono la continuità di funzionamento del dispositivo anche in caso di guasto di uno o più circuiti. Questa soluzione rende superfluo l'utilizzo di luci con circuito di back-up. La tecnologia a LED garantisce inoltre la lunga vita del prodotto (oltre 10 anni) ed il basso consumo del dispositivo (1/10 rispetto alle versioni tradizionali ad incandescenza). Fornito con cavo da 35 cm.

Il **COMMAND BOX** (50506) permette il cablaggio e il monitoraggio di 1 o 2 NAVILITE 48V DC per il funzionamento notturno o continuo. Con più segnalatori, è possibile farli funzionare simultaneamente o in ridondanza (una luce primaria e una secondaria che si attiva nel caso in cui la primaria non funzioni) con segnalazione remota in caso di guasto della luce o mancanza della tensione 48V DC. Sensore crepuscolare integrato.

Tensione operativa

24V DC, 48V DC +/-10%

Alimentazione opzionale tramite **BATTERY CABINET** (solo per 48V DC) con autonomia di 12 ore.

Caratteristiche meccaniche

Corpo segnalatore in resina di Poliuretano dielettrico

Caratteristiche luminose

Colore rosso fisso

Intensità luminosa >32Cd

Larghezza del fascio orizzontale 360°

Larghezza del fascio verticale >10°

Fissaggio

Tramite una vite M5

ACCESSORIO installazione

- staffa di fissaggio **FIXING BRACKET** in acciaio inox (50505)

Certificazioni / Certifications



ICAO International Standards and Recommended Practices:
Aerodromes - Annex 14 Volume 1, 4th Edition, November 2004
Chapter 6

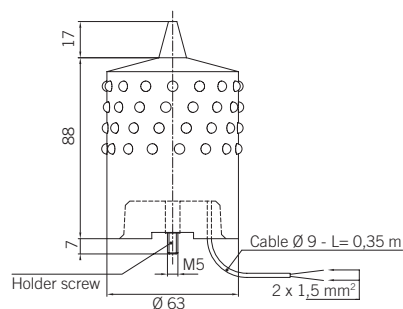

NAVILITE TYPE B



Low Intensity Aircraft Warning Light engineered according to ICAO Low Intensity Type B regulation.

NAVILITE is provided with a red steady light covering 360° horizontal beam. 64 LEDs, wired in active redundancy (16 independent circuits of 4 LEDs), guarantee marking continuity even when one or more circuits fail. This solution makes the use of warning lights with back-up circuit superfluous. The LED technology guarantees a long product life estimated in over 10 years, as well as low consumption (1/10 when compared to incandescent bulbs). Supplied with cable 35 cm.

The **COMMAND BOX** (50506) allows wiring and monitoring of 1 or 2 NAVILITE 48V DC working at night only or continuously. It allows simultaneously or in redundancy operation (a main and a back-up light, the latter automatically switches when main fails) with remote signalization in case of failure of the light or of the 48V DC supply. Integrated photocell.

Voltages

24V DC, 48V DC +/-10%

Optional power supply through **BATTERY CABINET** (only for 48V DC) with 12 hours backup.

Mechanical features

Dielectric polyurethane resin body

Optical features

Red steady light | Luminous intensity >32Cd
Horizontal beam spread 360° | Vertical beam spread >10°

Fixing

- Through M5 screw. Installation accessory:
• stainless steel **FIXING BRACKET** (50505)



Feu de Balisage Aérien à Basse Intensité conforme aux normes OACI Basse Intensité Type B.

NAVILITE diffuse un faisceau lumineux rouge fixe, horizontal et omnidirectionnel. 64 leds, montées en redondance sur 16 circuits de 4 leds, le fonctionnement du dispositif est garanti même en cas de panne d'un ou plusieurs circuits. Cette fonction rend inutile l'utilisation de feux équipés de circuits back-up. La technologie LED offre une longue durée de vie au produit (au moins 10 ans) et une faible consommation (10 fois inférieure à la version traditionnelle avec ampoule à incandescence). Fourni avec câble de 35 cm.

Le **COMMAND BOX** (50506) permettant le câblage et la gestion de 1 ou 2 feux NAVILITE 48V CC en fonctionnement nocturne ou continu. Avec davantage de feux, il est possible de les faire fonctionner simultanément ou en redondance (un feu principal et un feu de secours qui s'allume en cas de panne du feu principal). En cas de panne d'un feu ou d'un problème d'alimentation, l'information est remontée et signalée. Interrupteur crépusculaire intégré, gestion automatique du mode jour/nuit.

Tension d'alimentation - 24V CC, 48V CC +/-10%

Disponible en option : alimentation par batterie **BATTERY CABINET** 12h d'autonomie (pour version 48V CC exclusivement).

Caractéristiques mécaniques

Corps du feu en résine de polyuréthane diélectrique

Caractéristiques lumineuses

Couleur rouge fixe | Intensité lumineuse >32Cd
Largeur du faisceau horizontal 360°
Largeur du faisceau vertical >10°

Système de fixation - Par vis M5. Accessoire d'installation :

- Potence de fixation **FIXING BRACKET** en acier inoxydable (50505)

KIT NAVILITE D/N 230V AC



KIT NAVILITE D/N TYPE B 230V AC

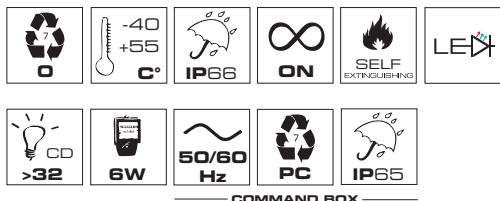

COMMAND BOX

APPLICAZIONI PRINCIPALI / TYPICAL APPLICATIONS APPLICATIONS PRINCIPALES

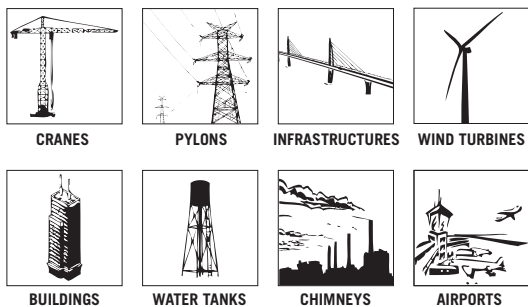

ACCESSORI E RICAMBI / ACCESSORIES AND SPARE PARTS ACCESSOIRES ET RECHANGES

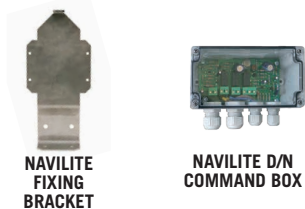

Codici / Codes

KIT NAVILITE D/N TYPE B 230V AC R ● 50503

ACCESSORI E RICAMBI / ACCESSORIES AND SPARE PARTS ACCESSOIRES ET RECHANGES

NAVILITE FIXING BRACKET 50505
NAVILITE D/N COMMAND BOX 230V AC 50507

Segnalatore Ostacolo Volo a Bassa Intensità progettato secondo la normativa ICAO Bassa Intensità Tipo B.

NAVILITE è dotato di luce rossa fissa con fascio luminoso orizzontale omnidirezionale. 64 LED, montati in ridondanza su 16 circuiti indipendenti da 4 LED, garantiscono la continuità di funzionamento del dispositivo anche in caso di guasto di uno o più circuiti. Questa soluzione rende superfluo l'utilizzo di luci con circuito di back-up. La tecnologia a LED garantisce inoltre la lunga vita del prodotto (oltre 10 anni) ed il basso consumo del dispositivo (1/10 rispetto alle versioni tradizionali ad incandescenza). Dotato di **COMMAND BOX** (50507) che permette il cablaggio e il monitoraggio fino a 4 NAVILITE 48V DC per il funzionamento notturno o continuo. Con più segnalatori, è possibile farli funzionare simultaneamente o in ridondanza (una luce primaria e una secondaria che si attiva nel caso in cui la primaria non funzioni) con segnalazione remota in caso di guasto della luce o mancanza della tensione. Sensore crepuscolare integrato per commutazione D/N (giorno/notte).

Tensione operativa

230V AC +/-10% (tramite **COMMAND BOX** fissato sulla staffa di montaggio)

Caratteristiche meccaniche

Corpo segnalatore in resina di Poliuretano dielettrico
Corpo **COMMAND BOX** in policarbonato, IP65 (in posizione verticale)

Caratteristiche luminose

Colore rosso fisso | Intensità luminosa >32Cd
Larghezza del fascio orizzontale 360° | Larghezza del fascio verticale >10°

Fissaggio

Tramite una vite M5
• staffa di fissaggio **FIXING BRACKET** in acciaio inox fornita

Certificazioni / Certifications



ICAO International Standards and Recommended Practices:
Aerodromes - Annex 14 Volume 1, 4th Edition, November 2004
Chapter 6

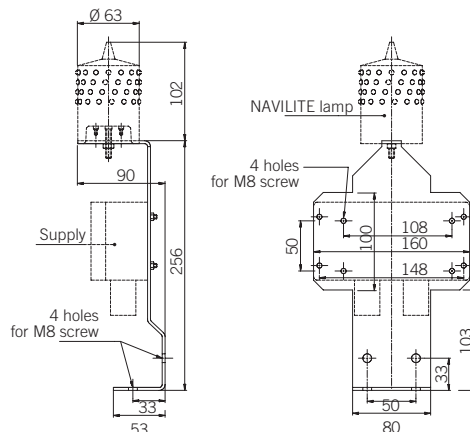

KIT NAVILITE D/N
TYPE B 230V AC



Low Intensity Aircraft Warning Light engineered according to ICAO Low Intensity Type B regulation.

NAVILITE is provided with a red steady light covering 360° horizontal beam. 64 LEDs, wired in active redundancy (16 independent circuits of 4 LEDs), guarantee marking continuity even when one or more circuits fail. This solution makes the use of warning lights with back-up circuit superfluous. The LED technology guarantees a long product life estimated in over 10 years, as well as low consumption (1/10 when compared to incandescent bulbs). Provided with **COMMAND BOX** (50507) that allows wiring and monitoring up to 4 NAVILITE 48V DC working at night only or continuously. It allows simultaneously or in redundancy operation (a main and a back-up light, the latter automatically switches when main fails) with remote signalization in case of failure of the light or of the 48V DC supply. Integrated photocell for D/N (day/night) switching.

Voltages

230V AC +/-10% (through **COMMAND BOX** mounted on fixing bracket)

Mechanical features

Warning light: Dielectric polyurethane resin body
COMMAND BOX IP 65 (vertical position): polycarbonate body

Optical features

Red steady light
Luminous intensity >32Cd
Horizontal beam spread 360°
Vertical beam spread >10°

Fixing - Through M5 screw

• stainless steel **FIXING BRACKET** (50505) provided



Feu de Balisage Aérien Basse Intensité conforme aux normes OACI Basse Intensité Type B.

NAVILITE diffuse un faisceau lumineux rouge fixe, horizontal et omnidirectionnel. 64 leds, montées en redondance sur 16 circuits de 4 leds, le fonctionnement du dispositif est garanti même en cas de panne d'un ou plusieurs circuits. Cette fonction rend inutile l'utilisation de feux équipés de circuits back-up. La technologie LED offre une longue durée de vie au produit (au moins 10 ans) et une faible consommation (10 fois inférieure à la version traditionnelle avec ampoule à incandescence). Fourni avec son **COMMAND BOX** (50507) permettant le câblage et la gestion jusqu'à 4 feux NAVILITE 48V CC en fonctionnement nocturne ou continu. Avec avantage de feu, il est possible de les faire fonctionner simultanément ou en redondance (un feu principal et un feu de secours qui s'allume en cas de panne du feu principal). En cas de panne d'un feu ou d'un problème d'alimentation, l'information est remontée et signalée. Interrupteur crépusculaire intégré, gestion automatique du mode jour/nuit.

Tension d'alimentation - 230V CA +/-10% (alimenté à travers le **COMMAND BOX** fixé sur la potence de fixation)

Caractéristiques mécaniques - Corps du feu en résine de polyuréthane diélectrique
Corps **COMMAND BOX** en polycarbonate, IP65 (en position verticale)

Caractéristiques lumineuses - Couleur : rouge fixe
Intensité lumineuse >32Cd
Largeur du faisceau horizontal 360°
Largeur du faisceau vertical >10°

Système de fixation - Par vis M5

Accessoire d'installation :
• potence de fixation **FIXING BRACKET** en acier inoxydable

SOLAR NAVILITE



SOLAR NAVILITE TYPE A 12V DC



APPLICAZIONI PRINCIPALI / TYPICAL APPLICATIONS APPLICATIONS PRINCIPALES

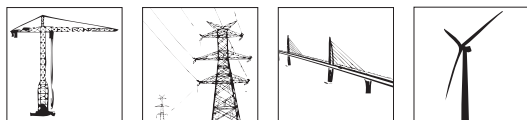

CRANES

PYLONS

INFRASTRUCTURES

WIND TURBINES



BUILDINGS

WATER TANKS

CHIMNEYS

AIRPORTS

ACCESSORI / ACCESSORIES / ACCESSOIRES



NAVILITE
FIXING
BRACKET



12V SOLAR KIT
20-25WP*

Codici / Codes

SOLAR NAVILITE TYPE A 12V DC R  50502

ACCESSORI / ACCESSORIES / ACCESSOIRES

NAVILITE FIXING BRACKET 50505

* I SOLAR KIT sono configurati e dimensionati in base al numero dei segnalatori previsti dal progetto e all'area geografica in cui verranno installati.

* Size and configuration of SOLAR KIT depend on the number of warning lights required from the project and their location

* Les SOLAR KIT sont configurés et dimensionnés en fonction du nombre de feux prévus dans l'application et la zone géographique dans laquelle ils seront installés.

Segnalatore Ostacolo Volo a Bassa Intensità progettato secondo la normativa ICAO Bassa Intensità Tipo A.

SOLAR NAVILITE è un dispositivo a Bassa Intensità luminosa >10Cd ideato per essere alimentato attraverso un SOLAR KIT, configurato e dimensionato in base al numero dei segnalatori previsti dal progetto e all'area geografica in cui verranno installati.

SOLAR NAVILITE è dotato di luce rossa fissa con fascio luminoso orizzontale omnidirezionale. 64 LED montati in ridondanza su 16 circuiti indipendenti da 4 LED garantiscono la continuità di funzionamento del dispositivo anche in caso di guasto di uno o più circuiti. Questa soluzione rende superfluo l'utilizzo di luci con circuito di back-up. La tecnologia a LED garantisce inoltre la lunga vita del prodotto (oltre 10 anni) ed il basso consumo del dispositivo (1/10 rispetto alle versioni tradizionali ad incandescenza).

Tensione operativa

12V DC +/-10%

Caratteristiche meccaniche

Corpo segnalatore in resina di Poliuretano dielettrico

Caratteristiche luminose

Colore rosso fisso

Intensità luminosa >10Cd

Larghezza del fascio orizzontale 360°

Larghezza del fascio verticale >10°

Fissaggio

Tramite una vite M5

ACCESSORIO installazione

- staffa di fissaggio **FIXING BRACKET** in acciaio inox (50505)

Certificazioni / Certifications



ICAO International Standards and Recommended Practices:
Aerodromes - Annex 14 Volume 1, 4th Edition, November 2004
Chapter 6

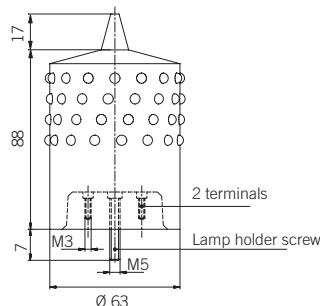

SOLAR NAVILITE TYPE A



Low Intensity Aircraft Warning Light engineered according to ICAO Low Intensity Type A regulation.

SOLAR NAVILITE is a Low Intensity >10Cd warning light powered through SOLAR KIT, configured and sized according to the number of warning lights required from the project and their location.

SOLAR NAVILITE is provided with a red steady light covering 360° horizontal beam. 64 LEDs, wired in active redundancy (16 independent circuits of 4 LEDs), guarantee marking continuity even when one or more circuits fail. This solution makes the use of warning lights with back-up circuit superfluous. The LED technology guarantees a long product life estimated in over 10 years, as well as low consumption (1/10 when compared to incandescent bulbs).

Voltages

12V DC +/-10%

Mechanical features

Dielectric polyurethane resin body

Optical features

Red steady light

Luminous intensity >10Cd

Horizontal beam spread 360°

Vertical beam spread >10°

Fixing

Through M5 screw

Installation accessory:

- stainless steel **FIXING BRACKET** (50505)



Feu de Balisage Aérien Basse Intensité conforme aux normes OACI Basse Intensité Type A.

SOLAR NAVILITE est un dispositif à Basse Intensité lumineuse >10Cd alimenté par un SOLAR KIT dont la configuration et les dimensions dépendent du nombre de feux prévus dans l'application et la zone géographique dans laquelle ils seront installés.

64 leds, montées en redondance sur 16 circuits de 4 leds, le fonctionnement du dispositif est garanti même en cas de panne d'un ou plusieurs circuits. Cette fonction rend inutile l'utilisation de feux équipés de circuits back-up. La technologie LED offre une longue durée de vie au produit (au moins 10 ans) et une faible consommation (10 fois inférieure à la version traditionnelle avec ampoule à incandescence).

Tension d'alimentation

12V CC +/-10%

Caractéristiques mécaniques

Corps du feu en résine de polyuréthane diélectrique

Caractéristiques lumineuses

Couleur rouge fixe

Intensité lumineuse >10Cd

Largueur du faisceau horizontal 360°

Largueur du faisceau vertical >10°

Système de fixation

Par vis M5

Accessoire d'installation :

- potence de fixation **FIXING BRACKET** en acier inoxydable (50505)

NAVILITE FAA L-810



NAVILITE FAA L-810

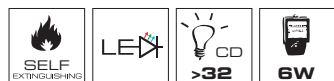
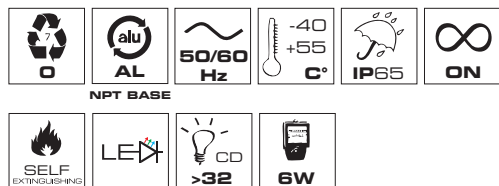

APPLICAZIONI PRINCIPALI / TYPICAL APPLICATIONS APPLICATIONS PRINCIPALES

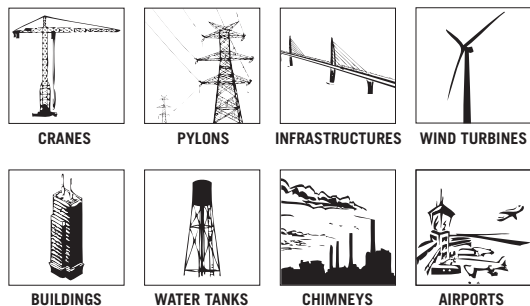

Codici / Codes

NAVILITE FAA L-810 110-240V AC R



Segnalatore Ostacolo Volo a Bassa Intensità progettato secondo la normativa ICAO Bassa Intensità Tipo B e FAA L-810.

NAVILITE FAA è dotato di luce rossa fissa con fascio luminoso orizzontale omnidirezionale. 64 LED montati in ridondanza su 16 circuiti indipendenti da 4 LED garantiscono la continuità di funzionamento del dispositivo anche in caso di guasto di uno o più circuiti. Questa soluzione rende superfluo l'utilizzo di luci con circuito di back-up. La tecnologia a LED garantisce inoltre la lunga vita del prodotto (oltre 10 anni) ed il basso consumo del dispositivo (1/10 rispetto alle versioni tradizionali ad incandescenza).

La base del dispositivo è dotata di sistema di protezione dalle sovratensioni e da contatto pulito per segnalazione remota di allarme.

Tensione operativa

110/240V AC +/-10% 50/60Hz

Caratteristiche meccaniche

Corpo segnalatore in resina di Poliuretano dielettrico
Base NPT in alluminio

Caratteristiche luminose

Colore rosso fisso
Intensità luminosa >32Cd
Larghezza del fascio orizzontale 360°
Larghezza del fascio verticale >10°

Fissaggio

2x 1" NPT fori filettati

Caratteristiche Tecniche

Convertitore di corrente AC/DC con regolatore di corrente
Protezione dalle sovratensioni 10kA in 8/20µs
Contatto pulito per segnalazione remota di allarme

Certificazioni / Certifications



ICAO International Standards and Recommended Practices:
Aerodromes - Annex 14 Volume 1, 4th Edition,
November 2004 Chapter 6
FAA Advisory Circular AC 150/5345-53

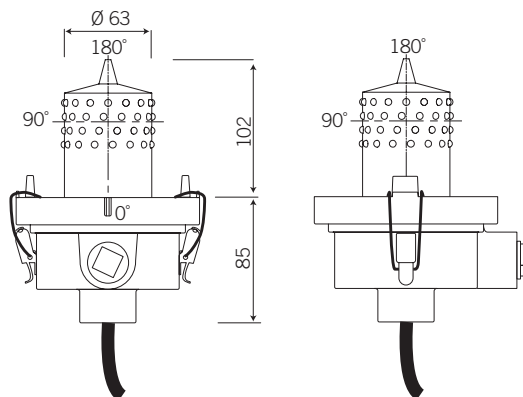

NAVILITE FAA L-810



Low Intensity Aircraft Warning Light engineered according to ICAO Low Intensity Type B and FAA L-810 regulations.

NAVILITE FAA is provided with a red steady light covering 360° horizontal beam. 64 LEDs, wired in active redundancy (16 independent circuits of 4 LEDs), guarantee marking continuity even when one or more circuits fail. This solution makes the use of warning lights with back-up circuit superfluous. The LED technology guarantees a long product life estimated in over 10 years, as well as low consumption (1/10 when compared to incandescent bulbs). The base is provided with surge protection and alarm dry contact.

Voltagges - 110/240V AC +/-10% 50/60Hz

Mechanical features

Dielectric polyurethane resin body | Aluminum NPT base

Optical features

Red steady light | Luminous intensity >32Cd
Horizontal beam spread 360°
Vertical beam spread >10°

Fixing - 2x 1" NPT threaded holes

Technical features

AC/DC converter with current regulation
Surge protection 10kA in 8/20µs
Alarm dry contact for remote signalization



Feu de Balisage Aérien Basse Intensité conforme aux normes OACI Basse Intensité Type B et FAA L-810.

NAVILITE FAA diffuse un faisceau lumineux rouge fixe, horizontal et omnidirectionnel. 64 leds, montées en redondance sur 16 circuits de 4 leds, le fonctionnement du dispositif est garanti même en cas de panne d'un ou plusieurs circuits. Cette fonction rend inutile l'utilisation de feux équipés de circuits back-up. La technologie LED offre une longue durée de vie au produit (au moins 10 ans) et une faible consommation (10 fois inférieure à la version traditionnelle avec ampoule à incandescence). La base du dispositif est équipée d'un système de protection contre les surtensions et d'un relais d'alarme.

Tension d'alimentation - 110/240V CA +/-10% 50/60Hz

Caractéristiques mécaniques

Corps du feu en résine de polyuréthane diélectrique
Base NPT en aluminium

Caractéristiques lumineuses

Couleur rouge fixe | Intensité lumineuse >32Cd
Largeur du faisceau horizontal 360°
Largeur du faisceau vertical >10°

Système de fixation - 2x 1" NPT trous filetés

Caractéristiques techniques

Convertisseur de courant CA/CC avec régulateur de courant
Protection contre les surtensions 10kA en 8/20µs
Contact sec pour le relai d'alarme

OBSTAFLASH LED



OBSTAFLASH LED L-864/B
OBSTAFLASH LED L-864/C
OBSTAFLASH LED L-865/A
OBSTAFLASH LED L-864+L-865/B+A
OBSTAFLASH LED L-864+L-865/C+A

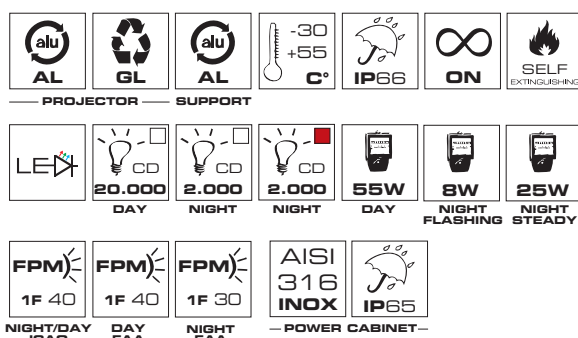

APPLICAZIONI PRINCIPALI / TYPICAL APPLICATIONS APPLICATIONS PRINCIPALES

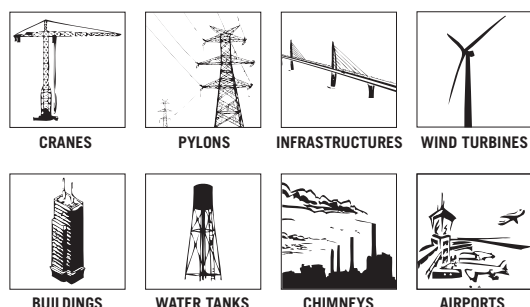

ACCESSORI / ACCESSORIES / ACCESSOIRES

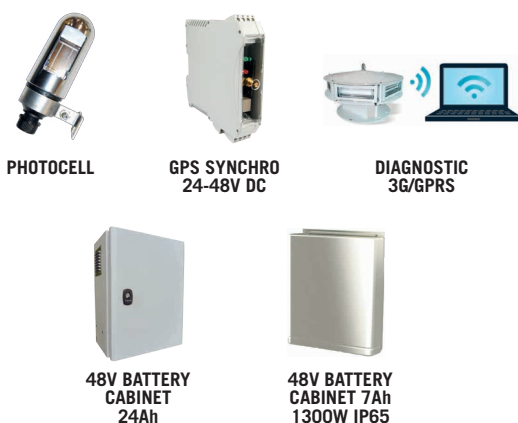

Segnalatore Ostacolo Volo a Media Intensità progettato secondo la normativa ICAO Media Intensità Tipo A, B, C, B+A, C+A e FAA L-864, L-865.

OBSTAFLASH LED è composto da 6 proiettori a LED indipendenti, alimentati a 48V DC e pilotati da un **POWER CABINET** in acciaio inox. In dotazione connettore dedicato per cablaggio sul segnalatore.

Il dispositivo è progettato per gestire circuiti indipendenti a led che, in caso di guasto di uno di questi, garantisce la segnalazione a 360° e la copertura in candele prevista dalla norma con segnalazione remota nel box di comando.

OBSTAFLASH LED, disponibile nelle versioni con luce rossa lampeggiante (50510-50514), rossa fissa (50509-50515), con luce bianca lampeggiante (50508-50513), bianca e rossa lampeggiante (50511-50516), bianca lampeggiante e rossa fissa (50512-50517), è la soluzione ideale per la segnalazione diurna e/o notturna di qualsiasi ostacolo volo la cui altezza superi i 45m.

Per gli ostacoli di altezza inferiore ai 150 metri l'uso di luce dual color o bianca L-865 / L-864 durante il giorno non rende necessario dipingere l'ostacolo con strisce bianche e rosse.

Il segnalatore deve essere utilizzato con fotocellula esterna (vedi pagina accessori), collegata al **POWER CABINET** e orientata verso il Nord (nell'emisfero Nord).

Tensione operativa

48V DC, 110/240V AC (50/60Hz) +/-10% tramite **POWER CABINET**

Per versioni 48V DC, alimentazione opzionale tramite **BATTERY CABINET** (50549-50550) con autonomia di 12 ore, oppure tramite **BATTERY CABINET** in Inox IP65 da 7Ah 1300W (50551), maggiori info alla pagina accessori.

Caratteristiche meccaniche

Corpo proiettore in alluminio e vetro

Supporto verticale in alluminio

POWER CABINET: acciaio inox AISI 316L

Caratteristiche luminose

Larghezza del fascio orizzontale 360°

Larghezza del fascio verticale >3°

Fissaggio

Tramite supporto verticale in alluminio con 6 fori di fissaggio Ø 16 mm sulla circonferenza (Ø 337 mm)

Caratteristiche Tecniche

POWER CABINET

- Sicurezza: interruzione automatica della tensione all'apertura del box di alimentazione
- Protezione sovratensione inclusa
- Segnalazione di allarme tramite contatto pulito NC (chiuso) o NO (aperto) in caso di malfunzionamento dei segnalatori o mancanza di alimentazione
- Commutatore di test con modalità remoto (fotocellula) / giorno / notte
- Sincronizzazione master/slave di più **POWER CABINET** tramite cavo blindato 3G1,5
- 8 Indicatori a led per una facile diagnostica
- Possibilità di collegare luci intermedie a Bassa Intensità Tipo B (**NAVILITE** 48V DC) per il funzionamento notturno
- Contatto per integrazione crepuscolare

Accessori

Fotocellula crepuscolo/notte in conformità ICAO e FAA (maggiori info alla pagina accessori)

Modulo **GPS SYNCHRO** per la sincronizzazione di impianti separati secondo norma ICAO e FAA (maggiori info alla pagina accessori)

KIT DIAGNOSTIC GPRS per il monitoraggio a distanza dello stato dei segnalatori, delle batterie e della presenza rete (maggiori info alla pagina accessori)

Certificazioni / Certifications



ICAO International Standards and Recommended Practices:
Aerodromes - Annex 14 Volume 1, 4th Edition,
November 2004 Chapter 6
FAA Advisory Circular AC 150/5345-33

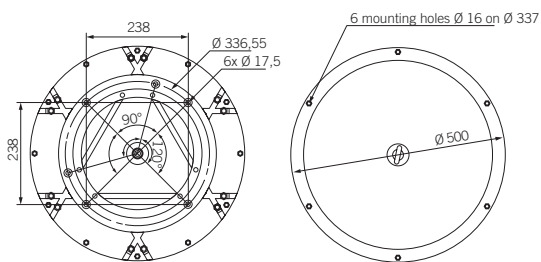

OBSTAFASH LED 48V DC

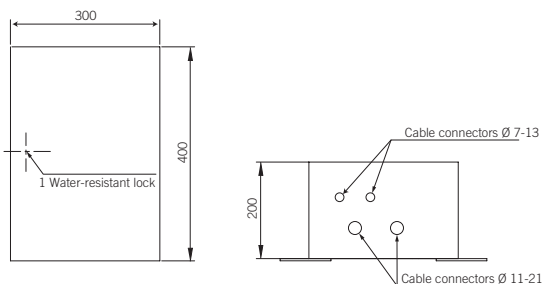

POWER CABINET



Codici / Codes

- OBSTAFASH LED L-864/B 48V DC R 50510
- OBSTAFASH LED L-864/C 48V DC R 50509
- OBSTAFASH LED L-865/A 48V DC W 50508
- OBSTAFASH LED L-864+L-865/B+A 48V DC RW 50511
- OBSTAFASH LED L-864+L-865/C+A 48V DC RW 50512

- OBSTAFASH LED L-864/B 110/240V AC R 50514
- OBSTAFASH LED L-864/C 110/240V AC R 50515
- OBSTAFASH LED L-865/A 110/240V AC W 50513
- OBSTAFASH LED L-864+L-865/B+A 110/240V AC RW 50516
- OBSTAFASH LED L-864+L-865/C+A 110/240V AC RW 50517

ACCESSORI E RICAMBI / ACCESSORIES AND SPARE PARTS
ACCESSOIRES ET RECHANGES

- OBSTAFASH POWER CARD 50536
- PHOTOCELL
In base alla tensione di alimentazione
According to voltage / Selon la tension d'alimentation
- SYNCHRO GPS 24-48V DC 50538
- DIAGNOSTIC 3G/GPRS 50539
- BATTERY CABINET 7Ah 1300W IP65 50551
- BATTERY CABINET 48V DC 12Ah (20 flashes) 50549
- BATTERY CABINET 48V DC 24Ah (40 flashes) 50550



Medium Intensity Aircraft Warning Light engineered according to ICAO Medium Intensity Type A, B, C, B+A, C+A and FAA L-864, L-865 regulations.

OBSTAFASH LED is provided with 6 independent LED projectors 48V DC, powered by a stainless steel POWER CABINET. Wiring connector on the flash head included.

The device is designed with independent LED circuits that in case of failure of one of these allow 360° signalization and Cd requirements according to the norm. Remote alarm indication in the command box.

OBSTAFASH LED is available in the following LED versions: with red flashing light (50510-50514), red steady light (50509-50515), white flashing light (50508-50513), dual color flashing light (50511-50516), white flashing light and red steady (50512-50517). OBSTAFASH LED is the ideal solution for day and/or night marking of all kind of obstacle higher than 45 meters. For obstacles below 150 meters the use of white or dual color L-865/L-864 during daytime obviates the need to paint the obstacle with red and white stripes.

OBSTAFASH LED shall be used with an external photocell (see accessories section), connected to the POWER CABINET and oriented to the North (in the North Hemisphere).

Voltages

48V DC, 110/240V AC 50/60Hz +/-10% through POWER CABINET

For 48V DC versions, optional power supply through BATTERY CABINET (50549-50550), 12 hours backup or through stainless steel IP65 7Ah 1300W BATTERY CABINET (50551), for further information see accessories section.

Mechanical features

Aluminum and glass projector body
Aluminum vertical support
POWER CABINET: AISI 316L stainless steel

Optical features

Horizontal beam spread 360°
Vertical beam spread >3°

Fixing

Through aluminum vertical support with 6 Ø 16 mm mounting holes on the circumference Ø 337 mm.

Technical features

- POWER CABINET
- Safety alarm closing contact
- Surge protection
- NC and NO alarm dry contact in case of failure of the light or of the power supply
- Test button with three positions: remote (photocell) / day / night
- Master/slave configuration in case of use of more POWER CABINET through shielded cable 3G1,5
- 8 luminous LED indicators for an easy diagnostic
- Possibility to connect intermediate Low Intensity Type B (NAVILITE 48V DC) lights for night operation only
- Integrated photocell switch

Accessories

Twilight/night photocell according to ICAO and FAA norms (see accessories section)

GPS SYNCHRO interface for synchronisation of separate installations according to ICAO and FAA norms (see accessories section)

KIT DIAGNOSTIC GPRS allows remote diagnostic of lights and their power supply or of the batteries (see accessories section)



Feu de Balisage Aérien Moyenne Intensité conforme aux normes OACI Moyenne Intensité Type A, B, C, B+A, C+A et FAA L-864, L-865.

OBSTAFASH LED est composé de 6 projecteurs à LED indépendants, alimentation 48V CC, pilotés depuis un POWER CABINET en acier inoxydable. Fourni avec les connecteurs pour le câblage des feux.

Le dispositif est développé de façon à garantir une signalisation à 360° et un niveau de luminosité toujours conforme à celui prévu dans les normes OACI même en cas de panne d'un des circuits. Relais d'alarme dans l'armoire de commande.

OBSTAFASH LED, disponible en version à lumière rouge clignotante (50510-50514), rouge fixe (50509-50515), lumière blanche clignotante (50508-50513), lumière rouge et blanche clignotante (50511-50516), blanche clignotante et rouge fixe (50512 et 50517), c'est la solution idéale pour le balisage diurne et/ou nocturne d'un obstacle vertical d'une hauteur supérieure à 45 mètres.

Pour les obstacles d'une hauteur inférieure à 150 mètres, l'utilisation de lumières bicolores ou blanches L-865/L-864 pendant le jour rend facultative la peinture rouge et blanche de l'obstacle.

Le feu doit être utilisé avec une photocellule externe (voir page accessoires), connectée à l'armoire d'alimentation et orientée vers le Nord (dans l'hémisphère Nord).

Tension d'alimentation

48V CC, 110/240V CA (50/60Hz) +/-10% par l'armoire d'alimentation POWER CABINET

Pour la version 48V CC, option d'alimentation disponible : BATTERY CABINET (50549-50550) autonomie 12h, et BATTERY CABINET en inox IP65 autonomie 7h 1300W (50551), informations complémentaires à la page des accessoires

Caractéristiques mécaniques

Corps des projecteurs en aluminium et verre
Support vertical en aluminium
POWER CABINET : acier inoxydable AISI 316L

Caractéristiques lumineuses

Largeur du faisceau horizontal 360°
Largeur du faisceau vertical >3°

Système de fixation

Support vertical en aluminium avec 6 points de fixation (Ø 16 mm) sur la circonférence (Ø 337 mm).

Caractéristiques techniques

- POWER CABINET
- Sécurité : interruption automatique de l'alimentation à l'ouverture de l'armoire d'alimentation
- Protection contre les surtensions
- Renvoi d'alarme par contact sec, NC (fermé) ou NO (ouvert) en cas de dysfonctionnement des feux ou d'un manque d'alimentation.
- Bouton de test jour/nuit
- Synchronisation maître/esclave des armoires à travers un câble 3G1,5
- 8 indicateurs LED pour un diagnostic simple de l'état du système
- Possibilité de connecter des feux Basse Intensité Type B (NAVILITE 48V CC) intermédiaires pour application nocturne.
- Contact pour interrupteur crépusculaire

Accessoires

Photocellule crépuscule/nuit conforme aux normes OACI et FAA (informations complémentaires page accessoires)

Module GPS SYNCHRO pour synchronisation des installations distantes selon les normes OACI et FAA (informations complémentaires page accessoires)

KIT DIAGNOSTIC GPRS pour contrôle à distance de l'état des feux, des batteries et de la présence de réseau (informations complémentaires page accessoires)

KIT OBSTAFLASH 120° 48V DC



KIT OBSTAFLASH 3x120 L-864/B 48V DC
 KIT OBSTAFLASH 3x120 L-864/C 48V DC
 KIT OBSTAFLASH 3x120 L-865/A 48V DC
 KIT OBSTAFLASH 3x120 L-864+L-865/B+A 48V DC
 KIT OBSTAFLASH 3x120 L-864+L-865/C+A 48V DC

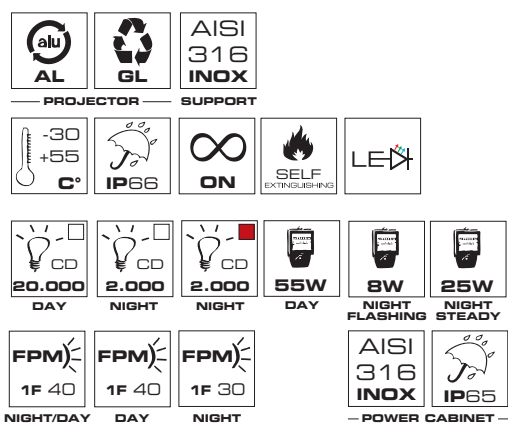

APPLICAZIONI PRINCIPALI / TYPICAL APPLICATIONS APPLICATIONS PRINCIPALES

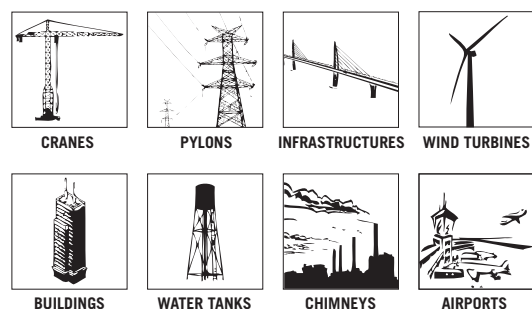

ACCESSORI / ACCESSORIES / ACCESSOIRES



Segnalatore Ostacolo Volo a Media Intensità progettato secondo la normativa ICAO Media Intensità Tipo A, B, C, B+A, C+A e FAA L-864, L-865.

Il **KIT OBSTAFLASH 120°** è composto da 3 segnalatori a Media Intensità progettati per la segnalazione diurna e/o notturna di ostacoli volo (ciminiere, piloni, tralici, etc...) e da un **POWER CABINET 48V DC**.

Affinché un ostacolo sia visibile sui 360° occorre prevedere almeno 3 segnalatori disposti a 120° sulla sua circonferenza. Nel caso in cui il diametro dell'ostacolo superi i 6 m, occorre utilizzare 4 segnalatori* su ogni livello, disposti a 90° sulla circonferenza.

Ciascun segnalatore è composto da 2 proiettori a LED con 2 circuiti in ridondanza.

Il KIT è disponibile con Led di colore rosso fisso (50519) e lampeggiante (50518) per la segnalazione notturna, bianco lampeggiante per la segnalazione diurna/crepuscolare (50520)¹ o bicolore rosso/bianco lampeggiante (50521)¹, rosso fisso/bianco lampeggiante (50522)¹.

Il segnalatore deve essere utilizzato con fotocellula esterna (vedi pagina accessori), collegata al **POWER CABINET** e orientata verso il Nord (nell'emisfero Nord).

¹ Per gli ostacoli con altezza inferiore a 150 m, l'utilizzo diurno di un segnalatore Media Intensità bianco consente l'installazione su ostacoli non marcati.

Tensione operativa

48V DC +/-10% (tramite **POWER CABINET** in acciaio inox IP65 con ingresso cavi dal basso)
 Alimentazione opzionale tramite **BATTERY CABINET** disponibili a richiesta (*maggiori info alla pagina accessori*)

Caratteristiche meccaniche

Corpo segnalatore in alluminio e vetro
 Supporto verticale in acciaio inox

Caratteristiche luminose

Larghezza del fascio orizzontale 360° con 3 segnalatori fissati a 120° intorno all'ostacolo
 Larghezza del fascio verticale >3°

Fissaggio

Tramite supporto verticale in acciaio inox

Caratteristiche Tecniche

POWER CABINET

- Sicurezza: interruzione automatica della tensione all'apertura del box di alimentazione
 - Protezione sovratensione inclusa
 - Segnalazione di allarme tramite contatto pulito NC (chiuso) o NO (aperto) in caso di malfunzionamento dei segnalatori o mancanza di alimentazione
 - Commutatore di test con modalità remoto (fotocellula) / giorno / notte
 - Sincronizzazione master/slave di più **POWER CABINET** tramite cavo blindato 3G1,5
 - 8 Indicatori a led per una facile diagnostica
 - Contatto per integrazione crepuscolare
 - Possibilità di collegare luci intermedie a Bassa Intensità Tipo B (**NAVILITE 48V DC**) per il funzionamento notturno
- POWER CABINET** con batterie di back-up disponibile a richiesta

Accessori

Fotocellula crepuscolo/notte in conformità ICAO e FAA (*maggiori info alla pagina accessori*)

Modulo **GPS SYNCRO** per la sincronizzazione di impianti separati secondo norma ICAO e FAA (*maggiori info alla pagina accessori*)

KIT DIAGNOSTIC GPRS per il monitoraggio a distanza dello stato dei segnalatori, delle batterie e della presenza rete (*maggiori info alla pagina accessori*)

Certificazioni / Certifications



ICAO International Standards and Recommended Practices:
 Aerodromes - Annex 14 Volume 1, 4th Edition,
 November 2004 Chapter 6
 FAA Advisory Circular AC 150/5345-53



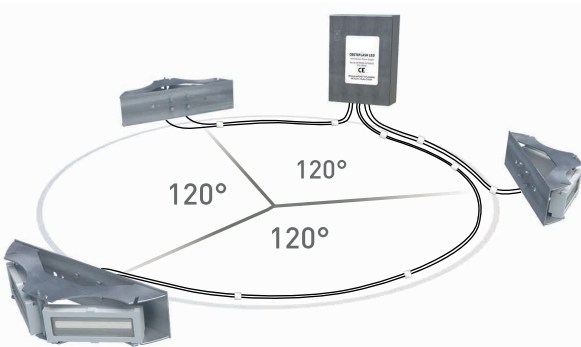

I segnalatori sono comprensivi di 3 cavi di cablaggio da 6 m (lunghezze superiori da concordare in fase d'ordine) / Beacons are supplied with 3 wiring cables of 6 m (longer lengths to be agreed when ordering) / Les feux sont fournis avec 3 fils de câblage de 6 m (longueurs supérieures à convenir lors de la commande)

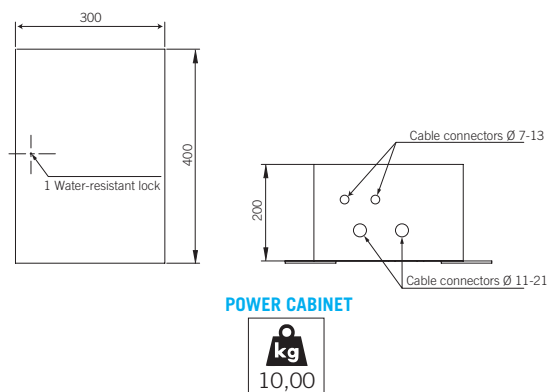
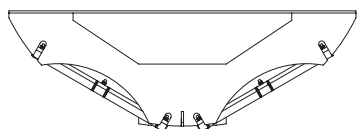
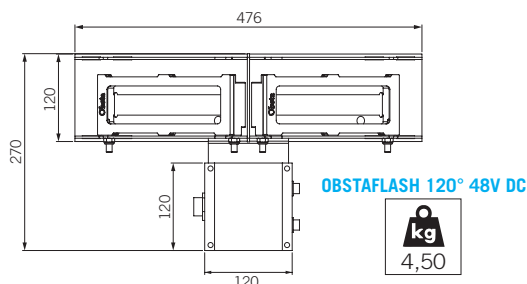

Codici / Codes

- KIT OBSTAFLASH 3X120 L-864/B 48V DC R 50518
- KIT OBSTAFLASH 3X120 L-864/C 48V DC R 50519
- KIT OBSTAFLASH 3X120 L-865/A 48V DC W 50520
- KIT OBSTAFL. 3X120 L-864+L-865/B+A 48V DC RW 50521
- KIT OBSTAFL. 3X120 L-864+L-865/C+A 48V DC RW 50522
- OBSTAFLASH 120 L-864+L-865/BC+A 48V DC RW 50537
*Segnalatore addizionale / Additional flashhead / Balise additionelle

**ACCESSORI E RICAMBI / ACCESSORIES AND SPARE PARTS
ACCESSOIRES ET RECHANGES**

- OBSTAFLASH POWER CARD 50536
- PHOTOCELL
In base alla tensione di alimentazione
According to voltage / Selon la tension d'alimentation
- SYNCHRO GPS 24-48V DC 50538
- DIAGNOSTIC 3G/GPRS 50539
- BATTERY CABINET**
- **A richiesta / On request / Sur demande



Medium Intensity Aircraft Warning Light engineered according to ICAO Medium Intensity Type A, B, C, B+A, C+A and FAA L-864, L-865 regulations.

KIT OBSTAFLASH 120° includes 3 Medium Intensity warning lights, designed for obstacles such as stacks, pylons, chimneys... and a **POWER CABINET** 48V DC.

To make an obstacle visible on 360 degrees, it is necessary to install 3 beacons distributed at 120° around the perimeter of the obstacle. For stack with diameter over 6 meters, 4 lights* per level at 90 degrees on the circumference are required. Each light is provided with 2 LED projectors with 2 circuits in redundancy.

The kit is available in the following LED versions: red steady light (50519) and red flashing light (50518) for night marking, for day marking white flashing light (50520)¹, or dual color flashing light (50521)¹; white flashing light and red steady (50522)¹.

The product shall be used with an external photocell (see accessories section), connected to the **POWER CABINET** and oriented to the North (in the North Hemisphere).

¹For obstacles below 150 meters the use of a white Medium Intensity Warning Light during daytime obviates the need to paint the obstacle with red and white stripes.

Voltages

48V DC +/-10% (through stainless steel IP65 **POWER CABINET**, cable entry from the bottom). Optional power supply through **BATTERY CABINET** (available on request), further information see accessories section

Mechanical features

Aluminum and glass projector body
Stainless steel vertical support

Optical features

Horizontal beam spread 360° with 3 warning lights distributed at 120° around the perimeter of the obstacle
Vertical beam spread >3°

Fixing

Through stainless steel vertical support

Technical features

- POWER CABINET**
- Safety alarm closing contact
- Surge protection
- NC and NO alarm dry contact in case of failure of the light or of the power supply
- Test button with three positions: remote (photocell) / day / night
- Master/slave configuration in case of use of more **POWER CABINET** through shielded cable 3G1,5
- 8 luminous LED indicators for an easy diagnostic
- Integrated photocell switch
- Possibility to connect intermediate Low Intensity Type B (**NAVILITE** 48V DC) lights for night operation only
- **POWER CABINET** with back-up batteries available on request

Accessories

Twilight/night photocell according to ICAO and FAA norms (see accessories section)

GPS SYNCRO interface for synchronisation of separate installations according to ICAO and FAA norms (see accessories section)

KIT DIAGNOSTIC GPRS allows remote diagnostic of lights and their power supply or of the batteries (see accessories section)



Feu de Balisage Aérien Moyenne Intensité conforme aux normes OACI Moyenne Intensité Type A, B, C, B+A, C+A et FAA L-864, L-865.

Le **KIT OBSTAFLASH 120°** est composé de 3 feux de Balisage Aérien à Moyenne Intensité, développés pour le balisage diurne et/ou nocturne d'obstacles verticaux (cheminées, pylônes, etc), et d'un **POWER CABINET** 48V CC. Afin que le balisage d'un obstacle soit visible à 360°, il faut prévoir l'installation d'au moins 3 feux répartis à 120° autour de l'obstacle. Dans le cas où le diamètre de l'obstacle est supérieur à 6 mètres, il faut prévoir l'installation de 4 feux* sur chaque niveau, répartis à 90° autour de l'obstacle.

Chaque feu est composé de deux projecteurs à LED avec 2 circuits en redondance.

Le **KIT** est disponible avec lumière rouge fixe (50519) et rouge clignotant (50518) pour la signalisation nocturne ; lumière blanche clignotante pour la signalisation diurne/ crépusculaire (50520)¹ ; bicolore lumière rouge/ blanche clignotante (50521)¹ ; lumière rouge fixe/blanche clignotante (50522)¹.

Le feu doit être utilisé avec une photocellule externe (voir page accessoires), connectée à l'armoire d'alimentation et orientée vers le Nord (dans l'hémisphère Nord).

¹Pour les obstacles d'une hauteur inférieure à 150 mètres, l'utilisation diurne d'un feu Moyenne Intensité blanc rend facultative la peinture en rouge et blanc de l'obstacle.

Tension d'alimentation

48V CC +/-10% (alimenté par le **POWER CABINET** en acier inoxydable IP65, entrée de câble par le dessous)

Disponible sur demande : alimentation par **BATTERY CABINET** (informations complémentaires à la page accessoires)

Caractéristiques mécaniques

Corps des projecteurs en aluminium et verre
Support vertical en acier inoxydable

Caractéristiques lumineuses

Largeur du faisceau horizontal 360° avec 3 feux répartis à 120° autour de l'obstacle
Largeur du faisceau vertical >3°

Système de fixation

Support vertical en acier inoxydable

Caractéristiques techniques

- POWER CABINET**
- Sécurité : interruption automatique de l'alimentation à l'ouverture de l'armoire d'alimentation
- Protection contre les surtensions
- Renvoi d'alarme par contact sec, NC (fermé) ou NO (ouvert) en cas de dysfonctionnement des feux ou d'un manque d'alimentation
- Bouton de test jour/nuit
- Synchronisation maître/esclave des armoires à travers un câble 3G1,5
- 8 indicateurs LED pour un diagnostic simple de l'état du système
- Possibilité de connecter des feux Basse Intensité Type B (**NAVILITE** 48V CC) intermédiaires pour application nocturne
- Batterie de secours disponible sur demande

Accessoires

Photocellule crépuscule/nuit conforme aux normes OACI et FAA (informations complémentaires page accessoires)

Module **GPS SYNCRO** pour synchronisation des installations distantes selon les normes OACI et FAA (informations complémentaires page accessoires)

KIT DIAGNOSTIC GPRS pour contrôle à distance de l'état des feux, des batteries et de la présence de réseau (informations complémentaires page accessoires)

KIT OBSTAFLASH 120° 110/240V AC



KIT OBSTAFLASH 3x120 L-864/B 110/240V AC
 KIT OBSTAFLASH 3x120 L-864/C 110/240V AC
 KIT OBSTAFLASH 3x120 L-865/A 110/240V AC
 KIT OBSTAFLASH 3x120 L-864+L-865/B+A 110/240V AC
 KIT OBSTAFLASH 3x120 L-864+L-865/C+A 110/240V AC

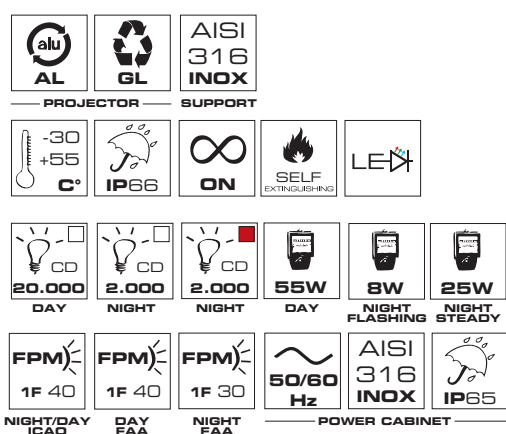

APPLICAZIONI PRINCIPALI / TYPICAL APPLICATIONS APPLICATIONS PRINCIPALES

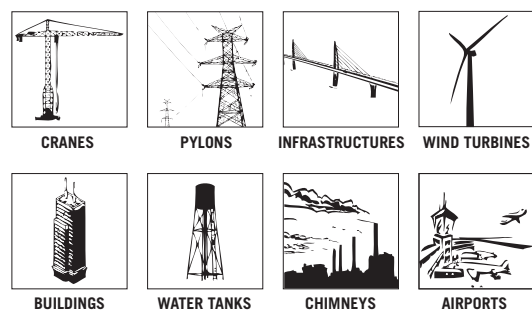

ACCESSORI / ACCESSORIES / ACCESSOIRES



Segnalatore Ostacolo Volo a Media Intensità progettato secondo la normativa ICAO Media Intensità Tipo A, B, C, B+A, C+A e FAA L-864, L-865.

Il KIT OBSTAFLASH 120° è composto da 3 segnalatori a Media Intensità progettati per la segnalazione diurna e/o notturna di ostacoli volo (ciminiere, piloni, tralicci, etc...), da un POWER CABINET 48V DC con un POWER CABINET 110/240V AC alla base dell'ostacolo. Affinché un ostacolo sia visibile sui 360° occorre prevedere almeno 3 segnalatori disposti a 120° sulla sua circonferenza. Nel caso in cui il diametro dell'ostacolo superi i 6m, occorre utilizzare 4 segnalatori* su ogni livello, disposti a 90° sulla circonferenza.

Ciascun segnalatore è composto da 2 proiettori a LED con 2 circuiti in ridondanza. Il KIT è disponibile con Led di colore rosso fisso (50523) e lampeggiante (50524) per la segnalazione notturna, bianco lampeggiante per la segnalazione diurna/crepuscolare (50525)¹ o bicolore rosso/bianco lampeggiante (50526)¹, rosso fisso/bianco lampeggiante (50527)¹.

Il segnalatore deve essere utilizzato con fotocellula esterna (vedi pagina accessori), collegata al POWER CABINET e orientata verso il Nord (nell'emisfero Nord).

¹Per gli ostacoli con altezza inferiore a 150 m, l'utilizzo diurno di un segnalatore Media Intensità bianco consente l'installazione su ostacoli non marcati.

Tensione operativa

110/240V AC (50/60Hz) +/-10% tramite POWER CABINET (alla base dell'ostacolo) in acciaio inox IP65 con ingresso cavi dal basso

Caratteristiche meccaniche

Corpo segnalatore in alluminio e vetro
 Supporto verticale in acciaio inox

Caratteristiche luminose

Larghezza del fascio orizzontale 360° con 3 segnalatori fissati a 120° intorno all'ostacolo
 Larghezza del fascio verticale >3°

Fissaggio

Tramite supporto verticale in acciaio inox

Caratteristiche Tecniche

POWER CABINET

- Sicurezza: interruzione automatica della tensione all'apertura del box di alimentazione
- Protezione sovratensione inclusa
- Segnalazione di allarme tramite contatto pulito NC (chiuso) o NO (aperto) in caso di malfunzionamento dei segnalatori o mancanza di alimentazione
- Commutatore di test con modalità remoto (fotocellula) / giorno / notte
- Sincronizzazione master/slave di più POWER CABINET tramite cavo blindato 3G1,5
- 8 Indicatori a led per una facile diagnostica
- Contatto per integrazione crepuscolare
- Possibilità di collegare luci intermedie a Bassa Intensità Tipo B (NAVILITE 48V DC) per il funzionamento notturno

POWER CABINET con batterie di back-up disponibile a richiesta

Accessori

Fotocellula crepuscolo/notte in conformità ICAO e FAA (maggiori info alla pagina accessori)

Modulo GPS SYNCHRO per la sincronizzazione di impianti separati secondo norma ICAO e FAA (maggiori info alla pagina accessori)

KIT DIAGNOSTIC GPRS per il monitoraggio a distanza dello stato dei segnalatori, delle batterie e della presenza rete (maggiori info alla pagina accessori)

Certificazioni / Certifications



ICAO International Standards and Recommended Practices:
 Aerodromes - Annex 14 Volume 1, 4th Edition
 November 2004 Chapter 6
 FAA Advisory Circular AC 150/5345-53

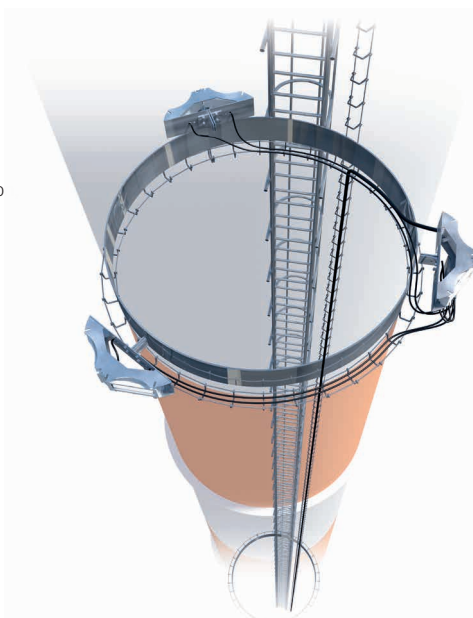



Medium Intensity Aircraft Warning Light engineered according to ICAO Medium Intensity Type A, B, C, B+A, C+A and FAA L-864, L-865 regulations.

KIT OBSTAFLASH 120° includes 3 Medium Intensity warning lights, designed for obstacles such as stacks, pylons, chimneys..., a **POWER CABINET** 48V DC and a **POWER CABINET** 110/240V AC at the bottom of the obstacle. To make an obstacle visible on 360 degrees, it is necessary to install 3 beacons distributed at 120° around the perimeter of the obstacle. For stack with diameter over 6 meters, 4 lights* per level at 90 degrees on the circumference are required. Each light is provided with 2 LED projectors with 2 circuits in redundancy. The kit is available in the following LED versions: red steady light (50523) and red flashing light (50524) for night marking, for day marking white flashing light (50525)¹, or dual color flashing light (50526)¹, white flashing light and red steady (50527)¹.

The product shall be used with an external photocell (see accessories section), connected to the **POWER CABINET** and oriented to the North (in the North Hemisphere).

¹For obstacles below 150 meters the use of white Medium Intensity Warning Light during daytime obviates the need to paint the obstacle with red and white stripes.

Voltages

110/240V AC 50/60Hz +/-10% (through stainless steel IP65 **POWER CABINET** at the bottom of the obstacle, cable entry from the bottom).

Mechanical features

Aluminum and glass projector body
Stainless steel vertical support

Optical features

Horizontal beam spread 360° with 3 warning lights distributed at 120° around the perimeter of the obstacle
Vertical beam spread >3°

Fixing

Through stainless steel vertical support

Technical features

- POWER CABINET**
- Safety alarm closing contact
 - Surge protection
 - NC and NO alarm dry contact in case of failure of the light or of the power supply
 - Test button with three positions: remote (photocell) / day / night
 - Master/slave configuration in case of use of more **POWER CABINET** through shielded cable 3G1,5
 - 8 luminous LED indicators for an easy diagnostic
 - Integrated photocell switch
 - Possibility to connect intermediate Low Intensity Type B (**NAVILITE** 48V DC) lights for night operation only
 - **POWER CABINET** with back-up batteries available on request

Accessories

Twilight/night photocell according to ICAO and FAA norms (see accessories section)

GPS SYNCHRO interface for synchronisation of separate installations according to ICAO and FAA norms (see accessories section)

KIT DIAGNOSTIC GPRS allows remote diagnostic of lights and their power supply or of the batteries (see accessories section)



Feu de Balisage Aérien Moyenne Intensité conforme aux normes OACI Moyenne Intensité Type A, B, C, B+A, C+A et FAA L-864, L-865.

Le **KIT OBSTAFLASH 120°** est composé de 3 feux de Balisage Aérien à Moyenne Intensité, développés pour le balisage diurne et/ou nocturne d'obstacles verticaux (cheminées, pylônes, etc), d'un **POWER CABINET** 48V CC + un **POWER CABINET** 110/240V CA au pied de l'obstacle.

Afin que le balisage d'un obstacle soit visible à 360°, il faut prévoir l'installation d'au moins 3 feux répartis à 120° autour de l'obstacle. Dans le cas où le diamètre de l'obstacle est supérieur à 6 mètres, il faut prévoir l'installation de 4 feux* sur chaque niveau, répartis à 90° autour de l'obstacle.

Chaque feu est composé de deux projecteurs à LED avec 2 circuits en redondance.

Le KIT est disponible avec lumière rouge fixe (50523) et rouge clignotant (50524) pour la signalisation nocturne ; lumière blanche clignotante pour la signalisation diurne/crépusculaire (50525)¹; bicolore lumière rouge/blanche clignotante (50526)¹; lumière rouge fixe/blanche clignotante (50527)¹.

Le feu doit être utilisé avec une photocellule externe (voir page accessoires), connectée à l'armoire d'alimentation et orientée vers le Nord (dans l'hémisphère Nord).

¹ Pour les obstacles d'une hauteur inférieure à 150 mètres, l'utilisation diurne d'un feu Moyenne Intensité blanc rend facultative la peinture en rouge et blanc de l'obstacle.

Tension d'alimentation

110/240V AC (50/60Hz) +/-10% par le **POWER CABINET** (au pied de l'obstacle) en acier inoxydable IP65 avec entrée de câble par le dessous.

Caractéristiques mécaniques

Corps des projecteurs en aluminium et verre
Support vertical en acier inoxydable

Caractéristiques lumineuses

Largeur du faisceau horizontal 360° avec 3 feux répartis à 120° autour de l'obstacle
Largeur du faisceau vertical >3°

Système de fixation

Support vertical en acier inoxydable

Caractéristiques techniques

- POWER CABINET**
- Sécurité : interruption automatique de l'alimentation à l'ouverture de l'armoire d'alimentation
 - Protection contre les surtensions
 - Renvoi d'alarme par contact sec, NC (fermé) ou NO (ouvert) en cas de dysfonctionnement des feux ou d'un manque d'alimentation
 - Bouton de test jour/nuit
 - Synchronisation maître/esclave des armoires à travers un câble 3G1,5
 - 8 indicateurs LED pour un diagnostic simple de l'état du système
 - Possibilité de connecter des feux Basse Intensité Type B (**NAVILITE** 48V CC) intermédiaires pour application nocturne
 - Batterie de secours disponible sur demande

Accessoires

Photocellule crépuscule/nuit conforme aux normes OACI et FAA (informations complémentaires page accessoires)

Module **GPS SYNCHRO** pour synchronisation des installations distantes selon les normes OACI et FAA (informations complémentaires page accessoires)

KIT DIAGNOSTIC GPRS pour contrôle à distance de l'état des feux, des batteries et de la présence de réseau (informations complémentaires page accessoires)

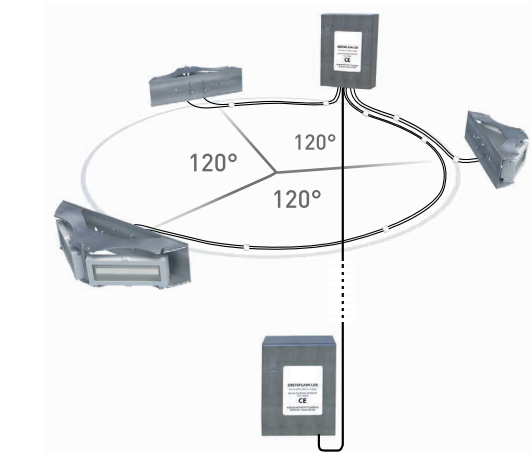

I segnalatori sono comprensivi di 3 cavi di cablaggio da 6 m (lunghezze superiori da concordare in fase d'ordine) / Beacons are supplied with 3 wiring cables of 6 m (longer lengths to be agreed when ordering) / Les feux sont fournis avec 3 fils de câblage de 6 m (longueurs supérieures à convenir lors de la commande)

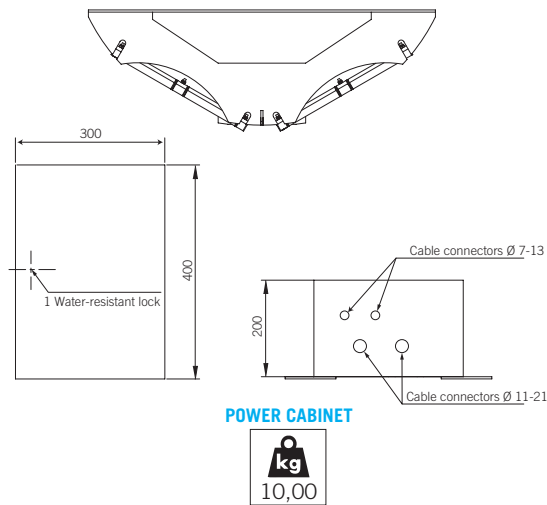
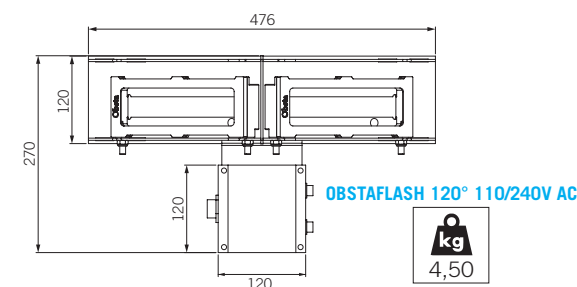

Codici / Codes

- KIT OBSTAFL. 3X120 L-864/B 110/240V AC R 50524
- KIT OBSTAFL. 3X120 L-864/C 110/240V AC R 50523
- KIT OBSTAFL. 3X120 L-865/A 110/240V AC W 50525
- KIT OBSTAFL. 3X120 L-864+L-865/B+A 110/240V AC RW 50526
- KIT OBSTAFL. 3X120 L-864+L-865/C+A 110/240V AC RW 50527
- OBSTAFL. 120 L-864+L-865/BC+A 48V DC RW 50537

*Segnalatore addizionale / Additional flashhead / Balise additionelle

**ACCESSORI E RICAMBI / ACCESSORIES AND SPARE PARTS
ACCESSOIRES ET RECHANGES**

OBSTAFLASH POWER CARD	50536
PHOTOCELL	
<i>In base alla tensione di alimentazione According to voltage / Selon la tension d'alimentation</i>	
SYNCHRO GPS 24-48V DC	50538
DIAGNOSTIC 3G/GPRS	50539

OBSTAFLASH LED 180°

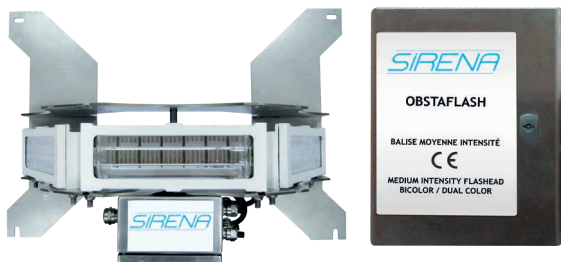

OBSTAFLASH LED 180 TYPE B
 OBSTAFLASH LED 180 TYPE C
 OBSTAFLASH LED 180 TYPE A
 OBSTAFLASH LED 180 TYPE B+A
 OBSTAFLASH LED 180 TYPE C+A
 KIT OBSTAFLASH LED 4x180 TYPE BC+A



PROJECTOR SUPPORT

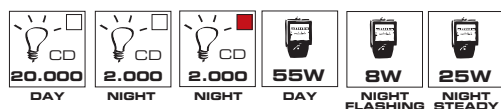

NIGHT/DAY - POWER CABINET - ICAO

APPLICAZIONI PRINCIPALI / TYPICAL APPLICATIONS APPLICATIONS PRINCIPALES

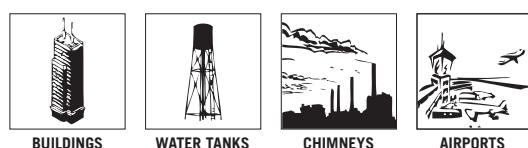

ACCESSORI / ACCESSORIES / ACCESSOIRES



Segnalatore Ostacolo Volo a Media Intensità progettato secondo la normativa ICAO Media Intensità Tipo A, B, C, B+A, C+A, BC+A.

OBSTAFLASH LED 180° è composto da 3 proiettori a LED indipendenti, alimentati a 48V DC e pilotati da un **POWER CABINET** in acciaio inox. In dotazione connettore dedicato per cablaggio sul segnalatore.

OBSTAFLASH LED 180°, disponibile nelle versioni con luce rossa lampeggiante (50528), rossa fissa (50529), con luce bianca lampeggiante (50530), rossa e bianca lampeggiante (50531), rossa fissa e bianca lampeggiante (50532), è la soluzione ideale per la segnalazione diurno e/o notturna di qualsiasi ostacolo volo in particolare di immobili con altezza elevata superiore ai 45m. Per gli ostacoli di altezza inferiore ai 150 metri l'uso di luce dual color o bianca durante il giorno non rende necessario dipingere l'ostacolo con strisce bianche e rosse.

Il segnalatore deve essere utilizzato con fotocellula esterna (vedi pagina accessori), collegata al **POWER CABINET** e orientata verso il Nord (nell'emisfero Nord).

Disponibile versione **KIT OBSTAFLASH LED 4x180° TYPE BC+A** composto da 4 segnalatori comprensivi di cablaggio (lunghezza da concordare in fase d'ordine), alimentati a 48V DC o 230V AC, pilotati da **POWER CABINET** in acciaio inox. Ideale per la segnalazione di edifici.

Tensione operativa

48V DC, 230V AC (50/60Hz) +/-10% tramite **POWER CABINET**

Per versioni 48V DC, alimentazione opzionale tramite **BATTERY CABINET** disponibile a richiesta.

Caratteristiche meccaniche

Corpo proiettore in alluminio e vetro

Supporto verticale in acciaio inox

Caratteristiche luminose

Larghezza del fascio orizzontale 360° (con almeno due segnalatori visibili da ogni lato dell'ostacolo)

Larghezza del fascio verticale >3°

Fissaggio

Tramite supporto verticale in acciaio inox con 4 punti di fissaggio

Caratteristiche Tecniche

POWER CABINET

- Sicurezza: interruzione automatica della tensione all'apertura del box di alimentazione
- Protezione sovratensione inclusa
- Segnalazione di allarme tramite contatto pulito NC (chiuso) o NO (aperto) in caso di malfunzionamento dei segnalatori o mancanza di alimentazione
- Commutatore di test con modalità remoto (fotocellula) / giorno / notte
- Sincronizzazione master/slave di più **POWER CABINET** tramite cavo blindato 3G1,5
- 8 Indicatori a led per una facile diagnostica
- Contatto per integrazione crepuscolare
- Possibilità di collegare luci intermedie a Bassa Intensità Tipo B (**NAVILITE** 48V DC) per il funzionamento notturno

POWER CABINET disponibile per 2, 3 o 4 segnalatori dual color o per 2 fino a 12 segnalatori di colore rosso

Accessori

Fotocellula crepuscolo/notte in conformità ICAO e FAA (maggiori info alla pagina accessori)

Modulo **GPS SYNCHRO** per la sincronizzazione di impianti separati secondo norma ICAO e FAA (maggiori info alla pagina accessori)

KIT DIAGNOSTIC GPRS per il monitoraggio a distanza dello stato dei segnalatori, delle batterie e della presenza rete (maggiori info alla pagina accessori)

Certificazioni / Certifications



ICAO International Standards and Recommended Practices:
 Aerodromes - Annex 14 Volume 1, 4th Edition,
 November 2004 Chapter 6

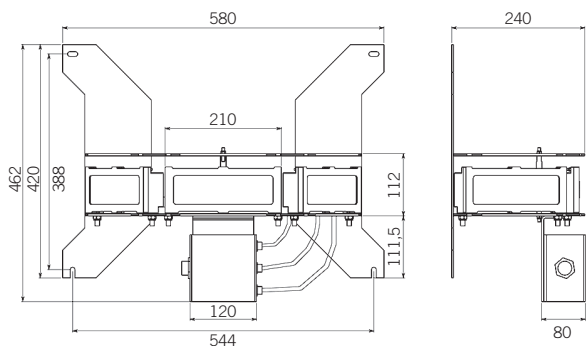

OBSTAFLASH LED 180°

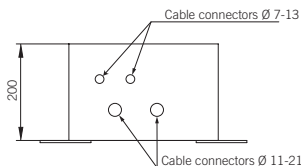
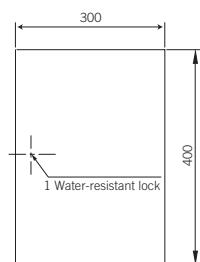

POWER CABINET



Codici / Codes

- OBSTAFLASH LED 180 TYPE B 48V DC R 50528
- OBSTAFLASH LED 180 TYPE C 48V DC R 50529
- OBSTAFLASH LED 180 TYPE A 48V DC W 50530
- OBSTAFLASH LED 180 TYPE B+A 48V DC RW 50531
- OBSTAFLASH LED 180 TYPE C+A 48V DC RW 50532

Per versioni 230V AC POWER CABINET addizionale (50533)
 For 230V AC versions additional POWER CABINET (50533)
 Pour versions 230V AC POWER CABINET additionnel (50533)

- KIT OBSTAFL. LED 4x180 TYPE BC+A 48V DC RW 50534
- KIT OBSTAFL. LED 4x180 TYPE BC+A 230V AC RW 50535

ACCESSORI E RICAMBI / ACCESSORIES AND SPARE PARTS
 ACCESSOIRES ET RECHANGES

- POWER CABINET 4x180 230V AC 50533
- POWER CARD 50536
- PHOTOCELL
- In base alla tensione di alimentazione
 According to voltage / Selon la tension d'alimentation
- SYNCHRO GPS 24-48V DC 50538
- DIAGNOSTIC 3G/GPRS 50539



Medium Intensity Aircraft Warning Light engineered according to ICAO Medium Intensity Type A, B, C, B+A, C+A regulation.

OBSTAFLASH LED 180° is provided with 3 independent LED projectors 48V DC, powered by a stainless steel POWER CABINET. Wiring connector on the flash head included.

OBSTAFLASH LED 180° is available in the following LED versions: with red flashing light (50528), red steady light (50529), white flashing light (50530), dual color flashing light (50531), white flashing light and red steady (50532). OBSTAFLASH LED 180° is the ideal solution for day and/or night marking of all kind of obstacle higher than 45 meters. For obstacles below 150 meters the use of white or dual color during daytime obviates the need to paint the obstacle with red and white stripes.

The product shall be used with an external photocell (see accessories section), connected to the POWER CABINET and oriented to the North (in the North Hemisphere).

KIT OBSTAFLASH LED 4x180° TYPE BC+A including 4 warning lights supplied with wiring cables (length to be agreed when ordering), 48V DC or 230V AC, powered by a stainless steel POWER CABINET.

OBSTAFLASH LED 180° is the ideal solution for buildings.

Voltages

48V DC, 230V AC (50/60Hz) +/-10% (through POWER CABINET)

For 48V DC versions, optional power supply through BATTERY CABINET (available on request)

Mechanical features

Aluminum and glass projector body
 Stainless steel vertical support

Optical features

Horizontal beam spread 360° (at least 2 warning lights visible from each side of the obstacle)
 Vertical beam spread >3°

Fixing

Through stainless steel vertical support with 4 fixing points

Technical features

- POWER CABINET
- Safety alarm closing contact
- Surge protection
- NC and NO alarm dry contact in case of failure of the light or of the power supply
- Test button with three positions: remote (photocell) / day / night
- Master/slave configuration in case of use of more POWER CABINET through shielded cable 3G1,5
- 8 luminous LED indicators for an easy diagnostic
- Integrated photocell switch
- Possibility to connect intermediate Low Intensity Type B (NAVILITE 48V DC) lights for night operation only
- POWER CABINET available for 2,3 or 4 dual color warning lights or for 2 up to 12 red warning lights

Accessories

Twilight/night photocell according to ICAO and FAA norms (see accessories section)

GPS SYNCHRO interface for synchronisation of separate installations according to ICAO and FAA norms (see accessories section)

KIT DIAGNOSTIC GPRS allows remote diagnostic of lights and their power supply or of the batteries (see accessories section)



Feu de Balisage Aérien Moyenne Intensité conforme aux normes OACI Moyenne Intensité Type A, B, C, B+A, C+A, BC+A.

OBSTAFLASH LED 180° est composé de 3 projecteurs à LED indépendants, alimentés en 48V CC et pilotés depuis un POWER CABINET en acier inoxydable. Fourni avec les connecteurs pour le câblage des feux.

OBSTAFLASH LED 180°, versions disponibles : lumière rouge clignotante (50528) ; rouge fixe (50529) ; blanche clignotante (50530) ; rouge et blanche clignotante (50531) ; rouge fixe/blanche clignotante (50532), c'est la solution idéale pour une signalisation diurne et/ou nocturne de tout type d'obstacle et particulièrement ceux d'une hauteur supérieure à 45 mètres. Pour les obstacles d'une hauteur inférieure à 145 mètres, l'utilisation de feux bicolores ou blancs durant le jour rend facultative la peinture en rouge et blanc de l'obstacle.

Le feu doit être utilisé avec une photocellule externe (voir page accessoires), connectée à l'armoire d'alimentation et orientée vers le Nord (dans l'hémisphère Nord).

Disponible version KIT OBSTAFLASH LED 4x180° TYPE BC+A composé de 4 feux fournis avec fils de câblage (longueur à convenir lors de la commande), alimentation 48V CC ou 230V CA, pilotés depuis un POWER CABINET en acier inoxydable. Idéal pour le balisage de bâtiments.

Tension d'alimentation

48V CC, 230V CA (50/60Hz) +/-10% par le POWER CABINET

Disponible sur demande pour la version 48V CC : alimentation par BATTERY CABINET

Caractéristiques mécaniques

Corps des projecteurs en aluminium et verre
 Support vertical en acier inoxydable

Caractéristiques lumineuses

Largeur du faisceau horizontal 360° (avec au moins 2 feux visibles de chaque côté de l'obstacle)
 Largeur du faisceau vertical <3°

Système de fixation

Support vertical en acier inoxydable, 4 points de fixation

Caractéristiques techniques

- POWER CABINET
- Sécurité : interruption automatique de l'alimentation à l'ouverture de l'armoire d'alimentation
- Protection contre les surtensions
- Renvoi d'alarme par contact sec, NC (fermé) ou NO (ouvert) en cas de dysfonctionnement des feux ou d'un manque d'alimentation
- Bouton de test jour/nuit
- Synchronisation maître/esclave des armoires à travers un câble 3G1,5
- 8 indicateurs LED pour un diagnostic simple de l'état du système
- Possibilité de connecter des feux Basse Intensité Type B (NAVILITE 48V CC) intermédiaires pour application nocturne
- Contact pour interrupteur crépusculaire
- POWER CABINET disponible pour 2, 3 ou 4 feux bicolores ; ou pour 2 à 12 feux rouges

Accessoires

Photocellule crépuscule/nuit conforme aux normes OACI et FAA (informations complémentaires page accessoires)

Module GPS SYNCHRO pour synchronisation des installations distantes selon les normes OACI et FAA (informations complémentaires page accessoires)

KIT DIAGNOSTIC GPRS pour contrôle à distance de l'état des feux, des batteries et de la présence de réseau (informations complémentaires page accessoires)

OBSTAFLASH LED HI 110/240V AC



OBSTAFLASH LED HI TYPE A

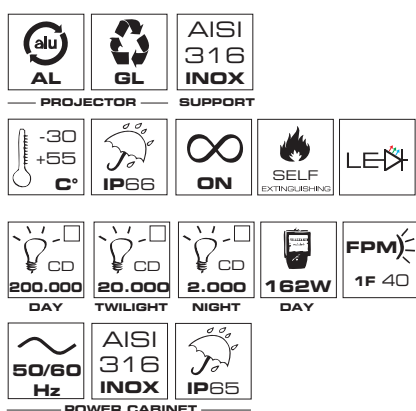

APPLICAZIONI PRINCIPALI / TYPICAL APPLICATIONS APPLICATIONS PRINCIPALES

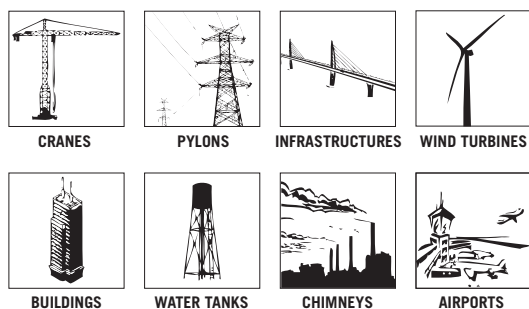

ACCESSORI / ACCESSORIES / ACCESSOIRES



Segnalatore Ostacolo Volo ad Alta Intensità progettato secondo la normativa ICAO Alta Intensità Tipo A (bianco).

OBSTAFLASH LED HI è un segnalatore ad Alta Intensità dedicato alla segnalazione diurna e notturna di ostacoli volo la cui altezza è superiore ai 150m. Il segnalatore è composto da 8 proiettori a LED a luce bianca lampeggiante alimentati singolarmente e separatamente tramite POWER CABINET.

Il segnalatore deve essere utilizzato con fotocellula esterna (vedi pagina accessori), collegata al POWER CABINET e orientata verso il Nord (nell'emisfero Nord).

Tensione operativa

110/240V AC (50/60Hz) +/-10% tramite POWER CABINET in acciaio inox IP65 con ingresso cavi dal basso

Caratteristiche meccaniche

Corpo segnalatore in alluminio e vetro
Supporto verticale in acciaio inox

Caratteristiche luminose

Larghezza del fascio orizzontale 120° (singolo segnalatore) - 360° con 3 segnalatori fissati a 120° intorno all'ostacolo
Larghezza del fascio verticale >3°

Fissaggio

Tramite supporto verticale in acciaio inox con 4 punti di fissaggio

Caratteristiche Tecniche

POWER CABINET

- Sicurezza: interruzione automatica della tensione all'apertura del box di alimentazione
- Protezione sovratensione inclusa
- Segnalazione di allarme tramite contatto pulito NC (chiuso) o NO (aperto) in caso di malfunzionamento di uno o più proiettori o mancanza di alimentazione
- Commutatore di test con modalità giorno / crepuscolo / notte
- 8 Indicatori a led per una facile diagnostica
- Contatto per integrazione crepuscolare
- Sincronizzazione di più segnalatori con configurazione master/slave (1 segnalatore master e l'altro slave) tramite cavo in rame o in fibra ottica

Accessori

HIGH INTENSITY PHOTOCELL 50/500LUX 48V DC: fotocellula doppia soglia per il cambio di intensità dei segnalatori Alta Intensità Tipo A (maggiori info alla pagina accessori)

Modulo **GPS SYNCHRO** per la sincronizzazione di impianti separati secondo norma ICAO e FAA (maggiori info alla pagina accessori)

KIT DIAGNOSTIC GPRS per il monitoraggio a distanza dello stato dei segnalatori, delle batterie e della presenza rete (maggiori info alla pagina accessori)

Certificazioni / Certifications



ICAO International Standards and Recommended Practices:
Aerodromes - Annex 14 Volume 1, 4th Edition, November 2004
Chapter 6



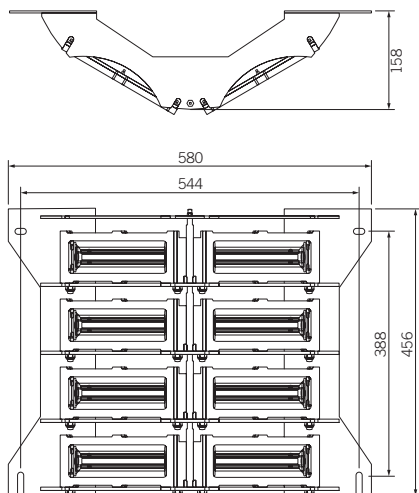

**OBSTAFASH LED HI
110/240V AC**

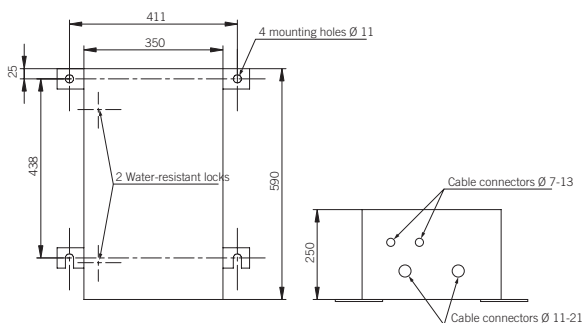

POWER CABINET



High Intensity Aircraft Warning Light engineered according to ICAO High Intensity Type A (white) regulation.

OBSTAFASH LED HI is a High Intensity white flashing light designed for day and night marking of obstacles higher than 150m. The product is provided with 8 white flashing light LED projectors, separately and individually powered by a stainless steel **POWER CABINET**.

The product shall be used with an external photocell (see accessories section), connected to the **POWER CABINET** and oriented to the North (in the North Hemisphere).

Voltages

110/240V AC (50/60Hz) +/-10% (through stainless steel IP65 **POWER CABINET** at the bottom of the obstacle, cable entry from the bottom).

Mechanical features

Aluminum and glass projector body
Stainless steel vertical support

Optical features

Horizontal beam spread 120° (single light) - 360° with 3 warning lights distributed at 120° around the obstacle
Vertical beam spread >3°

Fixing

Through stainless steel vertical support with 4 fixing points

Technical features

POWER CABINET

- Safety alarm closing contact
- Surge protection
- NC and NO alarm dry contact in case of failure of the light or of the power supply
- Test button with three positions: remote (photocell) / day / night
- 8 luminous LED indicators for an easy diagnostic
- Integrated photocell switch
- Master/slave configuration for multiple lights synchronisation through copper cable or external controller with optical cable

Accessories

HIGH INTENSITY PHOTOCCELL 50/500LUX 48V DC: Photocell for day/twilight and twilight/night light output change, to be used with the High Intensity Aircraft Warning Lights Type A (see accessories section)

GPS SYNCHRO interface for synchronisation of separate installations according to ICAO and FAA norms (see accessories section)

KIT DIAGNOSTIC GPRS allows remote diagnostic of lights and their power supply or of the batteries (see accessories section)



Feu de Balisage Aérien à Haute Intensité conforme aux normes OACI Haute Intensité Type A (blanc).

OBSTAFASH LED HI est un feu à Haute Intensité dédié à la signalisation diurne et/ou nocturne d'obstacles verticaux d'une hauteur supérieure à 150m.

Le feu est composé de 8 projecteurs à LED blanches clignotantes, alimentés individuellement et séparément par le **POWER CABINET**.

Le feu doit être utilisé avec une photocellule externe (voir page accessoires), connectée à l'armoire d'alimentation et orientée vers le Nord (dans l'hémisphère Nord).

Tension d'alimentation

110/240V CA (50/60Hz) +/-10% par le **POWER CABINET** en acier inoxydable IP65 avec entrée de câbles pas le dessous

Caractéristiques mécaniques

Corps du feu en aluminium et verre
Support vertical en acier inoxydable

Caractéristiques lumineuses

Largeur du faisceau horizontal 120° (feu individuel) - 360° avec 3 feux disposés à 120° autour de l'obstacle.
Largeur du faisceau <3°

Système de fixation

Support vertical en acier inoxydable avec 4 points de fixation

Caractéristiques techniques

POWER CABINET

- Sécurité : interruption automatique de l'alimentation à l'ouverture de l'armoire d'alimentation
- Protection contre les surtensions
- Renvoi d'alarme par contact sec, NC (fermé) ou NO (ouvert) en cas de dysfonctionnement des feux ou d'un manque d'alimentation.
- Bouton de test jour/nuit/crépuscule
- Synchronisation maître/esclave des feux par un câble de cuivre ou fibre optique
- 8 indicateurs LED pour un diagnostic simple de l'état du système
- Contact pour interrupteur crépusculaire

Accessoires

HIGH INTENSITY PHOTOCCELL 50/500LUX 48V DC : photocellule double seuil pour le changement d'intensité Type A (informations supplémentaires à la page accessoire).

Module **GPS SYNCHRO** pour synchronisation des installations distantes selon les normes OACI et FAA (informations complémentaires page accessoires)

KIT DIAGNOSTIC GPRS pour le suivi à distance de l'état des feux, des batteries et de la présence de réseau (informations supplémentaires à la page accessoire)

Codici / Codes

○ OBSTAFASH LED HI TYPE A 110/240V AC W 50540

**ACCESSORI E RICAMBI / ACCESSORIES AND SPARE PARTS
ACCESSOIRES ET RECHANGES**

POWER CARD	50536
HIGH INTENSITY PHOTOCCELL 48V DC	50541
SYNCHRO GPS 24-48V DC	50538
DIAGNOSTIC 3G/GPRS	50539

ACCESSORI E RICAMBI

ACCESSORIES AND SPARE PARTS



ACCESSOIRES ET PIECES DE RECHANGE



NAVILITE
FIXING
BRACKET

NAVILITE FIXING BRACKET

Staffa di fissaggio per un NAVILITE e COMMAND BOX

-  Stainless steel support for one NAVILITE and COMMAND BOX
-  Équerre de fixation inox pour une balise NAVILITE et un COMMAND BOX



Codici / Codes

NAVILITE FIXING BRACKET

50505



NAVILITE D/N
COMMAND BOX

NAVILITE D/N COMMAND BOX

BOX di comando che consente il controllo e il cablaggio di 1 o 2 NAVILITE 48V DC, che operano solo di notte o in modo continuo, collegati per funzionare simultaneamente o in ridondanza (una luce principale e una luce secondaria che si attiva solo in caso di guasto della luce principale). Segnalazione remota in caso di guasto della luce o dell'alimentazione.

-  Monitoring box allowing the control and the wiring of 1 or 2 NAVILITE 48V DC beacon, working at night only or continuously, plugged to work simultaneously or in redundancy (a main light and a backup light operating only in case the main light is not working) with remote signalization in case of failure of the light or failure of the supply.

-  Boîtier de commande permettant le contrôle et le raccordement de 1 ou 2 feux NAVILITE 48V CC fonctionnant de nuit ou bien en permanence, en fonctionnement simultané ou bien en redondance (1 lampe principale et une lampe de secours qui ne fonctionne qu'en cas de panne de la lampe principale) avec renvoi d'alarme en cas de défaut lampe ou défaut alimentation.



Codici / Codes

NAVILITE D/N COMMAND BOX



48V DC	50506
230V AC	50507



OBSTAFLASH
POWER CARD

OBSTAFLASH POWER CARD

OBSTAFLASH POWER CARD regola la corrente dei circuiti a LED all'interno dei proiettori.

-  OBSTAFLASH POWER CARD regulate the current in the LED circuits inside the projectors.
-  OBSTAFLASH POWER CARD régule le courant dans les circuits LED à l'intérieur des projecteurs.

Codici / Codes

OBSTAFLASH POWER CARD

50536



**BATTERY CABINET
48V DC**

Gli ostacoli richiedono una segnalazione permanente, occorre per tanto alimentare i segnalatori tramite un armadio batterie.

The obstacles which require permanent back-up must be fed by a battery cabinet.

Les obstacles nécessitent un balisage permanent pour lequel il faut assurer une continuité de l'alimentation électrique.

BATTERY CABINET

L'armadio a batterie è alimentato tramite AC e fornisce 48V DC con 12 ore di autonomia in caso di guasto elettrico principale.

- Struttura in metallo
- Alimentato da 110V AC a 240V AC, uscita 48V DC
- Temperatura di funzionamento -20°C / + 45°C
- Protezione contro sovratensione in entrata AC e in uscita DC
- Protezione contro la scarica completa delle batterie

🇬🇧 The battery cabinet is powered through AC and provides a 48V DC with 12 hours of autonomy in case of main power failure.

- Metal enclosure
- 110V AC to 240V AC power supply, 48V DC output
- Operating temperature -20°C/+45°C
- Protection against transient overvoltage on AC and DC side
- Protection against deep discharge batteries

🇫🇷 Ces armoires sont utilisées pour assurer une autonomie de 12 heures de fonctionnement de nos feux fonctionnant en tension continue 48V.

- Enceinte métallique
- Tension d'alimentation de 110V CA à 240V CA en entrée
- Température de fonctionnement -20°C/+45°C
- Protection contre les surtensions en entrée (AC) et en sortie (DC)
- Protection contre la décharge complète des batteries

Codici / Codes

BATTERY CABINET per / for / pour:

- 1 NAVILITE 48V 2,1Ah	50546
- 2 / 3 NAVILITE 48V 4,5Ah	50547
- 4 NAVILITE 48V 7Ah	50548
- 8 NAVILITE 48V 12Ah or 1 OBSTAFLASH LED	50549
- 16 NAVILITE 48V 24Ah or 1 OBSTAFLASH LED	50550



Il peso dipende dalla versione
Weight depending on version
Poids selon la version



**BATTERY CABINET
7Ah 1300W
IP65**

BATTERY CABINET IP65

Questi armadi sono utilizzati per assicurare un'autonomia di 12 ore di funzionamento delle luci a 48V DC. Devono essere dimensionati a seconda del numero e del tipo di luci.

- Struttura in metallo con rivestimento esterno in inox
- Tensione di alimentazione da 100V AC a 250V AC in entrata, 48V DC 1300W max in uscita
- Comparto batterie 7Ah integrato con possibilità di aggiungere batterie in un armadio esterno

🇬🇧 The battery cabinet is powered through AC and provides a 48V DC with 12 hours of autonomy in case of main power failure.

- Metal enclosure with external stainless envelope
- 100V AC to 250V AC power supply, 48V DC 1300W max output
- 7Ah integrated battery compartment, possibility to add batteries in external cabinet

🇫🇷 Ces armoires sont utilisées pour assurer une autonomie de 12 heures de fonctionnement de nos feux fonctionnant en tension continue 48V. Leur taille dépend du nombre et du type de lampes.

- Enceinte métallique avec capot en inox
- Tension d'alimentation de 100V CA à 250V CA en entrée, 48V DC 1300W max en sortie
- Compartiment batterie 7Ah intégré avec possibilité d'ajouter des batteries dans une armoire extérieure



Codici / Codes

BATTERY CABINET IP65

50551



PHOTOCELL

PHOTOCELL

Fotocellula giorno/notte in conformità ICAO e FAA che permette il funzionamento notturno delle luci notturne o il cambio del colore e dell'intensità luminosa giorno/notte delle luci OBSTAFASH LED.

- Fissaggio plug-in
- Timer per prevenire il funzionamento inopportuno della fotocellula (es. fulmini)

Photo cell for day/night intensity change in accordance with ICAO and FAA for all night signaling devices or for the change of color and light-intensity of the OBSTAFASH LED.

- Plug-in modular construction with plated contact surfaces
- Timer to prevent the functioning of the cell at inopportune times (lightning)

Cellule photoélectrique jour/nuit en conformité avec l'OACI et le FAA permettant le fonctionnement de nuit uniquement des feux nocturnes ou bien le changement de couleur et d'intensité lumineuse jour/nuit des feux diurnes et nocturnes de tous les feux OBSTAFASH LED.

- Embrochable sur socle
- Temporisation permettant d'éviter le fonctionnement de la cellule sur des éclats intempestifs (éclairs par exemple)

Codici / Codes

PHOTOCELL



24V DC	50545
48V DC	50544
120V AC	50543
230V AC	50542



**HIGH INTENSITY
PHOTOCELL**
48V DC 50/500 Lux

HIGH INTENSITY PHOTOCELL

Fotocellula doppia soglia (giorno/crepuscolo e crepuscolo/notte) 48V DC per il cambio di intensità dei segnalatori Alta Intensità Tipo A conforme alla norma ICAO.

- 2 fotocellule plug-in fissate su di un box di giunzione consentono la commutazione automatica dei segnalatori Alta Intensità in funzione della luminosità ambientale giorno/crepuscolo (soglia calibrata su 500 Lux) e crepuscolo/notte (soglia calibrata su 50 Lux)
- Timer per prevenire il funzionamento inopportuno della fotocellula (es. fulmini)

48V DC Photocell for day/twilight and twilight/night change of light output in accordance with ICAO to be used with High Intensity Aircraft Warning Lights Type A.

- 2 plug-in photocell fixed on a junction box allowing automatic control of the obstruction lights according to ambient light day/twilight (setting 500 Lux) and night/twilight (setting 50 Lux)
- timer to prevent the functioning of the cell at inopportune times (lightning)

Cellule photoélectrique à 2 seuils jour/crépuscule et crépuscule/nuit en conformité avec l'OACI pour le changement d'intensité des feux Haute Intensité Type A.

- 2 cellules embrochables sur socle fixées sur un boîtier de raccordement permettant la commande automatique du balisage Haute Intensité en fonction de la luminosité ambiante jour/crépuscule (seuil calibré à 500 Lux) et crépuscule/nuit (seuil calibré à 50 Lux)
- temporisation permettant d'éviter le fonctionnement de la cellule sur des éclats intempestifs (éclairs par exemple)



Codici / Codes

HIGH INTENSITY PHOTOCELL

48V DC	50541
--------	-------

SYNCHRO GPS

L'unità di controllo GPS è un modulo con 2 uscite, una per la sincronizzazione del lampeggio e l'altra opzionale per il cambio della luminosità e del colore giorno/notte.

Nel caso in cui 2 o più luci lampeggianti siano installate sullo stesso ostacolo, le normative ICAO e FAA richiedono che le luci siano sincronizzate.

Se non è possibile collegare tra loro i segnalatori lampeggianti tramite un cavo, il modulo GPS permette di sincronizzare il lampeggio di un gruppo di segnalatori senza l'utilizzo di cavi.

- Tensione di alimentazione: 24V-48V DC +/-15%
- Attacco DIN
- Dip-switch per la selezione della frequenza di lampeggio (20 o 40 flash al minuto)
- Sincronizzazione dei lampeggi utilizzando un orologio GPS esterno e indipendente (primo secondo di ogni minuto)
- È inoltre possibile la sincronizzazione della commutazione giorno/notte senza l'utilizzo di una fotocellula
- Due indicatori luminosi: verde per la commutazione giorno/notte, rosso per la sincronizzazione dei lampeggi



SYNCHRO GPS 24-48V DC

🇬🇧 The GPS control unit is a DIN rail module with 2 outputs, one for flash synchronisation and one optional for day/night change of light output and color.

In case 2 or more flashing lights are installed on the same obstacle, ICAO and FAA request that the lights should be synchronized.

In case it is not possible to install a wire between the flashing lights, the GPS allows synchronizing a group of flashing lights without the need of installing a cable between them.

- Voltage: 24V-48V DC +/-15%
- DIN rail mounting
- Dip-switch to select the frequency of flashes (20 or 40 flashes per minute)
- It allows the synchronization on an external and independent timing (first second of each minutes of GPS mode)
- Simultaneous day/night mode switching without using the photocell
- 2 luminous indicators: green for day/night switch, red indicator for flash synchronization

🇫🇷 Le module GPS permet la fixation sur rail DIN avec deux sorties, une pour la synchronisation des éclats et l'autre optionnelle pour le changement d'intensité ou de couleur jour/nuit.

Si deux feux à éclats ou plus sont installés sur le même obstacle, l'OACI et la FAA exigent que les éclats et le changement d'intensité ou de couleur soient synchronisés. Dans le cas où il n'est pas possible de relier les feux entre eux par un câble, le module GPS permet de synchroniser sans fil plusieurs feux à éclats sans aucun lien filaire entre eux.

- Tension d'utilisation: 24V-48V DC +/-15%
- Fixation sur rail DIN
- Micro-interrupteur pour cadencement des éclairs (20 ou 40 éclairs par minute)
- Synchronisation des éclats sur la première seconde de chaque minute de l'horloge GPS
- Egalement possible, la synchronisation de la commutation jour/nuit à la place de la cellule photoélectrique
- 2 indicateurs lumineux en façade : vert pour le mode jour/nuit, rouge pour la synchronisation des éclats

Codici / Codes

SYNCHRO GPS

50538



DIAGNOSTIC 3G/GPRS

Il kit DIAGNOSTIC GPRS permette il monitoraggio a distanza dello stato dei segnalatori OBSTAFASH, delle batterie, della presenza rete e consente di ottimizzare la manutenzione ed intervenire velocemente in caso di malfunzionamento dei segnalatori.

Il kit comprende:

- un'interfaccia web dedicata
- un modem GPRS/3G con carta SIM tipo M2M (Machine to Machine) collegata a uno o due segnalatori a Media Intensità. Questo modem può anche essere collegato a più di due segnalatori tramite fibra ottica e interfacce ottiche addizionali installate su ogni segnalatore. Il kit consente di visualizzare lo stato delle luci ad intervalli stabiliti:
 - Stato delle luci e dell'alimentazione (stato proiettori, sincronismo, modalità giorno/notte, temperatura dell'alimentatore, configurazione segnalatori)
 - Curve telemetriche (tensione di ogni circuito a led, tensione alimentazione o delle batterie, temperatura)
 - Stato dei 3 contatti puliti provenienti dalle luci intermedie a Bassa Intensità o da altri dispositivi (protezione sovratensioni, carica batterie)
 - Allarme via mail



DIAGNOSTIC 3G/GPRS

🇬🇧 The DIAGNOSTIC GPRS kit allows a remote diagnostic of the OBSTAFASH in order to facilitate the curative and preventive maintenance of the projectors and the power supply.

This kit includes:

- a web interface
- a GPRS/3G modem installed with interface connected to one or two Medium Intensity Aircraft Warning Lights. The modem can also be connected to more than 2 lights through a dedicated optical network between the lights with additional optical interfaces. The kit allows recording the status of the lights at preset interval:
 - Status of the lights and their associated power supply (status of the projectors, of synchronisation, of the day/night mode, temperature inside the power supply, configuration of the flashheads)
 - Telemetric curves (voltage of each led circuits, of the power supply or batteries, temperature)
 - Status of 3 alarm contacts coming from intermediate Low Intensity lights or other devices (surge protection, charger, etc).
 - Alarm by email

🇫🇷 Le kit DIAGNOSTIC GPRS permet un diagnostic à distance des feux OBSTAFASH et de la tension des batteries. Cette interface permet d'optimiser les périodes de maintenance préventive des batteries et le suivi des balises.

Ce kit comprend :

- une interface web dédiée
- un modem GPRS/3G avec carte SIM raccordée à une ou deux balises Moyenne Intensité. Ce modem peut également être raccordé à plus de 2 balises via une fibre optique et des cartes optiques additionnelles installées dans chaque feu. Le kit permet la visualisation de l'état du feu à intervalles prédéfinies :
 - Etat des lampes et de la tension batterie (état de chaque projecteur, de la synchronisation état jour/nuit, température du coffret, configuration de l'alimentation)
 - Courbes télémétriques (tension de chaque circuits de leds, tension d'alimentation ou des batteries)
 - Etat de 3 contacts secs provenant des lampes Basse Intensité et du chargeur batterie
 - Système d'alerte par email

Codici / Codes

DIAGNOSTIC 3G/GPRS

50539



HELIX



HELIX

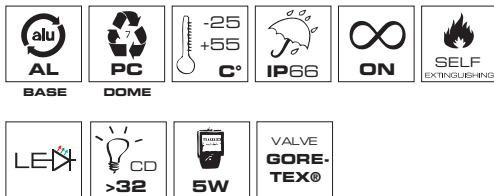
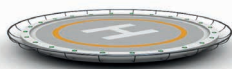

APPLICAZIONI PRINCIPALI / TYPICAL APPLICATIONS APPLICATIONS PRINCIPALES



HELIPADS

ACCESSORI / ACCESSORIES / ACCESSOIRES

PSU POWER
SUPPLY UNIT

SIDE BRACKET

Dispositivo a Bassa Intensità per la segnalazione perimetrale degli eliporti.

Con una base a peso ridotto progettata per la dispersione del calore, questo dispositivo è la soluzione ideale per un Segnalatore Perimetrale Eliporto efficiente e di lunga durata. **HELIX** è dotato di luce verde fissa e di 2 fonti luminose: orizzontale e verticale.

La fonte orizzontale offre un fascio luminoso orizzontale omnidirezionale, con ampiezza verticale di +10°. La fonte verticale offre un fascio luminoso orizzontale omnidirezionale, con ampiezza verticale di 120°.

Il circuito LED garantisce inoltre la lunga vita del prodotto (oltre 10 anni) ed il basso consumo del dispositivo (1/10 rispetto alle versioni tradizionali ad incandescenza).

Tensione operativa

12/30V DC +/-10%

110/240V AC (50/60Hz) tramite alimentatore **PSU** (51011)

Caratteristiche meccaniche

Corpo segnalatore in alluminio

Cupola in policarbonato

Caratteristiche luminose / Optical features / Caractéristiques lumineuses

CAMPO DI IRRADIAZIONE

IRRADIATION BEAM

CHAMPS D'IRRADIATION

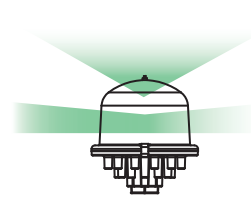

VISTA LATERALE - IRRADIAZIONE VERTICALE

SIDE VIEW - VERTICAL IRRADIATION

VUE LATÉRALE - IRRADIATION VERTICALE

FRONTE ORIZZONTALE = 10° - FRONTE VERTICALE = 120°

HORIZONTAL LIGHT = 10° - VERTICAL LIGHT = 120°

SOURCE HORIZONTAL = 10° - SOURCE VERTICALE = 120°



VISTA DALL'ALTO - IRRADIAZIONE ORIZZONTALE

TOP VIEW - HORIZONTAL IRRADIATION

VUE DE HAUT - IRRADIATION HORIZONTALE

FRONTE ORIZZONTALE = 360° - FRONTE VERTICALE = 360°

HORIZONTAL LIGHT = 360° - VERTICAL LIGHT = 360°

SOURCE HORIZONTAL = 360° - SOURCE VERTICALE = 360°

Fissaggio

Su palo | Diretto tramite 3/4" NPT-F

Accessori

PSU Alimentatore 110/240V AC per dispositivi **HELIX** (utilizzare un alimentatore per ogni dispositivo **HELIX**)

SIDE BRACKET Staffa laterale in acciaio inox, consente l'installazione su pareti, pali e strutture laterali (51013)

Certificazioni / Certifications



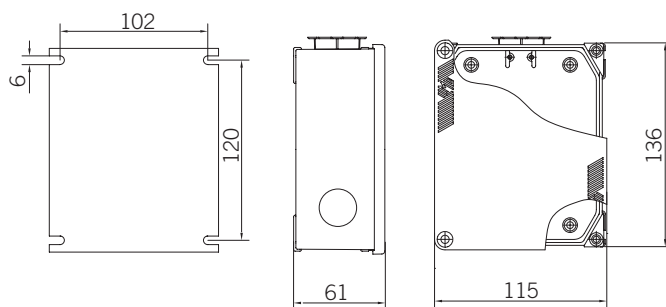
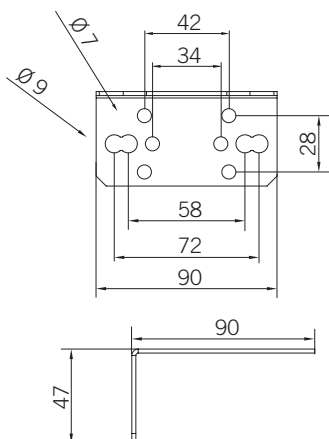
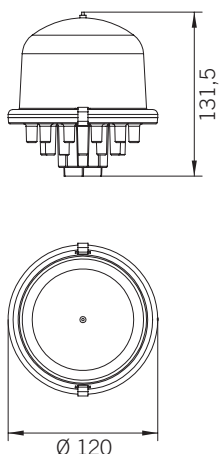

HELIX



SIDE BRACKET



PSU



Low Intensity heliport perimeter light.

With a lightweight heat sink base, this device is the ideal solution for an efficient and long lasting quality perimeter beacon.

HELIX is provided with a green steady light, this device has 2 light sources: horizontal and vertical. The horizontal light is equipped with an optical reflector that guarantees a 360° horizontal beam radiation and a vertical beam of +10°. The vertical light has a horizontal beam radiation of 360° and a vertical beam of 120°.

The LED circuit guarantees a long product life estimated in over 10 years, as well as low consumption (1/10 when compared to incandescent bulbs).

Voltages

12/30V DC +/-10%
110/240V AC (50/60Hz) through power supply unit PSU (51011)

Mechanical features

Aluminum body
Polycarbonate dome

Fixing

Pole mounting | Direct (3/4" NPT-F)

Accessories

PSU Power supply unit 110/240V AC (one for each HELIX light).

SIDE BRACKET Stainless steel side mounter, allows lateral mounting to walls, side poles or side structures (51013).



Dispositif de signalisation Basse Intensité prévu pour la délimitation de périmètre d'héliport

Développé avec un dissipateur thermique léger, ce dispositif est la solution idéale pour une signalisation efficace et durable du périmètre d'un héliport.

HELIX diffuse une lumière verte fixe avec 2 sources lumineuses : horizontale et verticale. La source horizontale diffuse un faisceau lumineux horizontal omnidirectionnel d'une amplitude verticale de +10°. La source verticale diffuse un faisceau lumineux horizontal et omnidirectionnel d'une amplitude verticale de 120°.

Le circuit LED garantit une longue durée de vie au dispositif (environ 10 ans) et une basse consommation (10 fois inférieure par rapport aux versions traditionnelles à ampoule à incandescence).

Tension d'alimentation

12/30V CC +/-10%
110/240V CA (50/60Hz) alimenté par le PSU (51011)

Système de fixation

Sur hampe : directement par 3/4" NPT-F

Caractéristiques mécaniques

Corps de la balise en aluminium
Dôme en polycarbonate

Accessoires

Alimentateur PSU 110/240V CA (un alimentateur par dispositif).

SIDE BRACKET Support de fixation latéral en acier inoxydable (51013).

Codici / Codes

● HELIX 12/30V DC 51012

**ACCESSORI E RICAMBI / ACCESSORIES AND SPARE PARTS
ACCESSOIRES ET RECHANGES**

PSU 110/240V AC 51011
SIDE BRACKET 51013

AWL 810/C



AWL 810/C

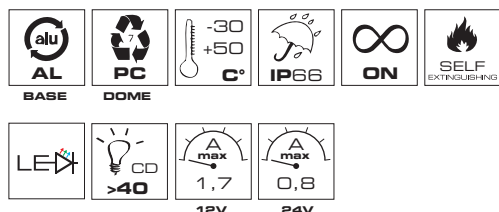

APPLICAZIONI PRINCIPALI / TYPICAL APPLICATIONS APPLICATIONS PRINCIPALES



Codici / Codes

ISO B1 BASE (FLAT)
ISO A BASE (PLUG)
MAGNETIC BASE

●	●
51038	51041
51039	51042
51040	51043

Luce di segnalazione a Bassa Intensità per veicoli aeroportuali progettata secondo la normativa ICAO Bassa Intensità Tipo C.

Con una base ad alta dispersione di calore, **AWL 810/C** è la soluzione ideale per una luce efficiente e di lunga durata.

Dotata di luce a effetto flash, la lente ottica garantisce un fascio luminoso orizzontale omnidirezionale, con ampiezza verticale tra +0° e +12°.

Il circuito LED garantisce inoltre la lunga vita del prodotto (oltre 10 anni) ed il basso consumo del dispositivo (1/10 rispetto alle versioni tradizionali con lampada a incandescenza). Disponibile in colore ambra per i veicoli terrestri aeroportuali e in blu per utilizzo su veicoli prioritari aeroportuali.

Tensione operativa

12/24V DC +/-10%

Caratteristiche tecniche

Tecnologia LED | Basso consumo | Fascio luminoso stabilizzato

Fissaggio

Superficiale | Su superfici piane (secondo standard ISO B1, 3 fori ad intervalli di 120°)

Su palo | Montaggio su spinotto ISO A

Base magnetica | Montaggio su superfici in acciaio. Alimentazione tramite cavo spiralato e spina accendisigari (in dotazione)

Certificazioni / Certifications



ICAO International Standards and Recommended Practices:
Aerodromes - Annex 14 Volume 1, 4th Edition, November 2004
Chapter 6

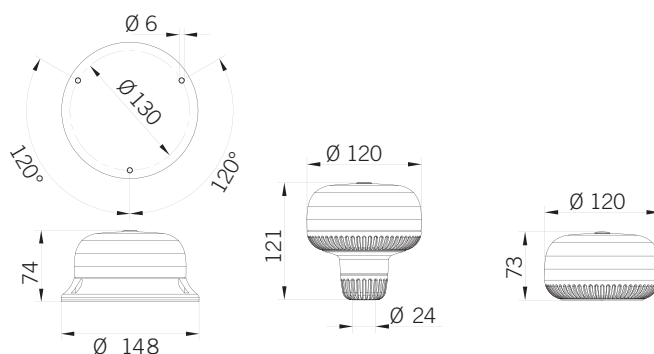

ISO B1



ISO A



MAGNETIC



Low Intensity airport vehicle Warning Light engineered according to ICAO Low Intensity Type C regulation.

With a lightweight heat sink base, **AWL 810/C** is the ideal solution for an efficient and long lasting quality warning beacon. Provided with a flashing light, its optical reflector guarantees a 360° horizontal beam radiation and a vertical beam between +0° and +12°.

The LED circuit guarantees a long product life estimated in over 10 years, as well as low consumption (1/10 when compared to incandescent bulbs). Available in amber for use with ground operation vehicles and in blue for use with airport priority vehicles.

Voltages

12/24V DC +/-10%

Technical features

LED technology
Low consumption
Stabilized light output

Fixing

Flat mounting | Mounting on flat surfaces (according to ISO B1 configuration, 3 holes at 120° intervals)

Plug mounting | Mounting to ISO A plug
Magnetic base | Mounting on metal surfaces.
Powering via helix cable and cigar plug (provided)



Feu de signalisation à Basse Intensité pour véhicules aéroportuaires conformes à norme OACI Basse Intensité Type C.

Avec une base à haute dissipation thermique, **AWL 810/C** est la solution idéale pour une signalisation efficace et durable.

Diffuse une lumière flash, la lentille optique garantit un faisceau lumineux horizontal omnidirectionnel d'une amplitude comprise entre +0° et +12°.

Le circuit LED garantit une longue durée de vie au dispositif (environ 10ans) et une basse consommation (10 fois inférieure aux versions traditionnelles avec ampoules à incandescence). Disponible en orange pour les véhicules de service au sol et en bleu pour les véhicules prioritaires.

Tension d'alimentation

12/24V CC +/-10%

Caractéristiques techniques

Tecnologia LED
Basse consommation
Faisceau lumineux stabilisé

Système de fixation

Surface plane : ISO B1, fixation 3 points 120° d'intervalle
Sur hampe : prise de connexion ISO A
Surface en acier : base magnétique. Alimentation par câble spiralé et prise allume-cigare (fourni)

FOLLOW-ME BAR



FOLLOW-ME BAR



CONTROL UNIT

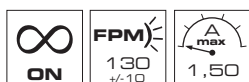

APPLICAZIONI PRINCIPALI / TYPICAL APPLICATIONS APPLICATIONS PRINCIPALES



GROUND OPERATION
VEHICLES

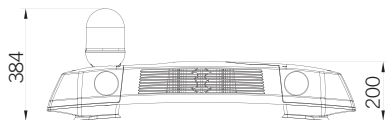
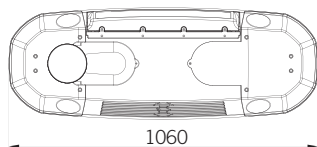

Codici / Codes

NWC B LD803.00 12V DC 67901
(versione standard / standard version / version standard)

NWC B LD903.00 12V DC 67888
(versione con faro brandeggiante
version with radio controlled motorized search beam
version avec phare de recherche radiocommandé)

Barra di segnalazione per veicoli aeroportuali.

FOLLOW-ME BAR è una barra multifunzionale con tecnologia a LED. Pannello luminoso a LED posteriore a messaggi variabili. 6 lingue selezionabili (max. 20 messaggi prememorizzati per ogni lingua - max. 10 messaggi personalizzabili - 10 caratteri).

FOLLOW-ME BAR può essere realizzata in diverse configurazioni atte a soddisfare le esigenze più svariate: con faro di ricerca radiocomandato, luci a LED di stationamento nel colore ambrato, fari alogeni H3.

Fornita con console di bordo dotata di pulsanti retroilluminati e display per la versione con pannello messaggi)

Tensione operativa

12V DC +/-10%

Caratteristiche luminose

LED: effetto FLASH

Intensità luminosa: secondo ECE R65

Caratteristiche meccaniche

Struttura e cupole in policarbonato



Faro di ricerca radiocomandato motorizzato

Luce di profondità o luce diffusa 55W - 120.000 Cd(p)
o 100W - 150.000 Cd(p)

Radio controlled motorized search beam

Depth or flood light 55W - 120.000 Cd(p)
or 100W - 150.000 Cd(p)

Phare de recherche radiocommandé et motorisé

Lumière de profondeur ou diffuse 55W - 120.000 Cd(p)
ou 100W - 150.000 Cd(p)



Luci di stationamento ambrato

Proiettori a LED frontali - laterali - posteriori

Amber parking lights

Frontal, side, rear LED spotlights

Feux de stationnement oranges

Projecteurs LED frontaux, latéraux et postérieurs



Luce fissa di profondità

Fari alogeni H3 55W (frontali - laterali - posteriori ambrato lampeggianti)

Steady depth light

H3 55W halogen spotlights (frontal - side - rear amber flashing)

Feux de profondeur fixes

Phares halogènes H3 55W (frontaux, latéraux, postérieurs, oranges clignotants)

Certificazioni / Certifications



Numeri di omologazione / Approval Numbers / Numéros d'homologation
ECE R65 TA1 E3 007128
EMC 2006/28/CE e24 031622



Airport Vehicle Warning light bar.

FOLLOW-ME BAR is a multifunctional light bar available with LED technology.

Permanent rear LED display (variable messages). 6 selectable languages (max. 20 pre-recorded messages for each language - max. 10 personalized messages - 10 characters).

FOLLOW-ME BAR offers different options suitable for all types of applications: radio controlled motorized search beam, amber LED parking lights, H3 halogen spotlights. Supplied with remote control console with backlit keys and display (version with message panel).

Voltagges

12V DC +/-10%

Mechanical features

Polycarbonate structure and domes

Optical features

LED flashing effect

Luminous Intensity according to ECE R65



Rampe de signalisation pour véhicules aéroportuaires.

FOLLOW-ME BAR est une rampe multifonction avec technologie LED.

Panneau lumineux à LED (messages variables). 6 langues sélectionnables (max. 20 messages préenregistrés pour chaque langue-max. 10 messages personnalisables - 10 caractères).

FOLLOW-ME BAR permet différentes configurations satisfaisant les exigences les plus variées : avec phare de recherche radiocommandé, feux de stationnement oranges à LED, phares halogènes H3. Fourni avec une console de bord, touches rétro-éclairées et écran pour la version avec panneau de messages.

Tension d'alimentation

12V CC +/-10%

Caractéristiques mécaniques

Corps et dômes en polycarbonate

Caractéristiques lumineuses

LED : effet flash

Intensité lumineuse selon norme ECE R65

CODICI / CODES

Code	Description	Section	Page	Code	Description	Section	Page
16663	LX4 071F SMD V24DC/AC 324	AUTOMAX	167	27481	CTL1200 X A AMB V12/24DAC GY	ELECTRA	40
16664	LX4 071F SMD V24DC/AC 423	AUTOMAX	167	27482	CTL1200 X A RED V12/24DAC GY	ELECTRA	40
21408	T4 LED GREEN V24DAC	FOUR	183	27483	CTL1200 X A GRE V12/24DAC GY	ELECTRA	40
21412	F4 LED AMBER V24DAC	FOUR	181	27484	CTL1200 X A YEL V12/24DAC GY	ELECTRA	40
21413	F4 LED RED V24DAC	FOUR	181	27492	CTL1200 X A BLU V240AC GY	ELECTRA	40
21414	F4 LED GREEN V24DAC	FOUR	181	27493	CTL1200 X A AMB V240AC GY	ELECTRA	40
21415	R4 LED RED V24DAC CHROME	FOUR	182	27494	CTL1200 X A RED V240AC GY	ELECTRA	40
21416	R4 LED AMBER V24DAC CHROME	FOUR	182	27495	CTL1200 X A GRE V240AC GY	ELECTRA	40
21417	R4 LED GREEN V24DAC CHROME	FOUR	182	27496	CTL1200 X A YEL V240AC GY	ELECTRA	40
21418	R4 LED RED V24DAC WHITE	FOUR	182	27566	CTL900 X A BLU V12/24DAC GY	ELECTRA	39
21419	R4 LED AMBER V24DAC WHITE	FOUR	182	27567	CTL900 X A AMB V12/24DAC GY	ELECTRA	39
21420	R4 LED GREEN V24DAC WHITE	FOUR	182	27568	CTL900 X A RED V12/24DAC GY	ELECTRA	39
22191	STR X 15J AMB S V12/24DC BK	ELECTRA	63	27569	CTL900 X A GRE V12/24DAC GY	ELECTRA	39
22192	STR X 15J RED S V12/24DC BK	ELECTRA	63	27570	CTL900 X A YEL V12/24DAC GY	ELECTRA	39
22195	STR X 15J CLR S V12/24DC BK	ELECTRA	63	27602	TWS HD SS ENCLOSURE (2)	AUTOMAX	157
22281	STR X 15J AMB P V12/24DC BK	ELECTRA	63	27603	TWS HD AL ENCLOSURE (2)	AUTOMAX	157
22282	STR X 15J RED P V12/24DC BK	ELECTRA	63	27606	TWS HD SS ENCLOSURE (4)	AUTOMAX	157
22285	STR X 15J CLR P V12/24DC BK	ELECTRA	63	27607	TWS HD AL ENCLOSURE (4)	AUTOMAX	157
26252	TYPE 200 LED AMB V24DAC GY	ELECTRA	60	27625	TWS SOUNDER PZ V12/48DAC BK	AUTOMAX	156
26253	TYPE 200 LED RED V24DAC GY	ELECTRA	60	27628	TWS SOUNDER PZ V110/240AC BK	AUTOMAX	156
26254	TYPE 200 LED GRE V24DAC GY	ELECTRA	60	27631	TWS STEADY BLU V12/240DAC BK	AUTOMAX	154
26255	TYPE 200 LED YEL V24DAC GY	ELECTRA	60	27632	TWS STEADY AMB V12/240DAC BK	AUTOMAX	154
26272	TYPE 200 LED AMB V110AC GY	ELECTRA	60	27633	TWS STEADY RED V12/240DAC BK	AUTOMAX	154
26273	TYPE 200 LED RED V110AC GY	ELECTRA	60	27634	TWS STEADY GRE V12/240DAC BK	AUTOMAX	154
26274	TYPE 200 LED GRE V110AC GY	ELECTRA	60	27635	TWS STEADY YEL V12/240DAC BK	AUTOMAX	154
26275	TYPE 200 LED YEL V110AC GY	ELECTRA	60	27636	TWS STEADY CLR V12/240DAC BK	AUTOMAX	154
26282	TYPE 200 LED AMB V240AC GY	ELECTRA	60	27641	TWS FLASH BLU V12/48DC BK	AUTOMAX	154
26283	TYPE 200 LED RED V240AC GY	ELECTRA	60	27642	TWS FLASH AMB V12/48DC BK	AUTOMAX	154
26284	TYPE 200 LED GRE V240AC GY	ELECTRA	60	27643	TWS FLASH RED V12/48DC BK	AUTOMAX	154
26285	TYPE 200 LED YEL V240AC GY	ELECTRA	60	27644	TWS FLASH GRE V12/48DC BK	AUTOMAX	154
26352	TYPE 200 AMB V12DAC H1 GY	ELECTRA	60	27645	TWS FLASH YEL V12/48DC BK	AUTOMAX	154
26353	TYPE 200 RED V12DAC H1 GY	ELECTRA	60	27646	TWS FLASH CLR V12/48DC BK	AUTOMAX	154
26354	TYPE 200 GRE V12DAC H1 GY	ELECTRA	60	27651	TWS FLASH BLU V24/240AC BK	AUTOMAX	154
26355	TYPE 200 YEL V12DAC H1 GY	ELECTRA	60	27652	TWS FLASH AMB V24/240AC BK	AUTOMAX	154
26362	TYPE 200 AMB V24DAC H1 GY	ELECTRA	60	27653	TWS FLASH RED V24/240AC BK	AUTOMAX	154
26363	TYPE 200 RED V24DAC H1 GY	ELECTRA	60	27654	TWS FLASH GRE V24/240AC BK	AUTOMAX	154
26364	TYPE 200 GRE V24DAC H1 GY	ELECTRA	60	27655	TWS FLASH YEL V24/240AC BK	AUTOMAX	154
26365	TYPE 200 YEL V24DAC H1 GY	ELECTRA	60	27656	TWS FLASH CLR V24/240AC BK	AUTOMAX	154
26382	TYPE 200 AMB V110AC H1 GY	ELECTRA	60	27661	TWS XENON BLU V24DAC BK	AUTOMAX	155
26383	TYPE 200 RED V110AC H1 GY	ELECTRA	60	27662	TWS XENON AMB V24DAC BK	AUTOMAX	155
26384	TYPE 200 GRE V110AC H1 GY	ELECTRA	60	27663	TWS XENON RED V24DAC BK	AUTOMAX	155
26385	TYPE 200 YEL V110AC H1 GY	ELECTRA	60	27664	TWS XENON GRE V24DAC BK	AUTOMAX	155
26392	TYPE 200 AMB V240AC H1 GY	ELECTRA	60	27665	TWS XENON YEL V24DAC BK	AUTOMAX	155
26393	TYPE 200 RED V240AC H1 GY	ELECTRA	60	27666	TWS XENON CLR V24DAC BK	AUTOMAX	155
26394	TYPE 200 GRE V240AC H1 GY	ELECTRA	60	27671	TWS XENON BLU V110AC BK	AUTOMAX	155
26395	TYPE 200 YEL V240AC H1 GY	ELECTRA	60	27672	TWS XENON AMB V110AC BK	AUTOMAX	155
27139	CTL900 X A BLU V240AC GY	ELECTRA	39	27673	TWS XENON RED V110AC BK	AUTOMAX	155
27140	CTL900 X A AMB V240AC GY	ELECTRA	39	27674	TWS XENON GRE V110AC BK	AUTOMAX	155
27141	CTL900 X A RED V240AC GY	ELECTRA	39	27675	TWS XENON YEL V110AC BK	AUTOMAX	155
27142	CTL900 X A GRE V240AC GY	ELECTRA	39	27676	TWS XENON CLR V110AC BK	AUTOMAX	155
27143	CTL900 X A YEL V240AC GY	ELECTRA	39	27677	TWS HD SS ENCLOSURE (3)	AUTOMAX	157

Code	Description	Section	Page	Code	Description	Section	Page
27678	TWS HD SS POLE MOUNTER	AUTOMAX	157	27755	TWS XENON YEL V240AC GY	AUTOMAX	155
27679	TWS HD SS FLAT MOUNTER	AUTOMAX	157	27756	TWS XENON CLR V240AC GY	AUTOMAX	155
27680	TWS HD SS WALL MOUNTER	AUTOMAX	157	27760	TWS BASE FOOT (BS) GY	AUTOMAX	165
27681	TWS XENON BLU V240AC BK	AUTOMAX	155	27761	TWS EXTENSION L10 GY	AUTOMAX	165
27682	TWS XENON AMB V240AC BK	AUTOMAX	155	27762	TWS WALL MOUNT (BP1) GY	ELECTRA/AUTOMAX	45/165
27683	TWS XENON RED V240AC BK	AUTOMAX	155	27763	TWS DOUBLE WALL MOUNT (BP2) GY	ELECTRA/AUTOMAX	45/165
27684	TWS XENON GRE V240AC BK	AUTOMAX	155	27764	TWS EXTENDED FOOT L10 GY	ELECTRA/AUTOMAX	45/165
27685	TWS XENON YEL V240AC BK	AUTOMAX	155	27765	KIT SS L10 GY	AUTOMAX	165
27686	TWS XENON CLR V240AC BK	AUTOMAX	155	27766	KIT SS L20 GY	AUTOMAX	165
27690	TWS WIRING BASE BK	AUTOMAX	150	27767	KIT SS L40 GY	AUTOMAX	165
27691	TWS BASE FOOT (BS) BK	AUTOMAX	165	27777	TWS M16 CONNECTION BOX GY	AUTOMAX	165
27692	TWS EXTENSION L10 BK	AUTOMAX	165	27778	TWS M16 CONNECTION BOX BK	AUTOMAX	165
27693	TWS WALL MOUNT (BP1) BK	AUTOMAX	165	27780	BULB BA15D 5W V12 25PCS	ELECTRA/AUTOMAX	84/164
27694	TWS DOUBLE WALL MOUNT (BP2) BK	AUTOMAX	165	27781	BULB BA15D 5W V24 25PCS	ELECTRA/AUTOMAX	84/164
27695	TWS EXTENDED FOOT L10 BK	AUTOMAX	165	27782	BULB BA15D 5W V48 25PCS	ELECTRA/AUTOMAX	84/164
27697	OVOLUX MOUNTING ADAPTER GY	ELECTRA	45	27783	BULB BA15D 5W V130 25PCS	ELECTRA/AUTOMAX	84/164
27700	TWS WIRING BASE GY	AUTOMAX	150	27784	BULB BA15D 5W V240 25PCS	ELECTRA/AUTOMAX	84/164
27701	TWS STEADY BLU V12/240DAC GY	AUTOMAX	154	27785	BULB BA15D 10W V12 25PCS	ELECTRA	84
27702	TWS STEADY AMB V12/240DAC GY	AUTOMAX	154	27786	BULB BA15D 10W V24 25PCS	ELECTRA	84
27703	TWS STEADY RED V12/240DAC GY	AUTOMAX	154	27787	BULB BA15D 10W V48 25PCS	ELECTRA	84
27704	TWS STEADY GRE V12/240DAC GY	AUTOMAX	154	27788	BULB BA15D 10W V130 25PCS	ELECTRA	84
27705	TWS STEADY YEL V12/240DAC GY	AUTOMAX	154	27789	BULB BA15D 10W V240 25PCS	ELECTRA	84
27706	TWS STEADY CLR V12/240DAC GY	AUTOMAX	154	27790	TWS SOUNDER MDA V12/24DAC GY	AUTOMAX	156
27711	TWS FLASH BLU V12/48DC GY	AUTOMAX	154	27791	TWS SOUNDER MDA V48AC GY	AUTOMAX	156
27712	TWS FLASH AMB V12/48DC GY	AUTOMAX	154	27792	TWS SOUNDER MDA V110AC GY	AUTOMAX	156
27713	TWS FLASH RED V12/48DC GY	AUTOMAX	154	27793	TWS SOUNDER MDA V240AC GY	AUTOMAX	156
27714	TWS FLASH GRE V12/48DC GY	AUTOMAX	154	27794	TWS SOUNDER MDA V12/24DAC BK	AUTOMAX	156
27715	TWS FLASH YEL V12/48DC GY	AUTOMAX	154	27795	TWS SOUNDER MDA V48AC BK	AUTOMAX	156
27716	TWS FLASH CLR V12/48DC GY	AUTOMAX	154	27796	TWS SOUNDER MDA V110AC BK	AUTOMAX	156
27718	TWS SOUNDER PZ V12/48DAC GY	AUTOMAX	156	27797	TWS SOUNDER MDA V240AC BK	AUTOMAX	156
27719	TWS SOUNDER PZ V110/240AC GY	AUTOMAX	156	27801	LD 103 EXL BA15D V24 DCAC1	ELECTRA	86
27721	TWS FLASH BLU V24/240AC GY	AUTOMAX	154	27802	LD 103 BA15D V24 DCAC2	ELECTRA	86
27722	TWS FLASH AMB V24/240AC GY	AUTOMAX	154	27803	LD 103 BA15D V24 DCAC3	ELECTRA	86
27723	TWS FLASH RED V24/240AC GY	AUTOMAX	154	27805	LD 103 BA15D V24 DCAC5	ELECTRA	86
27724	TWS FLASH GRE V24/240AC GY	AUTOMAX	154	27806	LD 103 BA15D V24 DCAC6	ELECTRA	86
27725	TWS FLASH YEL V24/240AC GY	AUTOMAX	154	27808	LD 103 EXL BA15D V24 DCAC8	ELECTRA	86
27726	TWS FLASH CLR V24/240AC GY	AUTOMAX	154	27840	TWS HD AL ENCLOSURE (3)	AUTOMAX	157
27731	TWS XENON BLU V24DAC GY	AUTOMAX	155	27841	TWS HD AL FLAT MOUNTER	AUTOMAX	157
27732	TWS XENON AMB V24DAC GY	AUTOMAX	155	27842	TWS HD AL POLE MOUNTER	AUTOMAX	157
27733	TWS XENON RED V24DAC GY	AUTOMAX	155	27843	TWS HD AL WALL MOUNTER	AUTOMAX	157
27734	TWS XENON GRE V24DAC GY	AUTOMAX	155	27845	KIT SS L10 BK	AUTOMAX	165
27735	TWS XENON YEL V24DAC GY	AUTOMAX	155	27846	KIT SS L20 BK	AUTOMAX	165
27736	TWS XENON CLR V24DAC GY	AUTOMAX	155	27847	KIT SS L40 BK	AUTOMAX	165
27741	TWS XENON BLU V110AC GY	AUTOMAX	155	27941	LD 145 F EXL E27 V12 DCAC1	ELECTRA	85
27742	TWS XENON AMB V110AC GY	AUTOMAX	155	27942	LD 145 F EXL E27 V12 DCAC2	ELECTRA	85
27743	TWS XENON RED V110AC GY	AUTOMAX	155	27943	LD 145 F EXL E27 V12 DCAC3	ELECTRA	85
27744	TWS XENON GRE V110AC GY	AUTOMAX	155	27945	LD 145 F EXL E27 V12 DCAC5	ELECTRA	85
27745	TWS XENON YEL V110AC GY	AUTOMAX	155	27946	LD 145 F EXL E27 V12 DCAC6	ELECTRA	85
27746	TWS XENON CLR V110AC GY	AUTOMAX	155	27948	LD 145 F EXL E27 V12 DCAC8	ELECTRA	85
27751	TWS XENON BLU V240AC GY	AUTOMAX	155	27951	LD 145 F EXL E27 V24 DCAC1	ELECTRA	85
27752	TWS XENON AMB V240AC GY	AUTOMAX	155	27952	LD 145 F EXL E27 V24 DCAC2	ELECTRA	85
27753	TWS XENON RED V240AC GY	AUTOMAX	155	27953	LD 145 F EXL E27 V24 DCAC3	ELECTRA	85
27754	TWS XENON GRE V240AC GY	AUTOMAX	155	27955	LD 145 F EXL E27 V24 DCAC5	ELECTRA	85

Code	Description	Section	Page	Code	Description	Section	Page
27956	LD 145 F EXL E27 V24 DCAC6	ELECTRA	85	28545	LD 145 F EXL E14 V24 DCAC5	ELECTRA	85
27958	LD 145 F EXL E27 V24 DCAC8	ELECTRA	85	28546	LD 145 F EXL E14 V24 DCAC6	ELECTRA	85
27991	LD 205 EXL BA15D V24 DCAC1	ELECTRA	86	28548	LD 145 F EXL E14 V24 DCAC8	ELECTRA	85
27992	LD 205 EXL BA15D V24 DCAC2	ELECTRA	86	28551	LD 145 F EXL E14 V48 DCAC1	ELECTRA	85
27993	LD 205 EXL BA15D V24 DCAC3	ELECTRA	86	28552	LD 145 F EXL E14 V48 DCAC2	ELECTRA	85
27995	LD 205 EXL BA15D V24 DCAC5	ELECTRA	86	28553	LD 145 F EXL E14 V48 DCAC3	ELECTRA	85
27996	LD 205 EXL BA15D V24 DCAC6	ELECTRA	86	28555	LD 145 F EXL E14 V48 DCAC5	ELECTRA	85
27998	LD 205 EXL BA15D V24 DCAC8	ELECTRA	86	28556	LD 145 F EXL E14 V48 DCAC6	ELECTRA	85
28431	LD 205 EXL E14 V12 DCAC1	ELECTRA	86	28558	LD 145 F EXL E14 V48 DCAC8	ELECTRA	85
28432	LD 205 EXL E14 V12 DCAC2	ELECTRA	86	28561	LD 145 F EXL E14 V110 AC1	ELECTRA	85
28433	LD 205 EXL E14 V12 DCAC3	ELECTRA	86	28562	LD 145 F EXL E14 V110 AC2	ELECTRA	85
28435	LD 205 EXL E14 V12 DCAC5	ELECTRA	86	28563	LD 145 F EXL E14 V110 AC3	ELECTRA	85
28436	LD 205 EXL E14 V12 DCAC6	ELECTRA	86	28565	LD 145 F EXL E14 V110 AC5	ELECTRA	85
28438	LD 205 EXL E14 V12 DCAC8	ELECTRA	86	28566	LD 145 F EXL E14 V110 AC6	ELECTRA	85
28441	LD 205 EXL E14 V24 DCAC1	ELECTRA	86	28568	LD 145 F EXL E14 V110 AC8	ELECTRA	85
28442	LD 205 EXL E14 V24 DCAC2	ELECTRA	86	28571	LD 145 F EXL E14 V240 AC1	ELECTRA	85
28443	LD 205 EXL E14 V24 DCAC3	ELECTRA	86	28572	LD 145 F EXL E14 V240 AC2	ELECTRA	85
28445	LD 205 EXL E14 V24 DCAC5	ELECTRA	86	28573	LD 145 F EXL E14 V240 AC3	ELECTRA	85
28446	LD 205 EXL E14 V24 DCAC6	ELECTRA	86	28575	LD 145 F EXL E14 V240 AC5	ELECTRA	85
28448	LD 205 EXL E14 V24 DCAC8	ELECTRA	86	28576	LD 145 F EXL E14 V240 AC6	ELECTRA	85
28451	LD 205 EXL E14 V48 DCAC1	ELECTRA	86	28578	LD 145 F EXL E14 V240 AC8	ELECTRA	85
28452	LD 205 EXL E14 V48 DCAC2	ELECTRA	86	28881	LD 145 F EXL E27 V240 AC1	ELECTRA	85
28453	LD 205 EXL E14 V48 DCAC3	ELECTRA	86	28882	LD 145 F EXL E27 V240 AC2	ELECTRA	85
28455	LD 205 EXL E14 V48 DCAC5	ELECTRA	86	28883	LD 145 F EXL E27 V240 AC3	ELECTRA	85
28456	LD 205 EXL E14 V48 DCAC6	ELECTRA	86	28885	LD 145 F EXL E27 V240 AC5	ELECTRA	85
28458	LD 205 EXL E14 V48 DCAC8	ELECTRA	86	28886	LD 145 F EXL E27 V240 AC6	ELECTRA	85
28461	LD 205 EXL E14 V110 AC1	ELECTRA	86	28888	LD 145 F EXL E27 V240 AC8	ELECTRA	85
28462	LD 205 EXL E14 V110 AC2	ELECTRA	86	29301	LD 145 F EXL E27 V48 DCAC1	ELECTRA	85
28463	LD 205 EXL E14 V110 AC3	ELECTRA	86	29302	LD 145 F EXL E27 V48 DCAC2	ELECTRA	85
28465	LD 205 EXL E14 V110 AC5	ELECTRA	86	29303	LD 145 F EXL E27 V48 DCAC3	ELECTRA	85
28466	LD 205 EXL E14 V110 AC6	ELECTRA	86	29305	LD 145 F EXL E27 V48 DCAC5	ELECTRA	85
28468	LD 205 EXL E14 V110 AC8	ELECTRA	86	29306	LD 145 F EXL E27 V48 DCAC6	ELECTRA	85
28471	LD 205 EXL E14 V240 AC1	ELECTRA	86	29308	LD 145 F EXL E27 V48 DCAC8	ELECTRA	85
28472	LD 205 EXL E14 V240 AC2	ELECTRA	86	29491	LD 103 EXL BA15D V12 DCAC1	ELECTRA	86
28473	LD 205 EXL E14 V240 AC3	ELECTRA	86	29492	LD 103 BA15D V12 DCAC2	ELECTRA	86
28475	LD 205 EXL E14 V240 AC5	ELECTRA	86	29493	LD 103 BA15D V12 DCAC3	ELECTRA	86
28476	LD 205 EXL E14 V240 AC6	ELECTRA	86	29495	LD 103 BA15D V12 DCAC5	ELECTRA	86
28478	LD 205 EXL E14 V240 AC8	ELECTRA	86	29496	LD 103 BA15D V12 DCAC6	ELECTRA	86
28491	LD 145 F EXL E27 V110 AC1	ELECTRA	85	29498	LD 103 EXL BA15D V12 DCAC8	ELECTRA	86
28492	LD 145 F EXL E27 V110 AC2	ELECTRA	85	29501	LD 103 EXL BA15D V48 DCAC1	ELECTRA	86
28493	LD 145 F EXL E27 V110 AC3	ELECTRA	85	29502	LD 103 BA15D V48 DCAC2	ELECTRA	86
28495	LD 145 F EXL E27 V110 AC5	ELECTRA	85	29503	LD 103 BA15D V48 DCAC3	ELECTRA	86
28496	LD 145 F EXL E27 V110 AC6	ELECTRA	85	29505	LD 103 BA15D V48 DCAC5	ELECTRA	86
28498	LD 145 F EXL E27 V110 AC8	ELECTRA	85	29506	LD 103 BA15D V48 DCAC6	ELECTRA	86
28531	LD 145 F EXL E14 V12 DCAC1	ELECTRA	85	29508	LD 103 EXL BA15D V48 DCAC8	ELECTRA	86
28532	LD 145 F EXL E14 V12 DCAC2	ELECTRA	85	29511	LD 103 EXL BA15D V110 AC1	ELECTRA	86
28533	LD 145 F EXL E14 V12 DCAC3	ELECTRA	85	29512	LD 103 BA15D V110 AC2	ELECTRA	86
28535	LD 145 F EXL E14 V12 DCAC5	ELECTRA	85	29513	LD 103 BA15D V110 AC3	ELECTRA	86
28536	LD 145 F EXL E14 V12 DCAC6	ELECTRA	85	29515	LD 103 BA15D V110 AC5	ELECTRA	86
28538	LD 145 F EXL E14 V12 DCAC8	ELECTRA	85	29516	LD 103 BA15D V110 AC6	ELECTRA	86
28541	LD 145 F EXL E14 V24 DCAC1	ELECTRA	85	29518	LD 103 EXL BA15D V110 AC8	ELECTRA	86
28542	LD 145 F EXL E14 V24 DCAC2	ELECTRA	85	29521	LD 103 EXL BA15D V240 AC1	ELECTRA	86
28543	LD 145 F EXL E14 V24 DCAC3	ELECTRA	85	29522	LD 103 BA15D V240 AC2	ELECTRA	86

Code	Description	Section	Page	Code	Description	Section	Page
29523	LD 103 BA15D V240 AC3	ELECTRA	86	29822	LD 145 F EXLBA15DV240 AC2	ELECTRA	85
29525	LD 103 BA15D V240 AC5	ELECTRA	86	29823	LD 145 F EXLBA15DV240 AC3	ELECTRA	85
29526	LD 103 BA15D V240 AC6	ELECTRA	86	29825	LD 145 F EXLBA15DV240 AC5	ELECTRA	85
29528	LD 103 EXL BA15D V240 AC8	ELECTRA	86	29826	LD 145 F EXLBA15DV240 AC6	ELECTRA	85
29691	LD 205 EXL BA15D V12 DCAC1	ELECTRA	86	29828	LD 145 F EXLBA15DV240 AC8	ELECTRA	85
29692	LD 205 EXL BA15D V12 DCAC2	ELECTRA	86	30011	OVOLUX STY BLU R V12/240DAC GY	ELECTRA	43
29693	LD 205 EXL BA15D V12 DCAC3	ELECTRA	86	30012	OVOLUX STY AMB R V12/240DAC GY	ELECTRA	43
29695	LD 205 EXL BA15D V12 DCAC5	ELECTRA	86	30013	OVOLUX STY RED R V12/240DAC GY	ELECTRA	43
29696	LD 205 EXL BA15D V12 DCAC6	ELECTRA	86	30014	OVOLUX STY GRE R V12/240DAC GY	ELECTRA	43
29698	LD 205 EXL BA15D V12 DCAC8	ELECTRA	86	30015	OVOLUX STY YEL R V12/240DAC GY	ELECTRA	43
29701	LD 205 EXL BA15D V48 DCAC1	ELECTRA	86	30016	OVOLUX STY CLR R V12/240DAC GY	ELECTRA	43
29702	LD 205 EXL BA15D V48 DCAC2	ELECTRA	86	30031	OVOLUX STY BLU M V12/240DAC GY	ELECTRA	43
29703	LD 205 EXL BA15D V48 DCAC3	ELECTRA	86	30032	OVOLUX STY AMB M V12/240DAC GY	ELECTRA	43
29705	LD 205 EXL BA15D V48 DCAC5	ELECTRA	86	30033	OVOLUX STY RED M V12/240DAC GY	ELECTRA	43
29706	LD 205 EXL BA15D V48 DCAC6	ELECTRA	86	30034	OVOLUX STY GRE M V12/240DAC GY	ELECTRA	43
29708	LD 205 EXL BA15D V48 DCAC8	ELECTRA	86	30035	OVOLUX STY YEL M V12/240DAC GY	ELECTRA	43
29711	LD 205 EXL BA15D V110 AC1	ELECTRA	86	30036	OVOLUX STY CLR M V12/240DAC GY	ELECTRA	43
29712	LD 205 EXL BA15D V110 AC2	ELECTRA	86	30051	OVOLUX FLA BLU R V12/48DC GY	ELECTRA	43
29713	LD 205 EXL BA15D V110 AC3	ELECTRA	86	30052	OVOLUX FLA AMB R V12/48DC GY	ELECTRA	43
29715	LD 205 EXL BA15D V110 AC5	ELECTRA	86	30053	OVOLUX FLA RED R V12/48DC GY	ELECTRA	43
29716	LD 205 EXL BA15D V110 AC6	ELECTRA	86	30054	OVOLUX FLA GRE R V12/48DC GY	ELECTRA	43
29718	LD 205 EXL BA15D V110 AC8	ELECTRA	86	30055	OVOLUX FLA YEL R V12/48DC GY	ELECTRA	43
29721	LD 205 EXL BA15D V240 AC1	ELECTRA	86	30056	OVOLUX FLA CLR R V12/48DC GY	ELECTRA	43
29722	LD 205 EXL BA15D V240 AC2	ELECTRA	86	30071	OVOLUX FLA BLU M V12/48DC GY	ELECTRA	43
29723	LD 205 EXL BA15D V240 AC3	ELECTRA	86	30072	OVOLUX FLA AMB M V12/48DC GY	ELECTRA	43
29725	LD 205 EXL BA15D V240 AC5	ELECTRA	86	30073	OVOLUX FLA RED M V12/48DC GY	ELECTRA	43
29726	LD 205 EXL BA15D V240 AC6	ELECTRA	86	30074	OVOLUX FLA GRE M V12/48DC GY	ELECTRA	43
29728	LD 205 EXL BA15D V240 AC8	ELECTRA	86	30075	OVOLUX FLA YEL M V12/48DC GY	ELECTRA	43
29781	LD 145 F EXLBA15DV12 DCAC1	ELECTRA	85	30076	OVOLUX FLA CLR M V12/48DC GY	ELECTRA	43
29782	LD 145 F EXLBA15DV12 DCAC2	ELECTRA	85	30091	OVOLUX FLA BLU R V24/240AC GY	ELECTRA	43
29783	LD 145 F EXLBA15DV12 DCAC3	ELECTRA	85	30092	OVOLUX FLA AMB R V24/240AC GY	ELECTRA	43
29785	LD 145 F EXLBA15DV12 DCAC5	ELECTRA	85	30093	OVOLUX FLA RED R V24/240AC GY	ELECTRA	43
29786	LD 145 F EXLBA15DV12 DCAC6	ELECTRA	85	30094	OVOLUX FLA GRE R V24/240AC GY	ELECTRA	43
29788	LD 145 F EXLBA15DV12 DCAC8	ELECTRA	85	30095	OVOLUX FLA YEL R V24/240AC GY	ELECTRA	43
29791	LD 145 F EXLBA15DV24 DCAC1	ELECTRA	85	30096	OVOLUX FLA CLR R V24/240AC GY	ELECTRA	43
29792	LD 145 F EXLBA15DV24 DCAC2	ELECTRA	85	30107	OVOLUX LED RGB R V12/24DAC GY	ELECTRA	42
29793	LD 145 F EXLBA15DV24 DCAC3	ELECTRA	85	30108	OVOLUX LED RGB R V90/240AC GY	ELECTRA	42
29795	LD 145 F EXLBA15DV24 DCAC5	ELECTRA	85	30111	OVOLUX FLA BLU M V24/240AC GY	ELECTRA	43
29796	LD 145 F EXLBA15DV24 DCAC6	ELECTRA	85	30112	OVOLUX FLA AMB M V24/240AC GY	ELECTRA	43
29798	LD 145 F EXLBA15DV24 DCAC8	ELECTRA	85	30113	OVOLUX FLA RED M V24/240AC GY	ELECTRA	43
29801	LD 145 F EXLBA15DV48 DCAC1	ELECTRA	85	30114	OVOLUX FLA GRE M V24/240AC GY	ELECTRA	43
29802	LD 145 F EXLBA15DV48 DCAC2	ELECTRA	85	30115	OVOLUX FLA YEL M V24/240AC GY	ELECTRA	43
29803	LD 145 F EXLBA15DV48 DCAC3	ELECTRA	85	30116	OVOLUX FLA CLR M V24/240AC GY	ELECTRA	43
29805	LD 145 F EXLBA15DV48 DCAC5	ELECTRA	85	30131	OVOLUX X BLU R V24DAC GY	ELECTRA	43
29806	LD 145 F EXLBA15DV48 DCAC6	ELECTRA	85	30132	OVOLUX X AMB R V24DAC GY	ELECTRA	43
29808	LD 145 F EXLBA15DV48 DCAC8	ELECTRA	85	30133	OVOLUX X RED R V24DAC GY	ELECTRA	43
29811	LD 145 F EXLBA15DV110 AC1	ELECTRA	85	30134	OVOLUX X GRE R V24DAC GY	ELECTRA	43
29812	LD 145 F EXLBA15DV110 AC2	ELECTRA	85	30135	OVOLUX X YEL R V24DAC GY	ELECTRA	43
29813	LD 145 F EXLBA15DV110 AC3	ELECTRA	85	30136	OVOLUX X CLR R V24DAC GY	ELECTRA	43
29815	LD 145 F EXLBA15DV110 AC5	ELECTRA	85	30151	OVOLUX X BLU M V24DAC GY	ELECTRA	43
29816	LD 145 F EXLBA15DV110 AC6	ELECTRA	85	30152	OVOLUX X AMB M V24DAC GY	ELECTRA	43
29818	LD 145 F EXLBA15DV110 AC8	ELECTRA	85	30153	OVOLUX X RED M V24DAC GY	ELECTRA	43
29821	LD 145 F EXLBA15DV240 AC1	ELECTRA	85	30154	OVOLUX X GRE M V24DAC GY	ELECTRA	43

Code	Description	Section	Page	Code	Description	Section	Page
30155	OVOLUX X YEL M V24DAC GY	ELECTRA	43	31541	MINITWS BLU S/F CO V24DAC BK	AUTOMAX	161
30156	OVOLUX X CLR M V24DAC GY	ELECTRA	43	31542	MINITWS AMB S/F CO V24DAC BK	AUTOMAX	161
30171	OVOLUX X BLU R V110AC GY	ELECTRA	43	31543	MINITWS RED S/F CO V24DAC BK	AUTOMAX	161
30172	OVOLUX X AMB R V110AC GY	ELECTRA	43	31544	MINITWS GRE S/F CO V24DAC BK	AUTOMAX	161
30173	OVOLUX X RED R V110AC GY	ELECTRA	43	31545	MINITWS YEL S/F CO V24DAC BK	AUTOMAX	161
30174	OVOLUX X GRE R V110AC GY	ELECTRA	43	31546	MINITWS CLR S/F V24DAC BK	AUTOMAX	161
30175	OVOLUX X YEL R V110AC GY	ELECTRA	43	31551	MINITWS BLU S/F CO V110AC BK	AUTOMAX	161
30176	OVOLUX X CLR R V110AC GY	ELECTRA	43	31552	MINITWS AMB S/F CO V110AC BK	AUTOMAX	161
30191	OVOLUX X BLU M V110AC GY	ELECTRA	43	31553	MINITWS RED S/F CO V110AC BK	AUTOMAX	161
30192	OVOLUX X AMB M V110AC GY	ELECTRA	43	31554	MINITWS GRE S/F CO V110AC BK	AUTOMAX	161
30193	OVOLUX X RED M V110AC GY	ELECTRA	43	31555	MINITWS YEL S/F CO V110AC BK	AUTOMAX	161
30194	OVOLUX X GRE M V110AC GY	ELECTRA	43	31556	MINITWS CLR S/F V110AC BK	AUTOMAX	161
30195	OVOLUX X YEL M V110AC GY	ELECTRA	43	31561	MINITWS BLU S/F CO V240AC BK	AUTOMAX	161
30196	OVOLUX X CLR M V110AC GY	ELECTRA	43	31562	MINITWS AMB S/F CO V240AC BK	AUTOMAX	161
30211	OVOLUX X BLU R V240AC GY	ELECTRA	43	31563	MINITWS RED S/F CO V240AC BK	AUTOMAX	161
30212	OVOLUX X AMB R V240AC GY	ELECTRA	43	31564	MINITWS GRE S/F CO V240AC BK	AUTOMAX	161
30213	OVOLUX X RED R V240AC GY	ELECTRA	43	31565	MINITWS YEL S/F CO V240AC BK	AUTOMAX	161
30214	OVOLUX X GRE R V240AC GY	ELECTRA	43	31566	MINITWS CLR S/F V240AC BK	AUTOMAX	161
30215	OVOLUX X YEL R V240AC GY	ELECTRA	43	32201	TWS LED BLU S PR V24DAC GY	AUTOMAX	151
30216	OVOLUX X CLR R V240AC GY	ELECTRA	43	32202	TWS LED AMB S PR V24DAC GY	AUTOMAX	151
30231	OVOLUX X BLU M V240AC GY	ELECTRA	43	32203	TWS LED RED S PR V24DAC GY	AUTOMAX	151
30232	OVOLUX X AMB M V240AC GY	ELECTRA	43	32204	TWS LED GRE S PR V24DAC GY	AUTOMAX	151
30233	OVOLUX X RED M V240AC GY	ELECTRA	43	32205	TWS LED YEL S PR V24DAC GY	AUTOMAX	151
30234	OVOLUX X GRE M V240AC GY	ELECTRA	43	32206	TWS LED CLR S PR V24DAC GY	AUTOMAX	151
30235	OVOLUX X YEL M V240AC GY	ELECTRA	43	32211	TWS LED BLU S PR V110AC GY	AUTOMAX	151
30236	OVOLUX X CLR M V240AC GY	ELECTRA	43	32212	TWS LED AMB S PR V110AC GY	AUTOMAX	151
31302	OVOLUX SPARE DOME CLR OPALINE	ELECTRA	42	32213	TWS LED RED S PR V110AC GY	AUTOMAX	151
31500	MINITWS WIRING BASE GY	AUTOMAX	161	32214	TWS LED GRE S PR V110AC GY	AUTOMAX	151
31501	MINITWS BLU S/F CO V24DAC GY	AUTOMAX	161	32215	TWS LED YEL S PR V110AC GY	AUTOMAX	151
31502	MINITWS AMB S/F CO V24DAC GY	AUTOMAX	161	32216	TWS LED CLR S PR V110AC GY	AUTOMAX	151
31503	MINITWS RED S/F CO V24DAC GY	AUTOMAX	161	32221	TWS LED BLU S PR V240AC GY	AUTOMAX	151
31504	MINITWS GRE S/F CO V24DAC GY	AUTOMAX	161	32222	TWS LED AMB S PR V240AC GY	AUTOMAX	151
31505	MINITWS YEL S/F CO V24DAC GY	AUTOMAX	161	32223	TWS LED RED S PR V240AC GY	AUTOMAX	151
31506	MINITWS CLR S/F V24DAC GY	AUTOMAX	161	32224	TWS LED GRE S PR V240AC GY	AUTOMAX	151
31508	MINITWS WIRING BASE BK	AUTOMAX	161	32225	TWS LED YEL S PR V240AC GY	AUTOMAX	151
31511	MINITWS BLU S/F CO V110AC GY	AUTOMAX	161	32226	TWS LED CLR S PR V240AC GY	AUTOMAX	151
31512	MINITWS AMB S/F CO V110AC GY	AUTOMAX	161	32231	TWS LED BLU S PR V24DAC BK	AUTOMAX	151
31513	MINITWS RED S/F CO V110AC GY	AUTOMAX	161	32232	TWS LED AMB S PR V24DAC BK	AUTOMAX	151
31514	MINITWS GRE S/F CO V110AC GY	AUTOMAX	161	32233	TWS LED RED S PR V24DAC BK	AUTOMAX	151
31515	MINITWS YEL S/F CO V110AC GY	AUTOMAX	161	32234	TWS LED GRE S PR V24DAC BK	AUTOMAX	151
31516	MINITWS CLR S/F V110AC GY	AUTOMAX	161	32235	TWS LED YEL S PR V24DAC BK	AUTOMAX	151
31521	MINITWS BLU S/F CO V240AC GY	AUTOMAX	161	32236	TWS LED CLR S PR V24DAC BK	AUTOMAX	151
31522	MINITWS AMB S/F CO V240AC GY	AUTOMAX	161	32241	TWS LED BLU S PR V110AC BK	AUTOMAX	151
31523	MINITWS RED S/F CO V240AC GY	AUTOMAX	161	32242	TWS LED AMB S PR V110AC BK	AUTOMAX	151
31524	MINITWS GRE S/F CO V240AC GY	AUTOMAX	161	32243	TWS LED RED S PR V110AC BK	AUTOMAX	151
31525	MINITWS YEL S/F CO V240AC GY	AUTOMAX	161	32244	TWS LED GRE S PR V110AC BK	AUTOMAX	151
31526	MINITWS CLR S/F V240AC GY	AUTOMAX	161	32245	TWS LED YEL S PR V110AC BK	AUTOMAX	151
31531	MINITWS SOUNDER V24DAC GY	AUTOMAX	161	32246	TWS LED CLR S PR V110AC BK	AUTOMAX	151
31532	MINITWS SOUNDER V110AC GY	AUTOMAX	161	32251	TWS LED BLU S PR V240AC BK	AUTOMAX	151
31533	MINITWS SOUNDER V240AC GY	AUTOMAX	161	32252	TWS LED AMB S PR V240AC BK	AUTOMAX	151
31534	MINITWS SOUNDER V24DAC BK	AUTOMAX	161	32253	TWS LED RED S PR V240AC BK	AUTOMAX	151
31535	MINITWS SOUNDER V110AC BK	AUTOMAX	161	32254	TWS LED GRE S PR V240AC BK	AUTOMAX	151
31536	MINITWS SOUNDER V240AC BK	AUTOMAX	161	32255	TWS LED YEL S PR V240AC BK	AUTOMAX	151

Code	Description	Section	Page	Code	Description	Section	Page
32256	TWS LED CLR S PR V240AC BK	AUTOMAX	151	32345	ELYPS LM YELLOW ALLCLEAR	AUTOMAX	139
32261	TWS LED BLU M PR V24DAC GY	AUTOMAX	151	32347	ELYPS AM S GY	AUTOMAX	143
32262	TWS LED AMB M PR V24DAC GY	AUTOMAX	151	32348	ELYPS AM S BK	AUTOMAX	143
32263	TWS LED RED M PR V24DAC GY	AUTOMAX	151	32351	ELYPS LM X MLT BLUE	AUTOMAX	142
32264	TWS LED GRE M PR V24DAC GY	AUTOMAX	151	32352	ELYPS LM X MLT AMBER	AUTOMAX	142
32265	TWS LED YEL M PR V24DAC GY	AUTOMAX	151	32353	ELYPS LM X MLT RED	AUTOMAX	142
32266	TWS LED CLR M PR V24DAC GY	AUTOMAX	151	32354	ELYPS LM X MLT GREEN	AUTOMAX	142
32271	TWS LED BLU M PR V110AC GY	AUTOMAX	151	32355	ELYPS LM X MLT YELLOW	AUTOMAX	142
32272	TWS LED AMB M PR V110AC GY	AUTOMAX	151	32356	ELYPS LM X MLT CLEAR	AUTOMAX	142
32273	TWS LED RED M PR V110AC GY	AUTOMAX	151	32357	ELYPS MB FLAT BASE GY	AUTOMAX	144
32274	TWS LED GRE M PR V110AC GY	AUTOMAX	151	32358	ELYPS MB FLAT BASE BK	AUTOMAX	144
32275	TWS LED YEL M PR V110AC GY	AUTOMAX	151	32367	ELYPS MB WALL BASE GY	AUTOMAX	144
32276	TWS LED CLR M PR V110AC GY	AUTOMAX	151	32368	ELYPS MB WALL BASE BK	AUTOMAX	144
32281	TWS LED BLU M PR V240AC GY	AUTOMAX	151	32371	ELYPS LM S BLUE ALLCOLOR	AUTOMAX	140
32282	TWS LED AMB M PR V240AC GY	AUTOMAX	151	32372	ELYPS LM S AMBER ALLCOLOR	AUTOMAX	140
32283	TWS LED RED M PR V240AC GY	AUTOMAX	151	32373	ELYPS LM S RED ALLCOLOR	AUTOMAX	140
32284	TWS LED GRE M PR V240AC GY	AUTOMAX	151	32374	ELYPS LM S GREEN ALLCOLOR	AUTOMAX	140
32285	TWS LED YEL M PR V240AC GY	AUTOMAX	151	32375	ELYPS LM S YELLOW ALLCOLOR	AUTOMAX	140
32286	TWS LED CLR M PR V240AC GY	AUTOMAX	151	32376	ELYPS LM S CLEAR	AUTOMAX	140
32291	TWS LED BLU M PR V24DAC BK	AUTOMAX	151	32377	ELYPS MB EXTENDED BASE GY	AUTOMAX	144
32292	TWS LED AMB M PR V24DAC BK	AUTOMAX	151	32378	ELYPS MB EXTENDED BASE BK	AUTOMAX	144
32293	TWS LED RED M PR V24DAC BK	AUTOMAX	151	32381	ELYPS LM S BLUE ALLCLEAR	AUTOMAX	140
32294	TWS LED GRE M PR V24DAC BK	AUTOMAX	151	32382	ELYPS LM S AMBER ALLCLEAR	AUTOMAX	140
32295	TWS LED YEL M PR V24DAC BK	AUTOMAX	151	32383	ELYPS LM S RED ALLCLEAR	AUTOMAX	140
32296	TWS LED CLR M PR V24DAC BK	AUTOMAX	151	32384	ELYPS LM S GREEN ALLCLEAR	AUTOMAX	140
32301	TWS LED BLU M PR V110AC BK	AUTOMAX	151	32385	ELYPS LM S YELLOW ALLCLEAR	AUTOMAX	140
32302	TWS LED AMB M PR V110AC BK	AUTOMAX	151	32387	ELYPS MB 1/2 NPTF POLE BASE GY	AUTOMAX	144
32303	TWS LED RED M PR V110AC BK	AUTOMAX	151	32388	ELYPS MB 1/2 NPTF POLE BASE BK	AUTOMAX	144
32304	TWS LED GRE M PR V110AC BK	AUTOMAX	151	32391	ELYPS LM S MLT BLUE ALLCOLOR	AUTOMAX	141
32305	TWS LED YEL M PR V110AC BK	AUTOMAX	151	32392	ELYPS LM S MLT AMB ALLCOLOR	AUTOMAX	141
32306	TWS LED CLR M PR V110AC BK	AUTOMAX	151	32393	ELYPS LM S MLT RED ALLCOLOR	AUTOMAX	141
32311	TWS LED BLU M PR V240AC BK	AUTOMAX	151	32394	ELYPS LM S MLT GREEN ALLCOLOR	AUTOMAX	141
32312	TWS LED AMB M PR V240AC BK	AUTOMAX	151	32395	ELYPS LM S MLT YELLOW ALLCOLOR	AUTOMAX	141
32313	TWS LED RED M PR V240AC BK	AUTOMAX	151	32396	ELYPS LM S MLT CLEAR	AUTOMAX	141
32314	TWS LED GRE M PR V240AC BK	AUTOMAX	151	32401	ELYPS LM S MLT BLUE ALLCLEAR	AUTOMAX	141
32315	TWS LED YEL M PR V240AC BK	AUTOMAX	151	32402	ELYPS LM S MLT AMBER ALLCLEAR	AUTOMAX	141
32316	TWS LED CLR M PR V240AC BK	AUTOMAX	151	32403	ELYPS LM S MLT RED ALLCLEAR	AUTOMAX	141
32320	ELYPS WM HT V120/240AC GY	AUTOMAX	138	32404	ELYPS LM S MLT GREEN ALLCLEAR	AUTOMAX	141
32321	ELYPS WM HT V120/240AC BK	AUTOMAX	138	32405	ELYPS LM S MLT YELLOW ALLCLEAR	AUTOMAX	141
32326	ELYPS WM MLT HT V120/240AC GY	AUTOMAX	138	32411	ELYPS LM BLUE PROXIMITY V24DAC	AUTOMAX	139
32327	ELYPS WM MLT HT V120/240AC BK	AUTOMAX	138	32412	ELYPS LM AMBER PROXIMITY V24DAC	AUTOMAX	139
32331	ELYPS LM BLUE ALLCOLOR	AUTOMAX	139	32413	ELYPS LM RED PROXIMITY V24DAC	AUTOMAX	139
32332	ELYPS LM AMBER ALLCOLOR	AUTOMAX	139	32414	ELYPS LM GREEN PROXIMITY V24DAC	AUTOMAX	139
32333	ELYPS LM RED ALLCOLOR	AUTOMAX	139	32415	ELYPS LM YELLOW PROXIMITY V24DAC	AUTOMAX	139
32334	ELYPS LM GREEN ALLCOLOR	AUTOMAX	139	32416	ELYPS LM CLEAR PROXIMITY V24DAC	AUTOMAX	139
32335	ELYPS LM YELLOW ALLCOLOR	AUTOMAX	139	32420	ELYPS MB TUBE BASE GY L100 SS	AUTOMAX	144
32336	ELYPS LM CLEAR	AUTOMAX	139	32421	ELYPS MB TUBE BASE GY L200 SS	AUTOMAX	144
32337	ELYPS AM GY	AUTOMAX	143	32422	ELYPS MB TUBE BASE GY L300 SS	AUTOMAX	144
32338	ELYPS AM BK	AUTOMAX	143	32423	ELYPS MB TUBE BASE GY L400 SS	AUTOMAX	144
32341	ELYPS LM BLUE ALLCLEAR	AUTOMAX	139	32424	ELYPS MB TUBE BASE BK L100 SS	AUTOMAX	144
32342	ELYPS LM AMBER ALLCLEAR	AUTOMAX	139	32425	ELYPS MB TUBE BASE BK L200 SS	AUTOMAX	144
32343	ELYPS LM RED ALLCLEAR	AUTOMAX	139	32426	ELYPS MB TUBE BASE BK L300 SS	AUTOMAX	144
32344	ELYPS LM GREEN ALLCLEAR	AUTOMAX	139	32427	ELYPS MB TUBE BASE BK L400 SS	AUTOMAX	144

Code	Description	Section	Page	Code	Description	Section	Page
32451	ELYPS LM BLUE ALLCLEAR V12DAC	AUTOMAX	139	32753	LDESEXLBA9S(1X10)V240 AC3	ELECTRA	85
32452	ELYPS LM AMBER ALLCLEAR V12DAC	AUTOMAX	139	32755	LDESEXLBA9S(1X10)V240 AC5	ELECTRA	85
32453	ELYPS LM RED ALLCLEAR V12DAC	AUTOMAX	139	32756	LDESEXLBA9S(1X10)V240 AC6	ELECTRA	85
32454	ELYPS LM GREEN ALLCLEAR V12DAC	AUTOMAX	139	32758	LDESEXLBA9S(1X10)V240 AC8	ELECTRA	85
32455	ELYPS LM YELLOW ALLCLEAR V12DAC	AUTOMAX	139	32761	LDESEXL E10(1X10)V6 DCAC1	ELECTRA	85
32457	ELYPS WM LT 4X V12/24DAC GY	AUTOMAX	138	32762	LDESEXL E10(1X10)V6 DCAC2	ELECTRA	85
32458	ELYPS WM LT 4X V12/24DAC BK	AUTOMAX	138	32763	LDESEXL E10(1X10)V6 DCAC3	ELECTRA	85
32461	ELYPS LM BLUE ALLCOLOR V12DAC	AUTOMAX	139	32765	LDESEXL E10(1X10)V6 DCAC5	ELECTRA	85
32462	ELYPS LM AMBER ALLCOLOR V12DAC	AUTOMAX	139	32766	LDESEXL E10(1X10)V6 DCAC6	ELECTRA	85
32463	ELYPS LM RED ALLCOLOR V12DAC	AUTOMAX	139	32768	LDESEXL E10(1X10)V6 DCAC8	ELECTRA	85
32464	ELYPS LM GREEN ALLCOLOR 12VDAC	AUTOMAX	139	32771	LDESEXL E10(1X10)V12 DCAC1	ELECTRA	85
32465	ELYPS LM YELLOW ALLCOLOR 12VDAC	AUTOMAX	139	32772	LDESEXL E10(1X10)V12 DCAC2	ELECTRA	85
32466	ELYPS LM CLEAR 12VDAC	AUTOMAX	139	32773	LDESEXL E10(1X10)V12 DCAC3	ELECTRA	85
32467	ELYPS WM LT MULTI 4X V12/24DAC GY	AUTOMAX	138	32775	LDESEXL E10(1X10)V12 DCAC5	ELECTRA	85
32468	ELYPS WM LT MULTI 4X V12/24DAC BK	AUTOMAX	138	32776	LDESEXL E10(1X10)V12 DCAC6	ELECTRA	85
32471	ELYPS LM BLUE PROXIMITY 12VDAC	AUTOMAX	139	32778	LDESEXL E10(1X10)V12 DCAC8	ELECTRA	85
32472	ELYPS LM AMBER PROXIMITY 12VDAC	AUTOMAX	139	32781	LDESEXL E10(1X10)V24 DCAC1	ELECTRA	85
32473	ELYPS LM RED PROXIMITY 12VDAC	AUTOMAX	139	32782	LDESEXL E10(1X10)V24 DCAC2	ELECTRA	85
32474	ELYPS LM GREEN PROXIMITY 12VDAC	AUTOMAX	139	32783	LDESEXL E10(1X10)V24 DCAC3	ELECTRA	85
32475	ELYPS LM YELLOW PROXIMITY 12VDAC	AUTOMAX	139	32785	LDESEXL E10(1X10)V24 DCAC5	ELECTRA	85
32476	ELYPS LM CLEAR PROXIMITY 12VDAC	AUTOMAX	139	32786	LDESEXL E10(1X10)V24 DCAC6	ELECTRA	85
32701	LDESEXLBA9S(1X10)V6 DCAC1	ELECTRA	85	32788	LDESEXL E10(1X10)V24 DCAC8	ELECTRA	85
32702	LDESEXLBA9S(1X10)V6 DCAC2	ELECTRA	85	32791	LDESEXL E10(1X10)V48 DCAC1	ELECTRA	85
32703	LDESEXLBA9S(1X10)V6 DCAC3	ELECTRA	85	32792	LDESEXL E10(1X10)V48 DCAC2	ELECTRA	85
32705	LDESEXLBA9S(1X10)V6 DCAC5	ELECTRA	85	32793	LDESEXL E10(1X10)V48 DCAC3	ELECTRA	85
32706	LDESEXLBA9S(1X10)V6 DCAC6	ELECTRA	85	32795	LDESEXL E10(1X10)V48 DCAC5	ELECTRA	85
32708	LDESEXLBA9S(1X10)V6 DCAC8	ELECTRA	85	32796	LDESEXL E10(1X10)V48 DCAC6	ELECTRA	85
32711	LDESEXLBA9S(1X10)V12 DCAC1	ELECTRA	85	32798	LDESEXL E10(1X10)V48 DCAC8	ELECTRA	85
32712	LDESEXLBA9S(1X10)V12 DCAC2	ELECTRA	85	32801	LDESEXL E10(1X10)V110 DCAC1	ELECTRA	85
32713	LDESEXLBA9S(1X10)V12 DCAC3	ELECTRA	85	32802	LDESEXL E10(1X10)V110 DCAC2	ELECTRA	85
32715	LDESEXLBA9S(1X10)V12 DCAC5	ELECTRA	85	32803	LDESEXL E10(1X10)V110 DCAC3	ELECTRA	85
32716	LDESEXLBA9S(1X10)V12 DCAC6	ELECTRA	85	32805	LDESEXL E10(1X10)V110 DCAC5	ELECTRA	85
32718	LDESEXLBA9S(1X10)V12 DCAC8	ELECTRA	85	32806	LDESEXL E10(1X10)V110 DCAC6	ELECTRA	85
32721	LDESEXLBA9S(1X10)V24 DCAC1	ELECTRA	85	32808	LDESEXL E10(1X10)V110 DCAC8	ELECTRA	85
32722	LDESEXLBA9S(1X10)V24 DCAC2	ELECTRA	85	32811	LDESEXL E10(1X10)V240 AC1	ELECTRA	85
32723	LDESEXLBA9S(1X10)V24 DCAC3	ELECTRA	85	32812	LDESEXL E10(1X10)V240 AC2	ELECTRA	85
32725	LDESEXLBA9S(1X10)V24 DCAC5	ELECTRA	85	32813	LDESEXL E10(1X10)V240 AC3	ELECTRA	85
32726	LDESEXLBA9S(1X10)V24 DCAC6	ELECTRA	85	32815	LDESEXL E10(1X10)V240 AC5	ELECTRA	85
32728	LDESEXLBA9S(1X10)V24 DCAC8	ELECTRA	85	32816	LDESEXL E10(1X10)V240 AC6	ELECTRA	85
32731	LDESEXLBA9S(1X10)V48 DCAC1	ELECTRA	85	32818	LDESEXL E10(1X10)V240 AC8	ELECTRA	85
32732	LDESEXLBA9S(1X10)V48 DCAC2	ELECTRA	85	33010	BIP 81 V12DAC BK	ELECTRA	76
32733	LDESEXLBA9S(1X10)V48 DCAC3	ELECTRA	85	33011	BIP 81 V24DAC BK	ELECTRA	76
32735	LDESEXLBA9S(1X10)V48 DCAC5	ELECTRA	85	33012	BIP 81 V110AC BK	ELECTRA	76
32736	LDESEXLBA9S(1X10)V48 DCAC6	ELECTRA	85	33014	BIP 81 V240AC BK	ELECTRA	76
32738	LDESEXLBA9S(1X10)V48 DCAC8	ELECTRA	85	33015	BIP 81 V48DAC BK	ELECTRA	76
32741	LDESEXLBA9S(1X10)V110 DCAC1	ELECTRA	85	33040	BIP 81 V110DC BK	ELECTRA	76
32742	LDESEXLBA9S(1X10)V110 DCAC2	ELECTRA	85	33042	BIP 81 V240DC BK	ELECTRA	76
32743	LDESEXLBA9S(1X10)V110 DCAC3	ELECTRA	85	33060	BIP 84 V12DAC BK	ELECTRA	75
32745	LDESEXLBA9S(1X10)V110 DCAC5	ELECTRA	85	33061	BIP 84 V24DAC BK	ELECTRA	75
32746	LDESEXLBA9S(1X10)V110 DCAC6	ELECTRA	85	33063	BIP 84 V110AC BK	ELECTRA	75
32748	LDESEXLBA9S(1X10)V110 DCAC8	ELECTRA	85	33065	BIP 84 V48DAC BK	ELECTRA	75
32751	LDESEXLBA9S(1X10)V240 AC1	ELECTRA	85	33066	BIP 84 V240AC BK	ELECTRA	75
32752	LDESEXLBA9S(1X10)V240 AC2	ELECTRA	85	33067	BIP 84 V110DC BK	ELECTRA	75

Code	Description	Section	Page	Code	Description	Section	Page
33069	BIP 84 V240DC BK	ELECTRA	75	33232	TWS LED A/Y M CL V240AC BK	AUTOMAX	151
33080	BIP 92 V12DAC BK	ELECTRA	73	33233	TWS LED RED M CL V240AC BK	AUTOMAX	151
33081	BIP 92 V24DAC BK	ELECTRA	73	33234	TWS LED GRE M CL V240AC BK	AUTOMAX	151
33082	BIP 92 V48DAC BK	ELECTRA	73	33241	MINITWS BLU S/F CL V24DAC GY	AUTOMAX	161
33083	BIP 92 V110DC BK	ELECTRA	73	33242	MINITWS AMB S/F CL V24DAC GY	AUTOMAX	161
33084	BIP 92 V110AC BK	ELECTRA	73	33243	MINITWS RED S/F CL V24DAC GY	AUTOMAX	161
33087	BIP 92 V240AC BK	ELECTRA	73	33244	MINITWS GRE S/F CL V24DAC GY	AUTOMAX	161
33088	BIP 92 V240DC BK	ELECTRA	73	33245	MINITWS YEL S/F CL V24DAC GY	AUTOMAX	161
33121	TWS LED BLU S CL V24DAC GY	AUTOMAX	151	33251	MINITWS BLU S/F CL V110AC GY	AUTOMAX	161
33122	TWS LED A/Y S CL V24DAC GY	AUTOMAX	151	33252	MINITWS AMB S/F CL V110AC GY	AUTOMAX	161
33123	TWS LED RED S CL V24DAC GY	AUTOMAX	151	33253	MINITWS RED S/F CL V110AC GY	AUTOMAX	161
33124	TWS LED GRE S CL V24DAC GY	AUTOMAX	151	33254	MINITWS GRE S/F CL V110AC GY	AUTOMAX	161
33131	TWS LED BLU S CL V110AC GY	AUTOMAX	151	33255	MINITWS YEL S/F CL V110AC GY	AUTOMAX	161
33132	TWS LED A/Y S CL V110AC GY	AUTOMAX	151	33261	MINITWS BLU S/F CL V240AC GY	AUTOMAX	161
33133	TWS LED RED S CL V110AC GY	AUTOMAX	151	33262	MINITWS AMB S/F CL V240AC GY	AUTOMAX	161
33134	TWS LED GRE S CL V110AC GY	AUTOMAX	151	33263	MINITWS RED S/F CL V240AC GY	AUTOMAX	161
33141	TWS LED BLU S CL V240AC GY	AUTOMAX	151	33264	MINITWS GRE S/F CL V240AC GY	AUTOMAX	161
33142	TWS LED A/Y S CL V240AC GY	AUTOMAX	151	33265	MINITWS YEL S/F CL V240AC GY	AUTOMAX	161
33143	TWS LED RED S CL V240AC GY	AUTOMAX	151	33271	BABYTWS BLU S CL V24DAC	AUTOMAX	163
33144	TWS LED GRE S CL V240AC GY	AUTOMAX	151	33272	BABYTWS AMB S CL V24DAC	AUTOMAX	163
33151	TWS LED BLU S CL V24DAC BK	AUTOMAX	151	33273	BABYTWS RED S CL V24DAC	AUTOMAX	163
33152	TWS LED A/Y S CL V24DAC BK	AUTOMAX	151	33274	BABYTWS GRE S CL V24DAC	AUTOMAX	163
33153	TWS LED RED S CL V24DAC BK	AUTOMAX	151	33275	BABYTWS YEL S CL V24DAC	AUTOMAX	163
33154	TWS LED GRE S CL V24DAC BK	AUTOMAX	151	33301	MINITWS BLU S/F CL V24DAC BK	AUTOMAX	161
33161	TWS LED BLU S CL V110AC BK	AUTOMAX	151	33302	MINITWS AMB S/F CL V24DAC BK	AUTOMAX	161
33162	TWS LED A/Y S CL V110AC BK	AUTOMAX	151	33303	MINITWS RED S/F CL V24DAC BK	AUTOMAX	161
33163	TWS LED RED S CL V110AC BK	AUTOMAX	151	33304	MINITWS GRE S/F CL V24DAC BK	AUTOMAX	161
33164	TWS LED GRE S CL V110AC BK	AUTOMAX	151	33305	MINITWS YEL S/F CL V24DAC BK	AUTOMAX	161
33171	TWS LED BLU S CL V240AC BK	AUTOMAX	151	33311	MINITWS BLU S/F CL V110AC BK	AUTOMAX	161
33172	TWS LED A/Y S CL V240AC BK	AUTOMAX	151	33312	MINITWS AMB S/F CL V110AC BK	AUTOMAX	161
33173	TWS LED RED S CL V240AC BK	AUTOMAX	151	33313	MINITWS RED S/F CL V110AC BK	AUTOMAX	161
33174	TWS LED GRE S CL V240AC BK	AUTOMAX	151	33314	MINITWS GRE S/F CL V110AC BK	AUTOMAX	161
33181	TWS LED BLU M CL V24DAC GY	AUTOMAX	151	33315	MINITWS YEL S/F CL V110AC BK	AUTOMAX	161
33182	TWS LED A/Y M CL V24DAC GY	AUTOMAX	151	33321	MINITWS BLU S/F CL V240AC BK	AUTOMAX	161
33183	TWS LED RED M CL V24DAC GY	AUTOMAX	151	33322	MINITWS AMB S/F CL V240AC BK	AUTOMAX	161
33184	TWS LED GRE M CL V24DAC GY	AUTOMAX	151	33323	MINITWS RED S/F CL V240AC BK	AUTOMAX	161
33191	TWS LED BLU M CL V110AC GY	AUTOMAX	151	33324	MINITWS GRE S/F CL V240AC BK	AUTOMAX	161
33192	TWS LED A/Y M CL V110AC GY	AUTOMAX	151	33325	MINITWS YEL S/F CL V240AC BK	AUTOMAX	161
33193	TWS LED RED M CL V110AC GY	AUTOMAX	151	33357	TWS STAINLESS BRACKET GY	AUTOMAX	165
33194	TWS LED GRE M CL V110AC GY	AUTOMAX	151	33358	TWS STAINLESS BRACKET BK	AUTOMAX	165
33201	TWS LED BLU M CL V240AC GY	AUTOMAX	151	33400	TWS SOUNDER A+ V12/24DAC GY	AUTOMAX	156
33202	TWS LED A/Y M CL V240AC GY	AUTOMAX	151	33401	TWS SOUNDER A+ V110/240AC GY	AUTOMAX	156
33203	TWS LED RED M CL V240AC GY	AUTOMAX	151	33402	TWS SOUNDER A+ V12/24DAC BK	AUTOMAX	156
33204	TWS LED GRE M CL V240AC GY	AUTOMAX	151	33403	TWS SOUNDER A+ V90/240AC BK	AUTOMAX	156
33211	TWS LED BLU M CL V24DAC BK	AUTOMAX	151	33411	TWS S BLU COLOR V12/24DAC GY	AUTOMAX	152
33212	TWS LED A/Y M CL V24DAC BK	AUTOMAX	151	33412	TWS S AMB COLOR V12/24DAC GY	AUTOMAX	152
33213	TWS LED RED M CL V24DAC BK	AUTOMAX	151	33413	TWS S RED COLOR V12/24DAC GY	AUTOMAX	152
33214	TWS LED GRE M CL V24DAC BK	AUTOMAX	151	33414	TWS S GRE COLOR V12/24DAC GY	AUTOMAX	152
33221	TWS LED BLU M CL V110AC BK	AUTOMAX	151	33415	TWS S YEL COLOR V12/24DAC GY	AUTOMAX	152
33222	TWS LED A/Y M CL V110AC BK	AUTOMAX	151	33416	TWS S CLR V12/24DAC GY	AUTOMAX	152
33223	TWS LED RED M CL V110AC BK	AUTOMAX	151	33421	TWS S BLU COLOR V12/24DAC BK	AUTOMAX	152
33224	TWS LED GRE M CL V110AC BK	AUTOMAX	151	33422	TWS S AMB COLOR V12/24DAC BK	AUTOMAX	152
33231	TWS LED BLU M CL V240AC BK	AUTOMAX	151	33423	TWS S RED COLOR V12/24DAC BK	AUTOMAX	152

Code	Description	Section	Page	Code	Description	Section	Page
33424	TWS S GRE COLOR V12/24DAC BK	AUTOMAX	152	33724	CTL900 S/F A GRE V24DAC GY	ELECTRA	39
33425	TWS S YEL COLOR V12/24DAC BK	AUTOMAX	152	33725	CTL900 S/F A YEL V24DAC GY	ELECTRA	39
33426	TWS S CLR V12/24DAC BK	AUTOMAX	152	33761	CTL900 S/F A BLU V240AC GY	ELECTRA	39
33431	TWS S BLU CLEAR V12/24DAC GY	AUTOMAX	152	33762	CTL900 S/F A AMB V240AC GY	ELECTRA	39
33432	TWS S AMB CLEAR V12/24DAC GY	AUTOMAX	152	33763	CTL900 S/F A RED V240AC GY	ELECTRA	39
33433	TWS S RED CLEAR V12/24DAC GY	AUTOMAX	152	33764	CTL900 S/F A GRE V240AC GY	ELECTRA	39
33434	TWS S GRE CLEAR V12/24DAC GY	AUTOMAX	152	33765	CTL900 S/F A YEL V240AC GY	ELECTRA	39
33435	TWS S YEL CLEAR V12/24DAC GY	AUTOMAX	152	33832	CTL600 STY AMB V12/240DAC GY	ELECTRA	38
33441	TWS S BLU CLEAR V12/24DAC BK	AUTOMAX	152	33833	CTL600 STY RED V12/240DAC GY	ELECTRA	38
33442	TWS S AMB CLEAR V12/24DAC BK	AUTOMAX	152	33834	CTL600 STY GRE V12/240DAC GY	ELECTRA	38
33443	TWS S RED CLEAR V12/24DAC BK	AUTOMAX	152	33835	CTL600 STY YEL V12/240DAC GY	ELECTRA	38
33444	TWS S GRE CLEAR V12/24DAC BK	AUTOMAX	152	33841	CTL900 STY BLU V12/240DAC GY	ELECTRA	39
33445	TWS S YEL CLEAR V12/24DAC BK	AUTOMAX	152	33842	CTL900 STY AMB V12/240DAC GY	ELECTRA	39
33447	TWS RGA CLEAR V12/24DAC GY	AUTOMAX	153	33843	CTL900 STY RED V12/240DAC GY	ELECTRA	39
33448	TWS RGA CLEAR V12/24DAC BK	AUTOMAX	153	33844	CTL900 STY GRE V12/240DAC GY	ELECTRA	39
33522	CTL600 S/F AMB V12/48DC GY	ELECTRA	38	33845	CTL900 STY YEL V12/240DAC GY	ELECTRA	39
33523	CTL600 S/F RED V12/48DC GY	ELECTRA	38	35153	FEU LED 2.0 200 V110/240AC RD	FOUR	180
33524	CTL600 S/F GRE V12/48DC GY	ELECTRA	38	35154	FEU LED 2.0 200 V110/240AC GR	FOUR	180
33525	CTL600 S/F YEL V12/48DC GY	ELECTRA	38	35155	FEU LED 2.0 200 V110/240AC YL	FOUR	180
33532	CTL600 S/F AMB V24/240AC GY	ELECTRA	38	35163	FEU LED 2.0 300 V110/240AC RD	FOUR	180
33533	CTL600 S/F RED V24/240AC GY	ELECTRA	38	35164	FEU LED 2.0 300 V110/240AC GR	FOUR	180
33534	CTL600 S/F GRE V24/240AC GY	ELECTRA	38	35165	FEU LED 2.0 300 V110/240AC YL	FOUR	180
33535	CTL600 S/F YEL V24/240AC GY	ELECTRA	38	36450	BABYTWS WIRING BASE GY	AUTOMAX	163
33561	CTL900 S/F BLU V12/48DC GY	ELECTRA	39	36451	BABYTWS BLU S CO V24DAC	AUTOMAX	163
33562	CTL900 S/F AMB V12/48DC GY	ELECTRA	39	36452	BABYTWS AMB S CO V24DAC	AUTOMAX	163
33563	CTL900 S/F RED V12/48DC GY	ELECTRA	39	36453	BABYTWS RED S CO V24DAC	AUTOMAX	163
33564	CTL900 S/F GRE V12/48DC GY	ELECTRA	39	36454	BABYTWS GRE S CO V24DAC	AUTOMAX	163
33565	CTL900 S/F YEL V12/48DC GY	ELECTRA	39	36455	BABYTWS YEL S CO V24DAC	AUTOMAX	163
33571	CTL900 S/F BLU V24/240AC GY	ELECTRA	39	36456	BABYTWS CLR S V24DAC	AUTOMAX	163
33572	CTL900 S/F AMB V24/240AC GY	ELECTRA	39	36461	BABYTWS SOUNDER GY	AUTOMAX	163
33573	CTL900 S/F RED V24/240AC GY	ELECTRA	39	36471	TWS LED BLU S CO V24DAC GY	AUTOMAX	151
33574	CTL900 S/F GRE V24/240AC GY	ELECTRA	39	36472	TWS LED AMB S CO V24DAC GY	AUTOMAX	151
33575	CTL900 S/F YEL V24/240AC GY	ELECTRA	39	36473	TWS LED RED S CO V24DAC GY	AUTOMAX	151
33652	CTL600 S/F A AMB V12DAC GY	ELECTRA	38	36474	TWS LED GRE S CO V24DAC GY	AUTOMAX	151
33653	CTL600 S/F A RED V12DAC GY	ELECTRA	38	36475	TWS LED YEL S CO V24DAC GY	AUTOMAX	151
33654	CTL600 S/F A GRE V12DAC GY	ELECTRA	38	36476	TWS LED CLR S V24DAC GY	AUTOMAX	151
33655	CTL600 S/F A YEL V12DAC GY	ELECTRA	38	36477	LWX R POLE V12/24DC AMB	WORKPLUS	191
33662	CTL600 S/F A AMB V24DAC GY	ELECTRA	38	36478	LWX F POLE V12/24DC AMB	WORKPLUS	191
33663	CTL600 S/F A RED V24DAC GY	ELECTRA	38	36479	LWX R FLEXI V12/24DC AMB	WORKPLUS	191
33664	CTL600 S/F A GRE V24DAC GY	ELECTRA	38	36480	LWX F FLEXI V12/24DC AMB	WORKPLUS	191
33665	CTL600 S/F A YEL V24DAC GY	ELECTRA	38	36481	TWS LED BLU S CO V110AC GY	AUTOMAX	151
33702	CTL600 S/F A AMB V240AC GY	ELECTRA	38	36482	TWS LED AMB S CO V110AC GY	AUTOMAX	151
33703	CTL600 S/F A RED V240AC GY	ELECTRA	38	36483	TWS LED RED S CO V110AC GY	AUTOMAX	151
33704	CTL600 S/F A GRE V240AC GY	ELECTRA	38	36484	TWS LED GRE S CO V110AC GY	AUTOMAX	151
33705	CTL600 S/F A YEL V240AC GY	ELECTRA	38	36485	TWS LED YEL S CO V110AC GY	AUTOMAX	151
33711	CTL900 S/F A BLU V12DAC GY	ELECTRA	39	36486	TWS LED CLR S V110AC GY	AUTOMAX	151
33712	CTL900 S/F A AMB V12DAC GY	ELECTRA	39	36491	TWS LED BLU S CO V240AC GY	AUTOMAX	151
33713	CTL900 S/F A RED V12DAC GY	ELECTRA	39	36492	TWS LED AMB S CO V240AC GY	AUTOMAX	151
33714	CTL900 S/F A GRE V12DAC GY	ELECTRA	39	36493	TWS LED RED S CO V240AC GY	AUTOMAX	151
33715	CTL900 S/F A YEL V12DAC GY	ELECTRA	39	36494	TWS LED GRE S CO V240AC GY	AUTOMAX	151
33721	CTL900 S/F A BLU V24DAC GY	ELECTRA	39	36495	TWS LED YEL S CO V240AC GY	AUTOMAX	151
33722	CTL900 S/F A AMB V24DAC GY	ELECTRA	39	36496	TWS LED CLR S V240AC GY	AUTOMAX	151
33723	CTL900 S/F A RED V24DAC GY	ELECTRA	39	36501	TWS LED BLU M CO V24DAC GY	AUTOMAX	151

Code	Description	Section	Page	Code	Description	Section	Page
36502	TWS LED AMB M CO V24DAC GY	AUTOMAX	151	36731	TWS LED BLU M CO V240AC BK	AUTOMAX	151
36503	TWS LED RED M CO V24DAC GY	AUTOMAX	151	36732	TWS LED AMB M CO V240AC BK	AUTOMAX	151
36504	TWS LED GRE M CO V24DAC GY	AUTOMAX	151	36733	TWS LED RED M CO V240AC BK	AUTOMAX	151
36505	TWS LED YEL M CO V24DAC GY	AUTOMAX	151	36734	TWS LED GRE M CO V240AC BK	AUTOMAX	151
36506	TWS LED CLR M V24DAC GY	AUTOMAX	151	36735	TWS LED YEL M CO V240AC BK	AUTOMAX	151
36511	TWS LED BLU M CO V110AC GY	AUTOMAX	151	36736	TWS LED CLR M CO V240AC BK	AUTOMAX	151
36512	TWS LED AMB M CO V110AC GY	AUTOMAX	151	37801	BABYSAI LED V12DC GY	ELECTRA	28
36513	TWS LED RED M CO V110AC GY	AUTOMAX	151	37802	BABYSAI LED V24DC GY	ELECTRA	28
36514	TWS LED GRE M CO V110AC GY	AUTOMAX	151	37806	BABYSAI LED V24AC GY	ELECTRA	28
36515	TWS LED YEL M CO V110AC GY	AUTOMAX	151	37808	BABYSAI LED V110AC GY	ELECTRA	28
36516	TWS LED CLR M V110AC GY	AUTOMAX	151	37809	BABYSAI LED V240AC GY	ELECTRA	28
36521	TWS LED BLU M CO V240AC GY	AUTOMAX	151	38000	BEBIP V12DAC GY	ELECTRA	74
36522	TWS LED AMB M CO V240AC GY	AUTOMAX	151	38001	BEBIP V24DAC GY	ELECTRA	74
36523	TWS LED RED M CO V240AC GY	AUTOMAX	151	38002	BEBIP V48DAC GY	ELECTRA	74
36524	TWS LED GRE M CO V240AC GY	AUTOMAX	151	38003	BEBIP V110DC GY	ELECTRA	74
36525	TWS LED YEL M CO V240AC GY	AUTOMAX	151	38004	BEBIP V110AC GY	ELECTRA	74
36526	TWS LED CLR M V240AC GY	AUTOMAX	151	38005	BEBIP V240DC GY	ELECTRA	74
36556	LWX R DIN B V12/24DC AMB	WORKPLUS	191	38006	BEBIP V240AC GY	ELECTRA	74
36557	LWX R DIN A V12/24DC AMB	WORKPLUS	191	38030	BIMF LED V12/240DAC GY	ELECTRA	72
36558	LWX R MAGNETIC V12/24DC AMB	WORKPLUS	191	38032	BIMF LED V12/240DAC RD	ELECTRA	72
36559	LWX F DIN B V12/24DC AMB	WORKPLUS	191	38602	MLAMP LED AMB V12/24DAC GY	ELECTRA	36
36660	LWX F DIN A V12/24DC AMB	WORKPLUS	191	38603	MLAMP LED RED V12/24DAC GY	ELECTRA	36
36661	LWX F MAGNETIC V12/24DC AMB	WORKPLUS	191	38604	MLAMP LED GRE V12/24DAC GY	ELECTRA	36
36681	TWS LED BLU S CO V24DAC BK	AUTOMAX	151	38605	MLAMP LED YEL V12/24DAC GY	ELECTRA	36
36682	TWS LED AMB S CO V24DAC BK	AUTOMAX	151	38612	MLAMP LED AMB V48DAC GY	ELECTRA	36
36683	TWS LED RED S CO V24DAC BK	AUTOMAX	151	38613	MLAMP LED RED V48DAC GY	ELECTRA	36
36684	TWS LED GRE S CO V24DAC BK	AUTOMAX	151	38614	MLAMP LED GRE V48DAC GY	ELECTRA	36
36685	TWS LED YEL S CO V24DAC BK	AUTOMAX	151	38615	MLAMP LED YEL V48DAC GY	ELECTRA	36
36686	TWS LED CLR S CO V24DAC BK	AUTOMAX	151	38622	MLAMP LED AMB V90/240AC GY	ELECTRA	36
36691	TWS LED BLU S CO V110AC BK	AUTOMAX	151	38623	MLAMP LED RED V90/240AC GY	ELECTRA	36
36692	TWS LED AMB S CO V110AC BK	AUTOMAX	151	38624	MLAMP LED GRE V90/240AC GY	ELECTRA	36
36693	TWS LED RED S CO V110AC BK	AUTOMAX	151	38625	MLAMP LED YEL V90/240AC GY	ELECTRA	36
36694	TWS LED GRE S CO V110AC BK	AUTOMAX	151	38632	MLAMP LED A AMB V12/24DAC GY	ELECTRA	36
36695	TWS LED YEL S CO V110AC BK	AUTOMAX	151	38633	MLAMP LED A RED V12/24DAC GY	ELECTRA	36
36696	TWS LED CLR S CO V110AC BK	AUTOMAX	151	38634	MLAMP LED A GRE V12/24DAC GY	ELECTRA	36
36701	TWS LED BLU S CO V240AC BK	AUTOMAX	151	38635	MLAMP LED A YEL V12/24DAC GY	ELECTRA	36
36702	TWS LED AMB S CO V240AC BK	AUTOMAX	151	38642	MLAMP LED A AMB V48DAC GY	ELECTRA	36
36703	TWS LED RED S CO V240AC BK	AUTOMAX	151	38643	MLAMP LED A RED V48DAC GY	ELECTRA	36
36704	TWS LED GRE S CO V240AC BK	AUTOMAX	151	38644	MLAMP LED A GRE V48DAC GY	ELECTRA	36
36705	TWS LED YEL S CO V240AC BK	AUTOMAX	151	38645	MLAMP LED A YEL V48DAC GY	ELECTRA	36
36706	TWS LED CLR S CO V240AC BK	AUTOMAX	151	38652	MLAMP LED A AMB V90/240AC GY	ELECTRA	36
36711	TWS LED BLU M CO V24DAC BK	AUTOMAX	151	38653	MLAMP LED A RED V90/240AC GY	ELECTRA	36
36712	TWS LED AMB M CO V24DAC BK	AUTOMAX	151	38654	MLAMP LED A GRE V90/240AC GY	ELECTRA	36
36713	TWS LED RED M CO V24DAC BK	AUTOMAX	151	38655	MLAMP LED A YEL V90/240AC GY	ELECTRA	36
36714	TWS LED GRE M CO V24DAC BK	AUTOMAX	151	38662	CTL600 LED AMB V12/24DAC GY	ELECTRA	38
36715	TWS LED YEL M CO V24DAC BK	AUTOMAX	151	38663	CTL600 LED RED V12/24DAC GY	ELECTRA	38
36716	TWS LED CLR M CO V24DAC BK	AUTOMAX	151	38664	CTL600 LED GRE V12/24DAC GY	ELECTRA	38
36721	TWS LED BLU M CO V110AC BK	AUTOMAX	151	38665	CTL600 LED YEL V12/24DAC GY	ELECTRA	38
36722	TWS LED AMB M CO V110AC BK	AUTOMAX	151	38672	CTL600 LED AMB V90/240AC GY	ELECTRA	38
36723	TWS LED RED M CO V110AC BK	AUTOMAX	151	38673	CTL600 LED RED V90/240AC GY	ELECTRA	38
36724	TWS LED GRE M CO V110AC BK	AUTOMAX	151	38674	CTL600 LED GRE V90/240AC GY	ELECTRA	38
36725	TWS LED YEL M CO V110AC BK	AUTOMAX	151	38675	CTL600 LED YEL V90/240AC GY	ELECTRA	38
36726	TWS LED CLR M CO V110AC BK	AUTOMAX	151	38682	CTL600 LED A AMB V12/24DAC GY	ELECTRA	38

Code	Description	Section	Page	Code	Description	Section	Page
38683	CTL600 LED A RED V12/24DAC GY	ELECTRA	38	38791	OVOLUX LED BLU R V90/240AC GY	ELECTRA	43
38684	CTL600 LED A GRE V12/24DAC GY	ELECTRA	38	38792	OVOLUX LED AMB R V90/240AC GY	ELECTRA	43
38685	CTL600 LED A YEL V12/24DAC GY	ELECTRA	38	38793	OVOLUX LED RED R V90/240AC GY	ELECTRA	43
38692	CTL600 LED A AMB V90/240AC GY	ELECTRA	38	38794	OVOLUX LED GRE R V90/240AC GY	ELECTRA	43
38693	CTL600 LED A RED V90/240AC GY	ELECTRA	38	38795	OVOLUX LED YEL R V90/240AC GY	ELECTRA	43
38694	CTL600 LED A GRE V90/240AC GY	ELECTRA	38	38796	OVOLUX LED CLR R V90/240AC GY	ELECTRA	43
38695	CTL600 LED A YEL V90/240AC GY	ELECTRA	38	38801	OVOLUX LED BLU M V12/24DAC GY	ELECTRA	43
38701	CTL900 LED BLU V12/24DAC GY	ELECTRA	39	38802	OVOLUX LED AMB M V12/24DAC GY	ELECTRA	43
38702	CTL900 LED AMB V12/24DAC GY	ELECTRA	39	38803	OVOLUX LED RED M V12/24DAC GY	ELECTRA	43
38703	CTL900 LED RED V12/24DAC GY	ELECTRA	39	38804	OVOLUX LED GRE M V12/24DAC GY	ELECTRA	43
38704	CTL900 LED GRE V12/24DAC GY	ELECTRA	39	38805	OVOLUX LED YEL M V12/24DAC GY	ELECTRA	43
38705	CTL900 LED YEL V12/24DAC GY	ELECTRA	39	38806	OVOLUX LED CLR M V12/24DAC GY	ELECTRA	43
38711	CTL900 LED BLU V90/240AC GY	ELECTRA	39	38811	OVOLUX LED BLU M V90/240AC GY	ELECTRA	43
38712	CTL900 LED AMB V90/240AC GY	ELECTRA	39	38812	OVOLUX LED AMB M V90/240AC GY	ELECTRA	43
38713	CTL900 LED RED V90/240AC GY	ELECTRA	39	38813	OVOLUX LED RED M V90/240AC GY	ELECTRA	43
38714	CTL900 LED GRE V90/240AC GY	ELECTRA	39	38814	OVOLUX LED GRE M V90/240AC GY	ELECTRA	43
38715	CTL900 LED YEL V90/240AC GY	ELECTRA	39	38815	OVOLUX LED YEL M V90/240AC GY	ELECTRA	43
38721	CTL900 LED A BLU V12/24DAC GY	ELECTRA	39	38816	OVOLUX LED CLR M V90/240AC GY	ELECTRA	43
38722	CTL900 LED A AMB V12/24DAC GY	ELECTRA	39	38822	SEM LED AMB V12DC GY	ELECTRA	32
38723	CTL900 LED A RED V12/24DAC GY	ELECTRA	39	38823	SEM LED RED V12DC GY	ELECTRA	32
38724	CTL900 LED A GRE V12/24DAC GY	ELECTRA	39	38832	SEM LED AMB V12AC GY	ELECTRA	32
38725	CTL900 LED A YEL V12/24DAC GY	ELECTRA	39	38833	SEM LED RED V12AC GY	ELECTRA	32
38731	CTL900 LED A BLU V90/240AC GY	ELECTRA	39	38842	SEM LED AMB V24DC GY	ELECTRA	32
38732	CTL900 LED A AMB V90/240AC GY	ELECTRA	39	38843	SEM LED RED V24DC GY	ELECTRA	32
38733	CTL900 LED A RED V90/240AC GY	ELECTRA	39	38852	SEM LED AMB V24AC GY	ELECTRA	32
38734	CTL900 LED A GRE V90/240AC GY	ELECTRA	39	38853	SEM LED RED V24AC GY	ELECTRA	32
38735	CTL900 LED A YEL V90/240AC GY	ELECTRA	39	38862	SEM LED AMB V110AC GY	ELECTRA	32
38741	CTL1200 LED BLU V12/24DAC GY	ELECTRA	40	38863	SEM LED RED V110AC GY	ELECTRA	32
38742	CTL1200 LED AMB V12/24DAC GY	ELECTRA	40	38872	SEM LED AMB V240AC GY	ELECTRA	32
38743	CTL1200 LED RED V12/24DAC GY	ELECTRA	40	38873	SEM LED RED V240AC GY	ELECTRA	32
38744	CTL1200 LED GRE V12/24DAC GY	ELECTRA	40	40301	SEM V6/8AC GY	ELECTRA	31
38745	CTL1200 LED YEL V12/24DAC GY	ELECTRA	40	40302	SEM V12DC GY	ELECTRA	31
38751	CTL1200 LED BLU V90/240AC GY	ELECTRA	40	40303	SEM V12AC GY	ELECTRA	31
38752	CTL1200 LED AMB V90/240AC GY	ELECTRA	40	40304	SEM V24DC GY	ELECTRA	31
38753	CTL1200 LED RED V90/240AC GY	ELECTRA	40	40305	SEM V24AC GY	ELECTRA	31
38754	CTL1200 LED GRE V90/240AC GY	ELECTRA	40	40307	SEM V48AC GY	ELECTRA	31
38755	CTL1200 LED YEL V90/240AC GY	ELECTRA	40	40308	SEM V110DC GY	ELECTRA	31
38761	CTL1200 LED A BLU V12/24DAC GY	ELECTRA	40	40309	SEM V110AC GY	ELECTRA	31
38762	CTL1200 LED A AMB V12/24DAC GY	ELECTRA	40	40310	SEM V240DC GY	ELECTRA	31
38763	CTL1200 LED A RED V12/24DAC GY	ELECTRA	40	40311	SEM V240AC GY	ELECTRA	31
38764	CTL1200 LED A GRE V12/24DAC GY	ELECTRA	40	40312	SEM PLUS V12/24DC GY	ELECTRA	31
38765	CTL1200 LED A YEL V12/24DAC GY	ELECTRA	40	40931	LD 4.5.4 WO BA15DV12 DCAC1	ELECTRA/AUTOMAX	86/164
38771	CTL1200 LED A BLU V90/240AC GY	ELECTRA	40	40932	LD 4.5.4 WO BA15DV12 DCAC2	ELECTRA/AUTOMAX	86/164
38772	CTL1200 LED A AMB V90/240AC GY	ELECTRA	40	40933	LD 4.5.4 WO BA15DV12 DCAC3	ELECTRA/AUTOMAX	86/164
38773	CTL1200 LED A RED V90/240AC GY	ELECTRA	40	40934	LD 4.5.4 WO BA15DV12 DCAC4	ELECTRA/AUTOMAX	86/164
38774	CTL1200 LED A GRE V90/240AC GY	ELECTRA	40	40935	LD 4.5.4 WO BA15DV12 DCAC5	ELECTRA/AUTOMAX	86/164
38775	CTL1200 LED A YEL V90/240AC GY	ELECTRA	40	40936	LD 4.5.4 WO BA15DV12 DCAC6	ELECTRA/AUTOMAX	86/164
38781	OVOLUX LED BLU R V12/24DAC GY	ELECTRA	43	40941	LD 4.5.4 WO BA15DV24 DCAC1	ELECTRA/AUTOMAX	86/164
38782	OVOLUX LED AMB R V12/24DAC GY	ELECTRA	43	40942	LD 4.5.4 WO BA15DV24 DCAC2	ELECTRA/AUTOMAX	86/164
38783	OVOLUX LED RED R V12/24DAC GY	ELECTRA	43	40943	LD 4.5.4 WO BA15DV24 DCAC3	ELECTRA/AUTOMAX	86/164
38784	OVOLUX LED GRE R V12/24DAC GY	ELECTRA	43	40944	LD 4.5.4 WO BA15DV24 DCAC4	ELECTRA/AUTOMAX	86/164
38785	OVOLUX LED YEL R V12/24DAC GY	ELECTRA	43	40945	LD 4.5.4 WO BA15DV24 DCAC5	ELECTRA/AUTOMAX	86/164
38786	OVOLUX LED CLR R V12/24DAC GY	ELECTRA	43	40946	LD 4.5.4 WO BA15DV24 DCAC6	ELECTRA/AUTOMAX	86/164

Code	Description	Section	Page	Code	Description	Section	Page
40951	LD 4.5.4 WO BA15DV110 AC1	ELECTRA/AUTOMAX	86/164	42210	MICRO W10 S AT V110AC GY	ELECTRA	17
40952	LD 4.5.4 WO BA15DV110 AC2	ELECTRA/AUTOMAX	86/164	42212	MICRO W10 S AT V240AC GY	ELECTRA	17
40953	LD 4.5.4 WO BA15DV110 AC3	ELECTRA/AUTOMAX	86/164	42250	SAI C V12DC GY	ELECTRA	30
40954	LD 4.5.4 WO BA15DV110 AC4	ELECTRA/AUTOMAX	86/164	42252	SAI C V24DC GY	ELECTRA	30
40955	LD 4.5.4 WO BA15DV110 AC5	ELECTRA/AUTOMAX	86/164	42253	SAI C V24AC GY	ELECTRA	30
40956	LD 4.5.4 WO BA15DV110 AC6	ELECTRA/AUTOMAX	86/164	42254	SAI C V48DC GY	ELECTRA	30
40961	LD 4.5.4 WO BA15DV240 AC1	ELECTRA/AUTOMAX	86/164	42255	SAI C V48AC GY	ELECTRA	30
40962	LD 4.5.4 WO BA15DV240 AC2	ELECTRA/AUTOMAX	86/164	42257	SAI C V110AC GY	ELECTRA	30
40963	LD 4.5.4 WO BA15DV240 AC3	ELECTRA/AUTOMAX	86/164	42259	SAI C V240AC GY	ELECTRA	30
40964	LD 4.5.4 WO BA15DV240 AC4	ELECTRA/AUTOMAX	86/164	42300	BIP 81 V12DAC GY	ELECTRA	76
40965	LD 4.5.4 WO BA15DV240 AC5	ELECTRA/AUTOMAX	86/164	42301	BIP 81 V24DAC GY	ELECTRA	76
40966	LD 4.5.4 WO BA15DV240 AC6	ELECTRA/AUTOMAX	86/164	42302	BIP 81 V48DAC GY	ELECTRA	76
41541	BOX CONNESSIONE	ESCAPE	265	42303	BIP 81 V110DC GY	ELECTRA	76
41543	BOX INTERFACCIA	ESCAPE	265	42304	BIP 81 V110AC GY	ELECTRA	76
41544	INTERFACCIA ETHERNET	ESCAPE	265	42307	BIP 81 V240DC GY	ELECTRA	76
41550	SCHEDA COM CENTRALE	ESCAPE	265	42308	BIP 81 V240AC GY	ELECTRA	76
42000	MINICELERE V12DAC GY	ELECTRA	14	42318	BIP 92 V12DAC GY	ELECTRA	73
42001	MINICELERE V24DAC GY	ELECTRA	14	42319	BIP 92 V24DAC GY	ELECTRA	73
42002	MINICELERE V48DAC GY	ELECTRA	14	42320	BIP 92 V48DAC GY	ELECTRA	73
42003	MINICELERE V110DAC GY	ELECTRA	14	42321	BIP 92 V110DC GY	ELECTRA	73
42005	MINICELERE V240DAC GY	ELECTRA	14	42322	BIP 92 V110AC GY	ELECTRA	73
42006	MINICELERE BA V12DC GY	ELECTRA	14	42325	BIP 92 V240DC GY	ELECTRA	73
42007	MINICELERE BA V24DC GY	ELECTRA	14	42326	BIP 92 V240AC GY	ELECTRA	73
42021	CELERE V24DAC GY	ELECTRA	14	42345	BIP 84 V12DAC GY	ELECTRA	75
42022	CELERE V48DAC GY	ELECTRA	14	42346	BIP 84 V24DAC GY	ELECTRA	75
42023	CELERE V110DAC GY	ELECTRA	14	42347	BIP 84 V48DAC GY	ELECTRA	75
42025	CELERE V240DAC GY	ELECTRA	14	42348	BIP 84 V110DC GY	ELECTRA	75
42026	CELERE BA V12DC GY	ELECTRA	14	42349	BIP 84 V110AC GY	ELECTRA	75
42027	CELERE BA V24DC GY	ELECTRA	14	42352	BIP 84 V240DC GY	ELECTRA	75
42042	SUPERCELERE V48DAC GY	ELECTRA	14	42353	BIP 84 V240AC GY	ELECTRA	75
42043	SUPERCELERE V110DAC GY	ELECTRA	14	42363	SAI I V24AC GY	ELECTRA	30
42045	SUPERCELERE V240DAC GY	ELECTRA	14	42365	SAI I V48AC GY	ELECTRA	30
42046	SUPERCELERE BA V12DC GY	ELECTRA	14	42366	SAI I V110AC GY	ELECTRA	30
42047	SUPERCELERE BA V24DC GY	ELECTRA	14	42368	SAI I V240AC GY	ELECTRA	30
42060	MINICELEREST V12DAC GY	ELECTRA	15	43002	MXF LED FLR AMB S V12/24DAC GY	ELECTRA	58
42061	MINICELEREST V24DAC GY	ELECTRA	15	43003	MXF LED FLR RED S V12/24DAC GY	ELECTRA	58
42063	MINICELEREST V110DAC GY	ELECTRA	15	43004	MXF LED FLR GRE S V12/24DAC GY	ELECTRA	58
42065	MINICELEREST V240DAC GY	ELECTRA	15	43005	MXF LED FLR YEL S V12/24DAC GY	ELECTRA	58
42066	MINICELEREST BA V12DC GY	ELECTRA	15	43012	MXF LED FLR AMB S V90/240AC GY	ELECTRA	58
42067	MINICELEREST BA V24DC GY	ELECTRA	15	43013	MXF LED FLR RED S V90/240AC GY	ELECTRA	58
42083	CELEREST V110DAC GY	ELECTRA	15	43014	MXF LED FLR GRE S V90/240AC GY	ELECTRA	58
42085	CELEREST V240DAC GY	ELECTRA	15	43015	MXF LED FLR YEL S V90/240AC GY	ELECTRA	58
42086	CELEREST BA V12DC GY	ELECTRA	15	43042	MXF LED SLR AMB S V12/24DAC GY	ELECTRA	58
42087	CELEREST BA V24DC GY	ELECTRA	15	43043	MXF LED SLR RED S V12/24DAC GY	ELECTRA	58
42103	SUPERCELEREST V110DAC GY	ELECTRA	15	43044	MXF LED SLR GRE S V12/24DAC GY	ELECTRA	58
42105	SUPERCELEREST V240DAC GY	ELECTRA	15	43045	MXF LED SLR YEL S V12/24DAC GY	ELECTRA	58
42106	SUPERCELEREST BA V12DC GY	ELECTRA	15	43052	MXF LED SLR AMB S V90/240AC GY	ELECTRA	58
42107	SUPERCELEREST BA V24DC GY	ELECTRA	15	43053	MXF LED SLR RED S V90/240AC GY	ELECTRA	58
42200	MICRO W10 S V12DC GY	ELECTRA	17	43054	MXF LED SLR GRE S V90/240AC GY	ELECTRA	58
42202	MICRO W10 S V24DC GY	ELECTRA	17	43055	MXF LED SLR YEL S V90/240AC GY	ELECTRA	58
42203	MICRO W10 S V24AC GY	ELECTRA	17	44000	LED WORK LAMP 18W 6LED V10/30DC BK	WORKPLUS	196
42208	MICRO W10 R V12DC GY	ELECTRA	17	44001	LED WORK LAMP 15W 5LED V10/30DC BK	WORKPLUS	194
42209	MICRO W10 R V24DC GY	ELECTRA	17	44004	LED REV LAMP 18W 6LED V10/30DC BK	WORKPLUS	201

Code	Description	Section	Page	Code	Description	Section	Page
44005	LED WORK LAMP 15W 9LED V10/30DC BK	WORKPLUS	195	50529	OBSTAFLASH LED 180 TYPE C 48VDC R	ICARO	314
44006	LED WORK LAMP 21W 14LED V10/30DC BK	WORKPLUS	197	50530	OBSTAFLASH LED 180 TYPE A 48VDC W	ICARO	314
50349	CELERSON 1PHASE V240AC	ELECTRA	16	50531	OBSTAFLASH LED 180 TYPE B+A 48VDC RW	ICARO	314
50351	CELERSON 3PHASE V380AC	ELECTRA	16	50532	OBSTAFLASH LED 180 TYPE C+A 48VDC RW	ICARO	314
50401	SE 12/41 MS5 V12/24DAC GY	ELECTRA	22	50533	POWER CABINET 4X180 230VAC	ICARO	314
50403	SE 12/41 MS5 V110AC GY	ELECTRA	22	50534	KIT OBSTAFLASH LED 4X180 TYPE BC+A 48VDC RW	ICARO	314
50404	SE 12/41 MS5 V240AC GY	ELECTRA	22	50535	KIT OBSTAFLASH LED 4X180 TYPE BC+A 230VAC RW	ICARO	314
50410	SE 25/50 MS5 V12/24DAC GY	ELECTRA	24	50536	OBSTAFLASH POWER CARD	ICARO	318
50412	SE 25/50 MS5 V110AC GY	ELECTRA	24	50537	OBSTAFLASH 120 864+865/BC+A 48VDC RW	ICARO	310/312
50413	SE 25/50 MS5 V240AC GY	ELECTRA	24	50538	SYNCHRO GPS 24-48VDC	ICARO	321
50414	SE 4/25 L PLC V24DC GY	ELECTRA	20	50539	DIAGNOSTIC 3G/GPRS	ICARO	322
50415	SE 4/29 MS5 V12/24DAC GY	ELECTRA	20	50540	OBSTAFLASH LED HI TYPE A 110/240VAC W	ICARO	316
50417	SE 4/29 MS5 V110AC GY	ELECTRA	20	50541	HIGH INTENSITY PHOTOCELL 48VDC	ICARO	320
50418	SE 4/29 MS5 V240AC GY	ELECTRA	20	50542	PHOTOCELL 230VAC	ICARO	320
50419	SE 10/32 MS5 V12/24DAC GY	ELECTRA	21	50543	PHOTOCELL 120VAC	ICARO	320
50421	SE 10/32 MS5 V110AC GY	ELECTRA	21	50544	PHOTOCELL 48VDC	ICARO	320
50422	SE 10/32 MS5 V240AC GY	ELECTRA	21	50545	PHOTOCELL 24VDC	ICARO	320
50423	SE 10/32 MS5 PLC V24DC GY	ELECTRA	21	50546	BATTERY CABINET 1 NAVILITE 48V 2,1AH	ICARO	319
50424	SE 12/35 MS32 V12/24DAC GY	ELECTRA	23	50547	BATTERY CABINET 2/3 NAVILITE 48V 4,5AH	ICARO	319
50426	SE 12/36 MS32 V110AC GY	ELECTRA	23	50548	BATTERY CABINET 4 NAVILITE 48V 7AH	ICARO	319
50427	SE 12/36 MS32 V240AC GY	ELECTRA	23	50549	BATTERY CABINET 8 NAVILITE 48V 12AH O 10BST	ICARO	319
50428	SE PZ/35 MS32 V12/24DAC GY	ELECTRA	23	50550	BATTERY CABINET 16 NAVILITE 48V 24AH O 10BS	ICARO	319
50430	SE PZ/36 MS32 V110AC GY	ELECTRA	23	50551	BATTERY CABINET 7AH 1300W IP65	ICARO	319
50431	SE PZ/36 MS32 V240AC GY	ELECTRA	23	50901	SEP LED MS32 V24DAC GY	ELECTRA	25
50500	NAVILITE TYPE B 48VDC R	ICARO	304	50903	SEP LED MS32 V110AC GY	ELECTRA	25
50501	NAVILITE TYPE B 24VDC R	ICARO	304	50904	SEP LED MS32 V240AC GY	ELECTRA	25
50502	SOLAR NAVILITE TYPE A 12VDC R	ICARO	306	50911	SEP LED MS32 PZ V24DAC GY	ELECTRA	25
50503	KIT NAVILITE D/N TYPE B 230VAC R	ICARO	305	50913	SEP LED MS32 PZ V110AC GY	ELECTRA	25
50504	NAVILITE FAA L-810 110/240VAC R	ICARO	307	50914	SEP LED MS32 PZ V240AC GY	ELECTRA	25
50505	NAVILITE FIXING BRACKET	ICARO	318	51011	AWL 810/HEL PSU V110/240ACDC	ICARO	324
50506	NAVILITE D/N COMMAND BOX 48VDC	ICARO	318	51012	AWL HELIX V12/30DC G	ICARO	324
50507	NAVILITE D/N COMMAND BOX 230VAC	ICARO	318	51013	AWL 810/HELIX SIDE BRACKET	ICARO	324
50508	OBSTAFLASH LED 865/A 48VDC W	ICARO	308	51038	AWL 810/C ISO B AMBER	ICARO	326
50509	OBSTAFLASH LED 864/C 48VDC R	ICARO	308	51039	AWL 810/C ISO A AMBER	ICARO	326
50510	OBSTAFLASH LED 864/B 48VDC R	ICARO	308	51040	AWL 810/C MAGNETIC BASE AMB	ICARO	326
50511	OBSTAFLASH LED 864+865/B+A 48VDC RW	ICARO	308	51041	AWL 810/C ISO B BLUE	ICARO	326
50512	OBSTAFLASH LED 864+865/C+A 48VDC RW	ICARO	308	51042	AWL 810/C ISO A BLUE	ICARO	326
50513	OBSTAFLASH LED 865/A 110/240VAC W	ICARO	308	51043	AWL 810/C MAGNETIC BASE BLU	ICARO	326
50514	OBSTAFLASH LED 864/B 110/240VAC R	ICARO	308	52341	REVERSER V10/100DC BK	WORKPLUS	202
50515	OBSTAFLASH LED 864/C 110/240VAC R	ICARO	308	53002	MICROSAI C V12AC GY	ELECTRA	29
50516	OBSTAFLASH LED 864+865/B+A 110/240VAC RW	ICARO	308	53003	MICROSAI C V24AC GY	ELECTRA	29
50517	OBSTAFLASH LED 864+865/C+A 110/240VAC RW	ICARO	308	53005	MICROSAI C V48AC GY	ELECTRA	29
50518	KIT OBSTAFLASH 3X120 864/B 48VDC R	ICARO	310	53008	MICROSAI C V110AC GY	ELECTRA	29
50519	KIT OBSTAFLASH 3X120 864/C 48VDC R	ICARO	310	53015	MICROSAI C V240AC GY	ELECTRA	29
50520	KIT OBSTAFLASH 3X120 865/A 48VDC W	ICARO	310	53530	MICROSAI I V12AC GY	ELECTRA	29
50521	KIT OBSTAFLASH 3X120 864+865/B+A 48VDC RW	ICARO	310	53531	MICROSAI I V24AC GY	ELECTRA	29
50522	KIT OBSTAFLASH 3X120 864+865/C+A 48VDC RW	ICARO	310	53532	MICROSAI I V48AC GY	ELECTRA	29
50523	KIT OBSTAFLASH 3X120 864/C 110/240VAC R	ICARO	312	53533	MICROSAI I V110AC GY	ELECTRA	29
50524	KIT OBSTAFLASH 3X120 864/B 110/240VAC R	ICARO	312	53535	MICROSAI I V240AC GY	ELECTRA	29
50525	KIT OBSTAFLASH 3X120 865/A 110/240VAC W	ICARO	312	54200	SIAD 165 RED V12AC	ELECTRA	33
50526	KIT OBSTAFLASH 3X120 864+865/B+A 110/240V	ICARO	312	54201	SIAD 165 RED V24AC	ELECTRA	33
50527	KIT OBSTAFLASH 3X120 864+865/C+A 110/240V	ICARO	312	54204	SIAD 165 RED V110AC	ELECTRA	33
50528	OBSTAFLASH LED 180 TYPE B 48VDC R	ICARO	314	54206	SIAD 165 RED V240AC	ELECTRA	33

Code	Description	Section	Page	Code	Description	Section	Page
54207	SIAD 165 GRAY V12AC	ELECTRA	33	57997	ETH 12 MD V110AC	EXPRO	219
54208	SIAD 165 GRAY V24AC	ELECTRA	33	57998	ETH 20 MD V12/24DAC	EXPRO / ESCAPE	319/278
54211	SIAD 165 GRAY V110AC	ELECTRA	33	62242	EX 065 SCT V110DAC	EXPRO	218
54213	SIAD 165 GRAY V240AC	ELECTRA	33	62243	EX 065 SCL V240DAC	EXPRO	218
54214	SIAD 165 RED V12DC	ELECTRA	33	62245	EX 065 SCL V48DAC	EXPRO	218
54215	SIAD 165 RED V24DC	ELECTRA	33	62246	EX 065 SCL V110DAC	EXPRO	218
54218	SIAD 165 RED V110DC	ELECTRA	33	62247	EX 065 SCL V240DAC	EXPRO	218
54220	SIAD 165 RED V240DC	ELECTRA	33	62248	EX 055 MCT V12DAC	EXPRO	217
54221	SIAD 165 GRAY V12DC	ELECTRA	33	62249	EX 055 MCT V24DAC	EXPRO	217
54222	SIAD 165 GRAY V24DC	ELECTRA	33	62251	EX 055 MCT V110DAC	EXPRO	217
54225	SIAD 165 GRAY V110DC	ELECTRA	33	62252	EX 055 MCT V240DAC	EXPRO	217
54227	SIAD 165 GRAY V240DC	ELECTRA	33	62253	EX 055 MCL V12DAC	EXPRO	217
54234	SIAD 215 RED V240AC	ELECTRA	33	62254	EX 055 MCL V24DAC	EXPRO	217
54241	SIAD 215 GRAY V240AC	ELECTRA	33	62255	EX 055 MCL V48DAC	EXPRO	217
54243	SIAD 215 RED V24DC	ELECTRA	33	62256	EX 055 MCL V110DAC	EXPRO	217
54250	SIAD 215 GRAY V24DC	ELECTRA	33	62257	EX 055 MCL V240DAC	EXPRO	217
55300	SEO 2 SEV 4S AA V230AC RD	ESCAPE	258	62258	EX 165 SIAD V12AC	EXPRO	216
55303	SEO 1 SEV 4S AA V230AC RD	ESCAPE	256	62259	EX 165 SIAD V24AC	EXPRO	216
55305	SEL 1 SEV 4S AA V230AC GY	ESCAPE	254	62261	EX 165 SIAD V110AC	EXPRO	216
55307	F3 SEV 4S AA V230AC GY	ESCAPE	252	62262	EX 165 SIAD V240AC	EXPRO	216
55308	F3 SEV 4S AA V230AC RD	ESCAPE	252	62267	EX 215 SIAD V240AC	EXPRO	216
55309	BOX SEO 1 ETH 20 MD/4U AA	ESCAPE	278	62273	EX 165 SIADEL V12DC	EXPRO	216
55310	BOX SEO 1 ETH 20 MD/4U AA PCS	ESCAPE	278	62274	EX 165 SIADEL V24DC	EXPRO	216
55312	STR 1 SEV 4S AA V240AC AMB	ESCAPE	260	62276	EX 165 SIADEL V110DC	EXPRO	216
55313	STR 1 SEV 4S AA V240AC RED	ESCAPE	260	62277	EX 165 SIADEL V240DC	EXPRO	216
55316	STR 1 SEV 4S AA V240AC CLR	ESCAPE	260	62279	EX 215 SIADEL V24DC	EXPRO	216
55319	PULSANTE INCENDIO PCS	ESCAPE	262	63001	ROTALLARM S BLU V12DAC GY	ELECTRA	51
55320	PULSANTE ALLERTAMENTO	ESCAPE	262	63002	ROTALLARM S AMB V12DAC GY	ELECTRA	51
55321	PULSANTE EVACUAZIONE	ESCAPE	262	63003	ROTALLARM S RED V12DAC GY	ELECTRA	51
55323	PULSANTE INCENDIO	ESCAPE	262	63004	ROTALLARM S GRE V12DAC GY	ELECTRA	51
55325	CARTELLO ALLERTAMENTO	ESCAPE	262	63005	ROTALLARM S YEL V12DAC GY	ELECTRA	51
55326	CARTELLO EVACUAZIONE	ESCAPE	262	63013	ROTALLARM S BLU V24DAC GY	ELECTRA	51
55327	CARTELLO INCENDIO	ESCAPE	262	63014	ROTALLARM S AMB V24DAC GY	ELECTRA	51
55328	CARTELLO PUNTO DI RITROVO	ESCAPE	260	63015	ROTALLARM S RED V24DAC GY	ELECTRA	51
55330	SEO 2 SEV 4S AA PCS V230AC RD	ESCAPE	258	63016	ROTALLARM S GRE V24DAC GY	ELECTRA	51
55333	SEO 1 SEV 4S AA PCS V230AC RD	ESCAPE	256	63017	ROTALLARM S YEL V24DAC GY	ELECTRA	51
55335	SEL 1 SEV 4S AA PCS V230AC GY	ESCAPE	254	63037	ROTALLARM S BLU V110AC GY	ELECTRA	51
55337	F3 SEV 4S AA PCS V230AC GY	ESCAPE	252	63038	ROTALLARM S AMB V110AC GY	ELECTRA	51
55338	F3 SEV 4S AA PCS V230AC RD	ESCAPE	252	63039	ROTALLARM S RED V110AC GY	ELECTRA	51
55342	STR 1 SEV 4S AA PCS V240AC AMB	ESCAPE	260	63040	ROTALLARM S GRE V110AC GY	ELECTRA	51
55343	STR 1 SEV 4S AA PCS V240AC RED	ESCAPE	260	63041	ROTALLARM S YEL V110AC GY	ELECTRA	51
55346	STR 1 SEV 4S AA PCS V240AC CLR	ESCAPE	260	63049	ROTALLARM S BLU V240AC GY	ELECTRA	51
55351	CENTRALE SEV SY1 AA PCS	ESCAPE	264	63050	ROTALLARM S AMB V240AC GY	ELECTRA	51
55352	CENTRALE SEV SY2 AA PCS	ESCAPE	264	63051	ROTALLARM S RED V240AC GY	ELECTRA	51
55361	PULSANTE EVACUAZIONE PCS	ESCAPE	262	63052	ROTALLARM S GRE V240AC GY	ELECTRA	51
55362	PULSANTE ALLERTAMENTO PCS	ESCAPE	262	63053	ROTALLARM S YEL V240AC GY	ELECTRA	51
55365	BOX BCP PCS	ESCAPE	263	63055	ROTALLARM S BLU V12DAC H1 GY	ELECTRA	51
55366	BOX BCP PCS LS	ESCAPE	263	63056	ROTALLARM S AMB V12DAC H1 GY	ELECTRA	51
55370	DR SEV SY PCS	ESCAPE	265	63057	ROTALLARM S RED V12DAC H1 GY	ELECTRA	51
55371	DR SEV SY AA PCS	ESCAPE	265	63058	ROTALLARM S GRE V12DAC H1 GY	ELECTRA	51
57994	ETH 12 MD V12/24DAC	EXPRO	219	63059	ROTALLARM S YEL V12DAC H1 GY	ELECTRA	51
57995	ETH 20 MD V240AC	EXPRO	219	63066	ROTALLARM S BLU V24DAC H1 GY	ELECTRA	51
57996	ETH 12 MD V240AC	EXPRO	219	63067	ROTALLARM S AMB V24DAC H1 GY	ELECTRA	51

Code	Description	Section	Page	Code	Description	Section	Page
63068	ROTALLARM S RED V24DAC H1 GY	ELECTRA	51	63831	MNF X YEL E V240AC GY	ELECTRA	56
63069	ROTALLARM S GRE V24DAC H1 GY	ELECTRA	51	63832	MNF X CLR E V240AC GY	ELECTRA	56
63070	ROTALLARM S YEL V24DAC H1 GY	ELECTRA	51	63866	MXF X AMB S V12/24DAC GY	ELECTRA	59
63750	MNF X GRE P V12/24DAC GY	ELECTRA	56	63867	MXF X RED S V12/24DAC GY	ELECTRA	59
63753	MNF X BLU S V12/24DAC GY	ELECTRA	56	63868	MXF X GRE S V12/24DAC GY	ELECTRA	59
63754	MNF X AMB S V12/24DAC GY	ELECTRA	56	63869	MXF X YEL S V12/24DAC GY	ELECTRA	59
63755	MNF X RED S V12/24DAC GY	ELECTRA	56	63872	MXF X AMB S V110AC GY	ELECTRA	59
63756	MNF X GRE S V12/24DAC GY	ELECTRA	56	63873	MXF X RED S V110AC GY	ELECTRA	59
63757	MNF X YEL S V12/24DAC GY	ELECTRA	56	63874	MXF X GRE S V110AC GY	ELECTRA	59
63758	MNF X CLR S V12/24DAC GY	ELECTRA	56	63875	MXF X YEL S V110AC GY	ELECTRA	59
63759	MNF X BLU S V110AC GY	ELECTRA	56	63878	MXF X AMB S V240AC GY	ELECTRA	59
63760	MNF X AMB S V110AC GY	ELECTRA	56	63879	MXF X RED S V240AC GY	ELECTRA	59
63761	MNF X RED S V110AC GY	ELECTRA	56	63880	MXF X GRE S V240AC GY	ELECTRA	59
63762	MNF X GRE S V110AC GY	ELECTRA	56	63881	MXF X YEL S V240AC GY	ELECTRA	59
63763	MNF X YEL S V110AC GY	ELECTRA	56	64113	MLAMP X AMB V12/24DAC GY	ELECTRA	36
63764	MNF X CLR S V110AC GY	ELECTRA	56	64114	MLAMP X RED V12/24DAC GY	ELECTRA	36
63765	MNF X BLU S V240AC GY	ELECTRA	56	64115	MLAMP X GRE V12/24DAC GY	ELECTRA	36
63766	MNF X AMB S V240AC GY	ELECTRA	56	64116	MLAMP X YEL V12/24DAC GY	ELECTRA	36
63767	MNF X RED S V240AC GY	ELECTRA	56	64119	MLAMP X AMB V110AC GY	ELECTRA	36
63768	MNF X GRE S V240AC GY	ELECTRA	56	64120	MLAMP X RED V110AC GY	ELECTRA	36
63769	MNF X YEL S V240AC GY	ELECTRA	56	64121	MLAMP X YEL V110AC GY	ELECTRA	36
63770	MNF X CLR S V240AC GY	ELECTRA	56	64123	MLAMP X AMB V240AC GY	ELECTRA	36
63788	MNF X BLU P V12/24DAC GY	ELECTRA	56	64124	MLAMP X RED V240AC GY	ELECTRA	36
63789	MNF X AMB P V12/24DAC GY	ELECTRA	56	64125	MLAMP X GRE V240AC GY	ELECTRA	36
63790	MNF X RED P V12/24DAC GY	ELECTRA	56	64126	MLAMP X YEL V240AC GY	ELECTRA	36
63791	MNF X YEL P V12/24DAC GY	ELECTRA	56	64128	MLAMP X GRE V110AC GY	ELECTRA	36
63792	MNF X CLR P V12/24DAC GY	ELECTRA	56	64442	CTL900 X BLU V12/24DAC GY	ELECTRA	39
63793	MNF X BLU P V110AC GY	ELECTRA	56	64443	CTL900 X AMB V12/24DAC GY	ELECTRA	39
63794	MNF X AMB P V110AC GY	ELECTRA	56	64444	CTL900 X RED V12/24DAC GY	ELECTRA	39
63795	MNF X RED P V110AC GY	ELECTRA	56	64445	CTL900 X GRE V12/24DAC GY	ELECTRA	39
63796	MNF X GRE P V110AC GY	ELECTRA	56	64446	CTL900 X YEL V12/24DAC GY	ELECTRA	39
63797	MNF X YEL P V110AC GY	ELECTRA	56	64454	CTL900 X BLU V240AC GY	ELECTRA	39
63798	MNF X CLR P V110AC GY	ELECTRA	56	64455	CTL900 X AMB V240AC GY	ELECTRA	39
63799	MNF X BLU P V240AC GY	ELECTRA	56	64456	CTL900 X RED V240AC GY	ELECTRA	39
63800	MNF X AMB P V240AC GY	ELECTRA	56	64457	CTL900 X GRE V240AC GY	ELECTRA	39
63801	MNF X RED P V240AC GY	ELECTRA	56	64458	CTL900 X YEL V240AC GY	ELECTRA	39
63802	MNF X GRE P V240AC GY	ELECTRA	56	64524	CTL1200 X BLU V12/24DAC GY	ELECTRA	40
63803	MNF X YEL P V240AC GY	ELECTRA	56	64525	CTL1200 X AMB V12/24DAC GY	ELECTRA	40
63804	MNF X CLR P V240AC GY	ELECTRA	56	64526	CTL1200 X RED V12/24DAC GY	ELECTRA	40
63817	MNF X BLU E V12/24DAC GY	ELECTRA	56	64527	CTL1200 X GRE V12/24DAC GY	ELECTRA	40
63818	MNF X AMB E V12/24DAC GY	ELECTRA	56	64528	CTL1200 X YEL V12/24DAC GY	ELECTRA	40
63819	MNF X RED E V12/24DAC GY	ELECTRA	56	64530	CTL1200 X BLU V110AC GY	ELECTRA	40
63820	MNF X YEL E V12/24DAC GY	ELECTRA	56	64531	CTL1200 X AMB V110AC GY	ELECTRA	40
63821	MNF X BLU E V110AC GY	ELECTRA	56	64532	CTL1200 X RED V110AC GY	ELECTRA	40
63822	MNF X AMB E V110AC GY	ELECTRA	56	64533	CTL1200 X GRE V110AC GY	ELECTRA	40
63823	MNF X RED E V110AC GY	ELECTRA	56	64534	CTL1200 X YEL V110AC GY	ELECTRA	40
63824	MNF X GRE E V110AC GY	ELECTRA	56	64536	CTL1200 X BLU V240AC GY	ELECTRA	40
63825	MNF X YEL E V110AC GY	ELECTRA	56	64537	CTL1200 X AMB V240AC GY	ELECTRA	40
63826	MNF X CLR E V110AC GY	ELECTRA	56	64538	CTL1200 X RED V240AC GY	ELECTRA	40
63827	MNF X BLU E V240AC GY	ELECTRA	56	64539	CTL1200 X GRE V240AC GY	ELECTRA	40
63828	MNF X AMB E V240AC GY	ELECTRA	56	64540	CTL1200 X YEL V240AC GY	ELECTRA	40
63829	MNF X RED E V240AC GY	ELECTRA	56	65792	STR LED72 AMB S V24DAC BK	ELECTRA	63
63830	MNF X GRE E V240AC GY	ELECTRA	56	65793	STR LED72 RED S V24DAC BK	ELECTRA	63

Code	Description	Section	Page	Code	Description	Section	Page
65796	STR LED72 CLR S V24DAC BK	ELECTRA	63	66552	MNF LED SLR AMB S V90/240AC GY	ELECTRA	55
65822	STR LED72 AMB S V240AC BK	ELECTRA	63	66553	MNF LED SLR RED S V90/240AC GY	ELECTRA	55
65823	STR LED72 RED S V240AC BK	ELECTRA	63	66554	MNF LED SLR GRE S V90/240AC GY	ELECTRA	55
65826	STR LED72 CLR S V240AC BK	ELECTRA	63	66555	MNF LED SLR YEL S V90/240AC GY	ELECTRA	55
65832	STR LED72 AMB P V24DAC BK	ELECTRA	63	66556	MNF LED SLR CLR S V90/240AC GY	ELECTRA	55
65833	STR LED72 RED P V24DAC BK	ELECTRA	63	66580	MNF LED FLR AMB P V12/24DAC GY	ELECTRA	55
65836	STR LED72 CLR P V24DAC BK	ELECTRA	63	66581	MNF LED FLR AMB P V90/240AC GY	ELECTRA	55
65862	STR LED72 AMB P V240AC BK	ELECTRA	63	67888	NWC B LD903.00 V12D2	ICARO	327
65863	STR LED72 RED P V240AC BK	ELECTRA	63	67901	NWC B LD803.00 V12D2	ICARO	327
65866	STR LED72 CLR P V240AC BK	ELECTRA	63	69410	SMFR 6.3 LD8Q V12 DCAC	FOUR	174
65872	STR LED86 AMB S V24DAC BK	ELECTRA	63	69411	SMFR 6.3 LD8Q V24 DCAC	FOUR	174
65873	STR LED86 RED S V24DAC BK	ELECTRA	63	69412	SMFR 6.3 LD8Q V48 DCAC	FOUR	174
65876	STR LED86 CLR S V24DAC BK	ELECTRA	63	69413	SMFR 6.3 LD8Q V110 AC	FOUR	174
65902	STR LED86 AMB S V240AC BK	ELECTRA	63	69414	SMFR 6.3 LD8Q V240 AC	FOUR	174
65903	STR LED86 RED S V240AC BK	ELECTRA	63	69415	SMFR 9.3 LD16Q V12 DCAC	FOUR	176
65906	STR LED86 CLR S V240AC BK	ELECTRA	63	69416	SMFR 9.3 LD16Q V24 DCAC	FOUR	176
65912	STR LED86 AMB P V24DAC BK	ELECTRA	63	69417	SMFR 9.3 LD16Q V48 DCAC	FOUR	176
65913	STR LED86 RED P V24DAC BK	ELECTRA	63	69418	SMFR 9.3 LD16Q V110 AC	FOUR	176
65916	STR LED86 CLR P V24DAC BK	ELECTRA	63	69420	SMFR 9.3 LD16Q V240 AC	FOUR	176
65942	STR LED86 AMB P V240AC BK	ELECTRA	63	69421	SMFR 12.3 LD24Q V12 DCAC	FOUR	178
65943	STR LED86 RED P V240AC BK	ELECTRA	63	69422	SMFR 12.3 LD24Q V24 DCAC	FOUR	178
65946	STR LED86 CLR P V240AC BK	ELECTRA	63	69423	SMFR 12.3 LD24Q V48 DCAC	FOUR	178
66460	LD 12 LINEAR S/F BLU V24DAC GY	ELECTRA	83	69424	SMFR 12.3 LD24Q V110 AC	FOUR	178
66461	LD 12 LINEAR S/F AMB V24DAC GY	ELECTRA	83	69425	SMFR 12.3 LD24Q V240 AC	FOUR	178
66462	LD 12 LINEAR S/F RED V24DAC GY	ELECTRA	83	69426	SMFR 6.2 LD8Q V12 DCAC	FOUR	175
66463	LD 12 LINEAR S/F GRE V24DAC GY	ELECTRA	83	69427	SMFR 6.2 LD8Q V24 DCAC	FOUR	175
66464	LD 12 LINEAR S/F YEL V24DAC GY	ELECTRA	83	69428	SMFR 6.2 LD8Q V48 DCAC	FOUR	175
66465	LD 12 LINEAR S/F CLR V24DAC GY	ELECTRA	83	69429	SMFR 6.2 LD8Q V110 AC	FOUR	175
66466	LD 12 LINEAR S/F BLU V240AC GY	ELECTRA	83	69430	SMFR 6.2 LD8Q V240 AC	FOUR	175
66467	LD 12 LINEAR S/F AMB V240AC GY	ELECTRA	83	69431	SMFR 9.2 LD16Q V12 DCAC	FOUR	177
66468	LD 12 LINEAR S/F RED V240AC GY	ELECTRA	83	69432	SMFR 9.2 LD16Q V24 DCAC	FOUR	177
66469	LD 12 LINEAR S/F GRE V240AC GY	ELECTRA	83	69433	SMFR 9.2 LD16Q V48 DCAC	FOUR	177
66470	LD 12 LINEAR S/F YEL V240AC GY	ELECTRA	83	69434	SMFR 9.2 LD16Q V110 AC	FOUR	177
66471	LD 12 LINEAR S/F CLR V240AC GY	ELECTRA	83	69435	SMFR 9.2 LD16Q V240 AC	FOUR	177
66501	MNF LED FLR BLU S V12/24DAC GY	ELECTRA	55	69436	SMFR 12.2 LD24Q V12 DCAC	FOUR	179
66502	MNF LED FLR AMB S V12/24DAC GY	ELECTRA	55	69437	SMFR 12.2 LD24Q V24 DCAC	FOUR	179
66503	MNF LED FLR RED S V12/24DAC GY	ELECTRA	55	69438	SMFR 12.2 LD24Q V48 DCAC	FOUR	179
66504	MNF LED FLR GRE S V12/24DAC GY	ELECTRA	55	69439	SMFR 12.2 LD24Q V110 AC	FOUR	179
66505	MNF LED FLR YEL S V12/24DAC GY	ELECTRA	55	69440	SMFR 12.2 LD24Q V240 AC	FOUR	179
66506	MNF LED FLR CLR S V12/24DAC GY	ELECTRA	55	69441	SMFR 6.3 LD8Q A V12 DCAC	FOUR	174
66511	MNF LED FLR BLU S V90/240AC GY	ELECTRA	55	69442	SMFR 6.3 LD8Q A V24 DCAC	FOUR	174
66512	MNF LED FLR AMB S V90/240AC GY	ELECTRA	55	69443	SMFR 6.3 LD8Q A V48 DCAC	FOUR	174
66513	MNF LED FLR RED S V90/240AC GY	ELECTRA	55	69444	SMFR 6.3 LD8Q A V110 AC	FOUR	174
66514	MNF LED FLR GRE S V90/240AC GY	ELECTRA	55	69445	SMFR 6.3 LD8Q A V240 AC	FOUR	174
66515	MNF LED FLR YEL S V90/240AC GY	ELECTRA	55	69446	SMFR 9.3 LD16Q A V12 AC	FOUR	176
66516	MNF LED FLR CLR S V90/240AC GY	ELECTRA	55	69447	SMFR 9.3 LD16Q A V24 AC	FOUR	176
66541	MNF LED SLR BLU S V12/24DAC GY	ELECTRA	55	69448	SMFR 9.3 LD16Q A V48 AC	FOUR	176
66542	MNF LED SLR AMB S V12/24DAC GY	ELECTRA	55	69449	SMFR 9.3 LD16Q A V110 AC	FOUR	176
66543	MNF LED SLR RED S V12/24DAC GY	ELECTRA	55	69450	SMFR 9.3 LD16Q A V240 AC	FOUR	176
66544	MNF LED SLR GRE S V12/24DAC GY	ELECTRA	55	69451	SMFR 12.3 LD24Q AV12 AC	FOUR	178
66545	MNF LED SLR YEL S V12/24DAC GY	ELECTRA	55	69452	SMFR 12.3 LD24Q AV24 AC	FOUR	178
66546	MNF LED SLR CLR S V12/24DAC GY	ELECTRA	55	69453	SMFR 12.3 LD24Q AV48 AC	FOUR	178
66551	MNF LED SLR BLU S V90/240AC GY	ELECTRA	55	69454	SMFR 12.3 LD24Q AV110 AC	FOUR	178

Code	Description	Section	Page	Code	Description	Section	Page
69455	SMFR 12.3 LD24Q AV240 AC	FOUR	178	70978	BULB BA15D 10W V130 1X25PCS	ELECTRA	84
69456	SMFR 6.2 LD8Q A V12 DCAC	FOUR	175	70979	BULB BA15D 10W V240 1X25PCS	ELECTRA	84
69457	SMFR 6.2 LD8Q A V24 DCAC	FOUR	175	70980	BULB BA15D 25W V12 1X12PCS	ELECTRA	84
69458	SMFR 6.2 LD8Q A V48 DCAC	FOUR	175	70981	BULB BA15D 25W V24 1X12PCS	ELECTRA	84
69459	SMFR 6.2 LD8Q A V110 AC	FOUR	175	70982	BULB BA15D 25W V48 1X12PCS	ELECTRA	84
69460	SMFR 6.2 LD8Q A V240 AC	FOUR	175	70983	BULB BA15D 25W V130 1X12PCS	ELECTRA	84
69461	SMFR 9.2 LD16Q A V12 AC	FOUR	177	70984	BULB BA15D 25W V240 1X12PCS	ELECTRA	84
69462	SMFR 9.2 LD16Q A V24 AC	FOUR	177	70985	BULB BA15D 40W V12 1X12PCS	ELECTRA / EXPRO	84/229
69463	SMFR 9.2 LD16Q A V48 AC	FOUR	177	70986	BULB BA15D 40W V24 1X12PCS	ELECTRA / EXPRO	84/229
69464	SMFR 9.2 LD16Q A V110 AC	FOUR	177	70987	BULB BA15D 40W V48 1X12PCS	ELECTRA / EXPRO	84/229
69465	SMFR 9.2 LD16Q A V240 AC	FOUR	177	70988	BULB BA15D 40W V130 1X12PCS	ELECTRA / EXPRO	84/229
69466	SMFR 12.2 LD24Q AV12 AC	FOUR	179	70989	BULB BA15D 40W V240 1X12PCS	ELECTRA / EXPRO	84/229
69467	SMFR 12.2 LD24Q AV24 AC	FOUR	179	71090	CTL 1200 SPARE DOME BLU	ELECTRA	40
69468	SMFR 12.2 LD24Q AV48 AC	FOUR	179	71091	CTL 1200 SPARE DOME AMB	ELECTRA	40
69469	SMFR 12.2 LD24Q AV110 AC	FOUR	179	71092	CTL 1200 SPARE DOME RED	ELECTRA	40
69470	SMFR 12.2 LD24Q A V240 AC	FOUR	179	71093	CTL 1200 SPARE DOME GRE	ELECTRA	40
69569	SMFR 9.3 LD16Q A V12 DC	FOUR	176	71094	CTL 1200 SPARE DOME YEL	ELECTRA	40
69570	SMFR 9.3 LD16Q A V24 DC	FOUR	176	71098	OVOLUX SPARE DOME GRE	ELECTRA	43
69574	SMFR 12.3 LD24Q AV12 DC	FOUR	178	71099	OVOLUX SPARE DOME YEL	ELECTRA	43
69575	SMFR 12.3 LD24Q AV24 DC	FOUR	178	71100	OVOLUX SPARE DOME CLR	ELECTRA	43
69579	SMFR 9.2 LD16Q A V12 DC	FOUR	177	71115	OVOLUX SPARE DOME BLU	ELECTRA	43
69580	SMFR 9.2 LD16Q A V24 DC	FOUR	177	71116	OVOLUX SPARE DOME AMB	ELECTRA	43
69584	SMFR 12.2 LD24Q AV12 DC	FOUR	179	71117	OVOLUX SPARE DOME RED	ELECTRA	43
69585	SMFR 12.2 LD24Q AV24 DC	FOUR	179	71167	TYPE 200 SPARE DOME AMB	ELECTRA	60
70912	XENON SPARE BULB 1 JOULE	ELECTRA	84	71168	TYPE 200 SPARE DOME RED	ELECTRA	60
70941	BULB BA15D 5W V12 1PC	ELECTRA/AUTOMAX	84/164	71169	TYPE 200 SPARE DOME GRE	ELECTRA	60
70942	BULB BA15D 5W V24 1PC	ELECTRA/AUTOMAX	84/164	71172	TYPE 200 SPARE DOME YEL	ELECTRA	60
70943	BULB BA15D 5W V48 1PC	ELECTRA/AUTOMAX	84/164	71191	CTL 600 SPARE DOME AMB	ELECTRA	38
70944	BULB BA15D 5W V130 1PC	ELECTRA/AUTOMAX	84/164	71192	CTL 600 SPARE DOME RED	ELECTRA	38
70945	BULB BA15D 5W V240 1PC	ELECTRA/AUTOMAX	84/164	71193	CTL 600 SPARE DOME GRE	ELECTRA	38
70946	BULB BA15D 10W V12 1PC	ELECTRA	84	71194	CTL 600 SPARE DOME YEL	ELECTRA	38
70947	BULB BA15D 10W V24 1PC	ELECTRA	84	71196	CTL 900 SPARE DOME BLU	ELECTRA	39
70948	BULB BA15D 10W V48 1PC	ELECTRA	84	71197	CTL 900 SPARE DOME AMB	ELECTRA	39
70949	BULB BA15D 10W V130 1PC	ELECTRA	84	71198	CTL 900 SPARE DOME RED	ELECTRA	39
70950	BULB BA15D 10W V240 1PC	ELECTRA	84	71199	CTL 900 SPARE DOME GRE	ELECTRA	39
70951	BULB BA15D 25W V12 1PC	ELECTRA	84	71200	CTL 900 SPARE DOME YEL	ELECTRA	39
70952	BULB BA15D 25W V24 1PC	ELECTRA	84	71293	FAROLAMP SPARE DOME YEL	ELECTRA	61/62
70953	BULB BA15D 25W V48 1PC	ELECTRA	84	71300	RA FLUTED SPARE DOME AMB	ELECTRA	48/49/51/53
70954	BULB BA15D 25W V130 1PC	ELECTRA	84	71301	RA FLUTED SPARE DOME BLU	ELECTRA	48/49/51/53
70955	BULB BA15D 25W V240 1PC	ELECTRA	84	71303	RA FLUTED SPARE DOME RED	ELECTRA	48/49/51/53
70956	BULB BA15D 40W V12 1PC	ELECTRA / EXPRO	84/229	71304	RA FLUTED SPARE DOME GRE	ELECTRA	48/49/51/53
70957	BULB BA15D 40W V24 1PC	ELECTRA / EXPRO	84/229	71305	RA SMOOTH SPARE DOME AMB	ELECTRA	51/53
70958	BULB BA15D 40W V48 1PC	ELECTRA / EXPRO	84/229	71306	RA SMOOTH SPARE DOME BLU	ELECTRA	51/53
70959	BULB BA15D 40W V130 1PC	ELECTRA / EXPRO	84/229	71308	RA SMOOTH SPARE DOME RED	ELECTRA	51/53
70960	BULB BA15D 40W V240 1PC	ELECTRA / EXPRO	84/229	71309	RA SMOOTH SPARE DOME GRE	ELECTRA	51/53
70970	BULB BA15D 5W V12 1X25PCS	ELECTRA/AUTOMAX	84/164	71310	MLAMP SPARE DOME AMB	ELECTRA	36
70971	BULB BA15D 5W V24 1X25PCS	ELECTRA/AUTOMAX	84/164	71313	MLAMP SPARE DOME RED	ELECTRA	36
70972	BULB BA15D 5W V48 1X25PCS	ELECTRA/AUTOMAX	84/164	71314	MLAMP SPARE DOME GRE	ELECTRA	36
70973	BULB BA15D 5W V130 1X25PCS	ELECTRA/AUTOMAX	84/164	71315	MINIFLASH SPARE DOME AMB	ELECTRA	55/56
70974	BULB BA15D 5W V240 1X25PCS	ELECTRA/AUTOMAX	84/164	71316	MINIFLASH SPARE DOME RED	ELECTRA	55/56
70975	BULB BA15D 10W V12 1X25PCS	ELECTRA	84	71317	MINIFLASH SPARE DOME CLR	ELECTRA	55/56
70976	BULB BA15D 10W V24 1X25PCS	ELECTRA	84	71318	MINIFLASH SPARE DOME BLU	ELECTRA	55/56
70977	BULB BA15D 10W V48 1X25PCS	ELECTRA	84	71319	MINIFLASH SPARE DOME GRE	ELECTRA	55/56

Code	Description	Section	Page	Code	Description	Section	Page
71320	MAXIFLASH SPARE DOME AMB	ELECTRA	58/59	79605	MLAMP S/F YEL V12/48DC GY	ELECTRA	36
71323	MAXIFLASH SPARE DOME RED	ELECTRA	58/59	79612	MLAMP S/F AMB V24/240AC GY	ELECTRA	36
71324	MAXIFLASH SPARE DOME GRE	ELECTRA	58/59	79613	MLAMP S/F RED V24/240AC GY	ELECTRA	36
71325	FAROLAMP SPARE DOME AMB	ELECTRA	61/62	79614	MLAMP S/F GRE V24/240AC GY	ELECTRA	36
71328	FAROLAMP SPARE DOME RED	ELECTRA	61/62	79615	MLAMP S/F YEL V24/240AC GY	ELECTRA	36
71329	FAROLAMP SPARE DOME GRE	ELECTRA	61/62	79722	MLAMP S/F A AMB V12DAC GY	ELECTRA	36
71330	RA FLUTED SPARE DOME YEL	ELECTRA	48/49/51/53	79723	MLAMP S/F A RED V12DAC GY	ELECTRA	36
71331	RA SMOOTH SPARE DOME YEL	ELECTRA	51/53	79724	MLAMP S/F A GRE V12DAC GY	ELECTRA	36
71332	MLAMP SPARE DOME YEL	ELECTRA	36	79725	MLAMP S/F A YEL V12DAC GY	ELECTRA	36
71333	MINIFLASH SPARE DOME YEL	ELECTRA	55/56	79732	MLAMP S/F A AMB V24DAC GY	ELECTRA	36
71334	MAXIFLASH SPARE DOME YEL	ELECTRA	58/59	79733	MLAMP S/F A RED V24DAC GY	ELECTRA	36
71385	STR SPARE DOME AMB	ELECTRA	63	79734	MLAMP S/F A GRE V24DAC GY	ELECTRA	36
71387	STR SPARE DOME CLR	ELECTRA	63	79735	MLAMP S/F A YEL V24DAC GY	ELECTRA	36
71388	STR SPARE DOME RED	ELECTRA	63	79742	MLAMP S/F A AMB V48DAC GY	ELECTRA	36
71600	BULB BA15S 45W V12DC 1PC	ELECTRA / EXPRO	84/229	79743	MLAMP S/F A RED V48DAC GY	ELECTRA	36
71601	BULB BA15S 45W V24DC 1PC	ELECTRA / EXPRO	84/229	79744	MLAMP S/F A GRE V48DAC GY	ELECTRA	36
71602	BULB H1 55W V12 1PC	ELECTRA / EXPRO	84/229	79745	MLAMP S/F A YEL V48DAC GY	ELECTRA	36
71603	BULB H1 70W V24 1PC	ELECTRA / EXPRO	84/229	79752	MLAMP S/F A AMB V110AC GY	ELECTRA	36
71606	BULB BA15S 45W V48DC 1PC	ELECTRA	84	79753	MLAMP S/F A RED V110AC GY	ELECTRA	36
71625	BULB E14T 25W V110AC 1PC	ELECTRA / EXPRO	84/229	79754	MLAMP S/F A GRE V110AC GY	ELECTRA	36
71634	XENON SPARE BULB 2 JOULE	ELECTRA/AUTOMAX	84/164	79755	MLAMP S/F A YEL V110AC GY	ELECTRA	36
71638	XENON SPARE BULB 15 JOULE	ELECTRA / EXPRO	84/229	79772	MLAMP S/F A AMB V240AC GY	ELECTRA	36
71639	XENON SPARE BULB 6 JOULE	ELECTRA	84	79773	MLAMP S/F A RED V240AC GY	ELECTRA	36
71640	BULB E14T 25W V240AC 1PC	ELECTRA / EXPRO	84/229	79774	MLAMP S/F A GRE V240AC GY	ELECTRA	36
71663	BULB E14T 25W V48AC 1PC	ELECTRA	84	79775	MLAMP S/F A YEL V240AC GY	ELECTRA	36
71690	ROTALLARM HD GRID	ELECTRA	49/54	79782	MLAMP STY AMB V12/240DAC GY	ELECTRA	36
71693	STR GRID	ELECTRA	63	79783	MLAMP STY RED V12/240DAC GY	ELECTRA	36
71818	ROTALLARM HD WALL BASE	ELECTRA	49/54	79784	MLAMP STY GRE V12/240DAC GY	ELECTRA	36
72625	SUPPORTO BASE LUXOR 4	AUTOMAX	168	79785	MLAMP STY YEL V12/240DAC GY	ELECTRA	36
72626	CIRC.+SCH.SMD LX4 071F 324	AUTOMAX	167	82200	ROTALLARM HD AMB V12DAC BK	ELECTRA	53
72627	CIRC.+SCH.SMD LX4 071F 423	AUTOMAX	167	82201	ROTALLARM HD BLU V12DAC BK	ELECTRA	53
72673	PR4 A	AUTOMAX	168	82203	ROTALLARM HD RED V12DAC BK	ELECTRA	53
72683	BT 4	AUTOMAX	168	82204	ROTALLARM HD GRE V12DAC BK	ELECTRA	53
72692	WALL BASE GRAY	ELECTRA	48/51/55/56/58/59/60	82210	ROTALLARM HD AMB V24DAC BK	ELECTRA	53
72731	DIFFUSORE LX4 2	AUTOMAX	167	82211	ROTALLARM HD BLU V24DAC BK	ELECTRA	53
72732	DIFFUSORE LX4 3	AUTOMAX	167	82213	ROTALLARM HD RED V24DAC BK	ELECTRA	53
72733	DIFFUSORE LX4 4	AUTOMAX	167	82214	ROTALLARM HD GRE V24DAC BK	ELECTRA	53
72745	BULB BA15D 40W V12 12PCS	ELECTRA / EXPRO	84/229	82225	ROTALLARM HD AMB V110AC BK	ELECTRA	53
72746	BULB BA15D 40W V24 12PCS	ELECTRA / EXPRO	84/229	82226	ROTALLARM HD BLU V110AC BK	ELECTRA	53
72747	BULB BA15D 40W V48 12PCS	ELECTRA / EXPRO	84/229	82228	ROTALLARM HD RED V110AC BK	ELECTRA	53
72748	BULB BA15D 40W V130 12PCS	ELECTRA / EXPRO	84/229	82229	ROTALLARM HD GRE V110AC BK	ELECTRA	53
72749	BULB BA15D 40W V240 12PCS	ELECTRA / EXPRO	84/229	82240	ROTALLARM HD AMB V240AC BK	ELECTRA	53
72773	BULB BA15D 25W V12 12PCS	ELECTRA	84	82241	ROTALLARM HD BLU V240AC BK	ELECTRA	53
72774	BULB BA15D 25W V24 12PCS	ELECTRA	84	82243	ROTALLARM HD RED V240AC BK	ELECTRA	53
72775	BULB BA15D 25W V48 12PCS	ELECTRA	84	82244	ROTALLARM HD GRE V240AC BK	ELECTRA	53
72776	BULB BA15D 25W V130 12PCS	ELECTRA	84	82247	ROTALLARM HD YEL V110AC BK	ELECTRA	53
72777	BULB BA15D 25W V240 12PCS	ELECTRA	84	82250	ROTALLARM HD AMB V12DAC H1 BK	ELECTRA	53
74907	INDICATOR 7 V12/24DC AMB	WORKPLUS	190	82251	ROTALLARM HD BLU V12DAC H1 BK	ELECTRA	53
74908	INDICATOR 9 V12/24DC AMB	WORKPLUS	190	82253	ROTALLARM HD RED V12DAC H1 BK	ELECTRA	53
74909	T PLUS V12/24DC	WORKPLUS	198	82254	ROTALLARM HD GRE V12DAC H1 BK	ELECTRA	53
79602	MLAMP S/F AMB V12/48DC GY	ELECTRA	36	82256	ROTALLARM HD YEL V12DAC H1 BK	ELECTRA	53
79603	MLAMP S/F RED V12/48DC GY	ELECTRA	36	82260	ROTALLARM HD AMB V24DAC H1 BK	ELECTRA	53
79604	MLAMP S/F GRE V12/48DC GY	ELECTRA	36	82261	ROTALLARM HD BLU V24DAC H1 BK	ELECTRA	53

Code	Description	Section	Page	Code	Description	Section	Page
82263	ROTALLARM HD RED V24DAC H1 BK	ELECTRA	53	84765	RA HD X YEL V110AC BK	ELECTRA	53
82264	ROTALLARM HD GRE V24DAC H1 BK	ELECTRA	53	84771	RA HD X BLU V240AC BK	ELECTRA	53
82270	ROTALLARM HD YEL V12DAC BK	ELECTRA	53	84772	RA HD X AMB V240AC BK	ELECTRA	53
82271	ROTALLARM HD YEL V24DAC BK	ELECTRA	53	84773	RA HD X RED V240AC BK	ELECTRA	53
82273	ROTALLARM HD YEL V24DAC H1 BK	ELECTRA	53	84774	RA HD X GRE V240AC BK	ELECTRA	53
82274	ROTALLARM HD YEL V240AC BK	ELECTRA	53	84775	RA HD X YEL V240AC BK	ELECTRA	53
82401	RA S FLA BLU V12DAC H1 GY	ELECTRA	51	84968	FAROLAMP X S V12/24DAC YEL	ELECTRA	62
82402	RA S FLA AMB V12DAC H1 GY	ELECTRA	51	84970	FAROLAMP X S V12/24DAC AMB	ELECTRA / ESCAPE	62/280
82403	RA S FLA RED V12DAC H1 GY	ELECTRA	51	84971	FAROLAMP X S V240AC AMB	ELECTRA	62
82404	RA S FLA GRE V12DAC H1 GY	ELECTRA	51	84978	FAROLAMP X P V12/24DAC AMB	ELECTRA	62
82405	RA S FLA YEL V12DAC H1 GY	ELECTRA	51	84979	FAROLAMP X P V240AC AMB	ELECTRA	62
82421	RA S FLA BLU V24DAC H1 GY	ELECTRA	51	84982	FAROLAMP X P V240AC RED	ELECTRA	62
82422	RA S FLA AMB V24DAC H1 GY	ELECTRA	51	84992	FAROLAMP X S V240AC YEL	ELECTRA	62
82423	RA S FLA RED V24DAC H1 GY	ELECTRA	51	84995	FAROLAMP X P V240AC YEL	ELECTRA	62
82424	RA S FLA GRE V24DAC H1 GY	ELECTRA	51	85033	FAROLAMP X P V12/24DAC RED	ELECTRA	62
82425	RA S FLA YEL V24DAC H1 GY	ELECTRA	51	85037	FAROLAMP X P V12/24DAC YEL	ELECTRA	62
82441	RA HD FLA BLU V12DAC H1 BK	ELECTRA	53	85044	FAROLAMP X S V12/24DAC RED	ELECTRA / ESCAPE	62/280
82442	RA HD FLA AMB V12DAC H1 BK	ELECTRA	53	85049	FAROLAMP X P V12/24DAC GRE	ELECTRA	62
82443	RA HD FLA RED V12DAC H1 BK	ELECTRA	53	85078	FAROLAMP LED FA V24DC P RED	ESCAPE	281
82444	RA HD FLA GRE V12DAC H1 BK	ELECTRA	53	85079	FAROLAMP LED FA V24DC P CLR	ESCAPE	281
82445	RA HD FLA YEL V12DAC H1 BK	ELECTRA	53	85092	FAROLAMP LED S V12/24DAC AMB	ELECTRA	61
82461	RA HD FLA BLU V24DAC H1 BK	ELECTRA	53	85093	FAROLAMP LED S V12/24DAC RED	ELECTRA	61
82462	RA HD FLA AMB V24DAC H1 BK	ELECTRA	53	85094	FAROLAMP LED S V12/24DAC GRE	ELECTRA	61
82463	RA HD FLA RED V24DAC H1 BK	ELECTRA	53	85095	FAROLAMP LED S V12/24DAC YEL	ELECTRA	61
82464	RA HD FLA GRE V24DAC H1 BK	ELECTRA	53	85160	FAROLAMP X P V240AC GRE	ELECTRA	62
82465	RA HD FLA YEL V24DAC H1 BK	ELECTRA	53	85225	FAROLAMP LED P V12/24DAC AMB	ELECTRA	61
83001	SPINOTTO S	WORKPLUS	204	85226	FAROLAMP LED P V12/24DAC RED	ELECTRA	61
83002	SPINOTTO B	WORKPLUS	204	85227	FAROLAMP LED P V12/24DAC GRE	ELECTRA	61
83005	ROTALLARM S P BASE	ELECTRA	48/51	85228	FAROLAMP LED P V12/24DAC YEL	ELECTRA	61
83036	SPINOTTO SP	WORKPLUS	204	85271	FAROLAMP X S V240AC RED	ELECTRA	62
83039	PROLUNGA SPR	WORKPLUS	205	85370	FAROLAMP X S V12/24DAC GRE	ELECTRA / ESCAPE	62/280
83040	PROLUNGA TELESCOPICA SPRT	WORKPLUS	205	85371	FAROLAMP X S V240AC GRE	ELECTRA	62
83055	STR SPARE P BASE	ELECTRA	63	85411	RA S X BLU V12/24DAC GY	ELECTRA	51
83066	MLAMP P BASE GY	ELECTRA	36	85412	RA S X AMB V12/24DAC GY	ELECTRA	51
83067	MLAMP E BASE GY	ELECTRA	36	85413	RA S X RED V12/24DAC GY	ELECTRA	51
83498	SPINOTTO SL	WORKPLUS	204	85414	RA S X GRE V12/24DAC GY	ELECTRA	51
83508	SPINOTTO FZ	WORKPLUS	204	85415	RA S X YEL V12/24DAC GY	ELECTRA	51
83509	SPINOTTO FZP	WORKPLUS	204	85421	RA S X BLU V110AC GY	ELECTRA	51
83510	SPINOTTO SPL/I	WORKPLUS	205	85422	RA S X AMB V110AC GY	ELECTRA	51
83511	SPINOTTO SPL/D	WORKPLUS	205	85423	RA S X RED V110AC GY	ELECTRA	51
84080	GRUPPO BATTENTE SIAD/SIADEL 165	EXPRO	216	85424	RA S X GRE V110AC GY	ELECTRA	51
84081	GRUPPO BATTENTE SIAD/SIADEL 215	EXPRO	216	85425	RA S X YEL V110AC GY	ELECTRA	51
84667	FORK PLUS V10/100DC AMB	WORKPLUS	199	85431	RA S X BLU V240AC GY	ELECTRA	51
84668	INDIGO SAFE PATH V10/100DC BLU	WORKPLUS	200	85432	RA S X AMB V240AC GY	ELECTRA	51
84751	RA HD X BLU V12/24DAC BK	ELECTRA	53	85433	RA S X RED V240AC GY	ELECTRA	51
84752	RA HD X AMB V12/24DAC BK	ELECTRA	53	85434	RA S X GRE V240AC GY	ELECTRA	51
84753	RA HD X RED V12/24DAC BK	ELECTRA	53	85435	RA S X YEL V240AC GY	ELECTRA	51
84754	RA HD X GRE V12/24DAC BK	ELECTRA	53	87759	STR X 15J RED S V240AC BK	ELECTRA	63
84755	RA HD X YEL V12/24DAC BK	ELECTRA	53	87760	STR X 15J AMB S V240AC BK	ELECTRA	63
84761	RA HD X BLU V110AC BK	ELECTRA	53	87763	STR X 15J CLR S V240AC BK	ELECTRA	63
84762	RA HD X AMB V110AC BK	ELECTRA	53	87767	STR X 15J AMB P V240AC BK	ELECTRA	63
84763	RA HD X RED V110AC BK	ELECTRA	53	87768	STR X 15J RED P V240AC BK	ELECTRA	63
84764	RA HD X GRE V110AC BK	ELECTRA	53	87771	STR X 15J CLR P V240AC BK	ELECTRA	63

Code	Description	Section	Page	Code	Description	Section	Page
89111	MNF STY BLU S V12/240DAC GY	ELECTRA	56	89333	MXF S/F RED S V12/48DC GY	ELECTRA	59
89112	MNF STY AMB S V12/240DAC GY	ELECTRA	56	89334	MXF S/F GRE S V12/48DC GY	ELECTRA	59
89113	MNF STY RED S V12/240DAC GY	ELECTRA	56	89335	MXF S/F YEL S V12/48DC GY	ELECTRA	59
89114	MNF STY GRE S V12/240DAC GY	ELECTRA	56	89342	MXF S/F AMB S V24/240AC GY	ELECTRA	59
89115	MNF STY YEL S V12/240DAC GY	ELECTRA	56	89343	MXF S/F RED S V24/240AC GY	ELECTRA	59
89116	MNF STY CLR S V12/240DAC GY	ELECTRA	56	89344	MXF S/F GRE S V24/240AC GY	ELECTRA	59
89131	MNF STY BLU P V12/240DAC GY	ELECTRA	56	89345	MXF S/F YEL S V24/240AC GY	ELECTRA	59
89132	MNF STY AMB P V12/240DAC GY	ELECTRA	56	89451	RA S S/F BLU V12/48DC GY	ELECTRA	51
89133	MNF STY RED P V12/240DAC GY	ELECTRA	56	89452	RA S S/F AMB V12/48DC GY	ELECTRA	51
89134	MNF STY GRE P V12/240DAC GY	ELECTRA	56	89453	RA S S/F RED V12/48DC GY	ELECTRA	51
89135	MNF STY YEL P V12/240DAC GY	ELECTRA	56	89454	RA S S/F GRE V12/48DC GY	ELECTRA	51
89136	MNF STY CLR P V12/240DAC GY	ELECTRA	56	89455	RA S S/F YEL V12/48DC GY	ELECTRA	51
89151	MNF STY BLU E V12/240DAC GY	ELECTRA	56	89461	RA S S/F BLU V24/240AC GY	ELECTRA	51
89152	MNF STY AMB E V12/240DAC GY	ELECTRA	56	89462	RA S S/F AMB V24/240AC GY	ELECTRA	51
89153	MNF STY RED E V12/240DAC GY	ELECTRA	56	89463	RA S S/F RED V24/240AC GY	ELECTRA	51
89154	MNF STY GRE E V12/240DAC GY	ELECTRA	56	89464	RA S S/F GRE V24/240AC GY	ELECTRA	51
89155	MNF STY YEL E V12/240DAC GY	ELECTRA	56	89465	RA S S/F YEL V24/240AC GY	ELECTRA	51
89156	MNF STY CLR E V12/240DAC GY	ELECTRA	56	89491	RA HD S/F BLU V12/48DC BK	ELECTRA	53
89171	MNF S/F BLU S V12/48DC GY	ELECTRA	56	89492	RA HD S/F AMB V12/48DC BK	ELECTRA	53
89172	MNF S/F AMB S V12/48DC GY	ELECTRA	56	89493	RA HD S/F RED V12/48DC BK	ELECTRA	53
89173	MNF S/F RED S V12/48DC GY	ELECTRA	56	89494	RA HD S/F GRE V12/48DC BK	ELECTRA	53
89174	MNF S/F GRE S V12/48DC GY	ELECTRA	56	89495	RA HD S/F YEL V12/48DC BK	ELECTRA	53
89175	MNF S/F YEL S V12/48DC GY	ELECTRA	56	89511	RA HD S/F BLU V24/240AC BK	ELECTRA	53
89176	MNF S/F CLR S V12/48DC GY	ELECTRA	56	89512	RA HD S/F AMB V24/240AC BK	ELECTRA	53
89181	MNF S/F BLU S V24/240AC GY	ELECTRA	56	89513	RA HD S/F RED V24/240AC BK	ELECTRA	53
89182	MNF S/F AMB S V24/240AC GY	ELECTRA	56	89514	RA HD S/F GRE V24/240AC BK	ELECTRA	53
89183	MNF S/F RED S V24/240AC GY	ELECTRA	56	89515	RA HD S/F YEL V24/240AC BK	ELECTRA	53
89184	MNF S/F GRE S V24/240AC GY	ELECTRA	56	89611	MNF S/F BLU E V12/48DC GY	ELECTRA	56
89185	MNF S/F YEL S V24/240AC GY	ELECTRA	56	89612	MNF S/F AMB E V12/48DC GY	ELECTRA	56
89186	MNF S/F CLR S V24/240AC GY	ELECTRA	56	89613	MNF S/F RED E V12/48DC GY	ELECTRA	56
89211	MNF S/F BLU P V12/48DC GY	ELECTRA	56	89614	MNF S/F GRE E V12/48DC GY	ELECTRA	56
89212	MNF S/F AMB P V12/48DC GY	ELECTRA	56	89615	MNF S/F YEL E V12/48DC GY	ELECTRA	56
89213	MNF S/F RED P V12/48DC GY	ELECTRA	56	89616	MNF S/F CLR E V12/48DC GY	ELECTRA	56
89214	MNF S/F GRE P V12/48DC GY	ELECTRA	56	89617	MNF X GRE E V12/24DAC GY	ELECTRA	56
89215	MNF S/F YEL P V12/48DC GY	ELECTRA	56	89618	MNF X CLR E V12/24DAC GY	ELECTRA	56
89216	MNF S/F CLR P V12/48DC GY	ELECTRA	56	90061	RA S LED BLU V12/24DAC GY	ELECTRA	48
89221	MNF S/F BLU P V24/240AC GY	ELECTRA	56	90062	RA S LED AMB V12/24DAC GY	ELECTRA	48
89222	MNF S/F AMB P V24/240AC GY	ELECTRA	56	90063	RA S LED RED V12/24DAC GY	ELECTRA	48
89223	MNF S/F RED P V24/240AC GY	ELECTRA	56	90064	RA S LED GRE V12/24DAC GY	ELECTRA	48
89224	MNF S/F GRE P V24/240AC GY	ELECTRA	56	90065	RA S LED YEL V12/24DAC GY	ELECTRA	48
89225	MNF S/F YEL P V24/240AC GY	ELECTRA	56	90081	RA S LED BLU V90/240AC GY	ELECTRA	48
89226	MNF S/F CLR P V24/240AC GY	ELECTRA	56	90082	RA S LED AMB V90/240AC GY	ELECTRA	48
89251	MNF S/F BLU E V24/240AC GY	ELECTRA	56	90083	RA S LED RED V90/240AC GY	ELECTRA	48
89252	MNF S/F AMB E V24/240AC GY	ELECTRA	56	90084	RA S LED GRE V90/240AC GY	ELECTRA	48
89253	MNF S/F RED E V24/240AC GY	ELECTRA	56	90085	RA S LED YEL V90/240AC GY	ELECTRA	48
89254	MNF S/F GRE E V24/240AC GY	ELECTRA	56	90121	FLR S BLUE allCLEAR	MLINE	104
89255	MNF S/F YEL E V24/240AC GY	ELECTRA	56	90122	FLR S AMBER allCLEAR	MLINE	104
89256	MNF S/F CLR E V24/240AC GY	ELECTRA	56	90123	FLR S RED allCLEAR	MLINE	104
89272	MXF STEADY AMB S V12/240DAC GY	ELECTRA	59	90124	FLR S GREEN allCLEAR	MLINE	104
89273	MXF STEADY RED S V12/240DAC GY	ELECTRA	59	90125	SLR FA EN54-23 WHITE	MLINE / ESCAPE	118/272
89274	MXF STEADY GRE S V12/240DAC GY	ELECTRA	59	90126	SLR FA RED	MLINE / ESCAPE	118/272
89275	MXF STEADY YEL S V12/240DAC GY	ELECTRA	59	90127	XLF FA EN54-23 WHITE	MLINE / ESCAPE	119/273
89332	MXF S/F AMB S V12/48DC GY	ELECTRA	59	90128	XLF FA RED	MLINE / ESCAPE	119/273

Code	Description	Section	Page	Code	Description	Section	Page
90131	SIR-E LED BLUE aIICLEAR	MLINE	108	90347	BASE LT WALL V12/24DAC RD	MLINE / ESCAPE	120/274
90132	SIR-E LED AMBER aIICLEAR	MLINE	108	90348	BASE LT WALL V12/24DAC WH	MLINE / ESCAPE	120/274
90133	SIR-E LED RED aIICLEAR	MLINE	108	90349	BASE LT FLUSH V12/24DAC RD	MLINE / ESCAPE	121/275
90134	SIR-E LED GREEN aIICLEAR	MLINE	108	90351	FLR S BLUE aIICOLOR	MLINE	104
90135	SIR-E LED WHITE	MLINE	108	90352	FLR S AMBER aIICOLOR	MLINE	104
90139	FLR S WHITE	MLINE	104	90353	FLR S RED aIICOLOR	MLINE	104
90140	SIR-E LED MAX WHITE	MLINE	109	90354	FLR S GREEN aIICOLOR	MLINE	104
90141	XLF S PROXIMITY BLU aIICLEAR	MLINE	110	90357	SIR-E BLACK	MLINE	106
90142	XLF S PROXIMITY AMB aIICLEAR	MLINE	110	90358	SIR-E RED	MLINE	106
90143	XLF S PROXIMITY RED aIICLEAR	MLINE	110	90359	SIR-E WHITE	MLINE	106
90144	XLF S PROXIMITY GRE aIICLEAR	MLINE	110	90360	SIR-E GRAY	MLINE	106
90145	ROTATOR POLE V12DC AMB	WORKPLUS	193	90361	SIR-E LED BLUE aIICOLOR	MLINE	108
90146	ROTATOR POLE V24DC AMB	WORKPLUS	193	90362	SIR-E LED AMBER aIICOLOR	MLINE	108
90151	XLF S DIRECTIONAL BLU aIICLEAR	MLINE	110	90363	SIR-E LED RED aIICOLOR	MLINE	108
90152	XLF S DIRECTIONAL AMB aIICLEAR	MLINE	110	90364	SIR-E LED GREEN aIICOLOR	MLINE	108
90153	XLF S DIRECTIONAL RED aIICLEAR	MLINE	110	90367	BASE LT SHALLOW V12/24DAC GY	MLINE	120
90154	XLF S DIRECTIONAL GRE aIICLEAR	MLINE	110	90368	BASE LT DEEP V12/24DAC GY	MLINE	120
90155	XLF PROXIMITY MULTICOLOR RGB	MLINE	111	90369	BASE HT DEEP V120/240AC GY	MLINE	120
90156	XLF DIRECTIONAL MULTICOLOR RGB	MLINE	111	90370	BASE LT WALL V12/24DAC GY	MLINE	120
90160	ROTATOR FLEXI V12DC AMB	WORKPLUS	193	90371	BASE HT WALL V120/240AC GY	MLINE	120
90161	ROTATOR FLEXI V24DC AMB	WORKPLUS	193	90372	BASE LT DOUBLE V12/24DAC GY	MLINE	121
90162	ROTATOR DIN B V12DC AMB	WORKPLUS	193	90373	BASE LT DOUBLE V12/24DAC RD	MLINE / ESCAPE	121/275
90163	ROTATOR DIN B V24DC AMB	WORKPLUS	193	90374	BASE LT DOUBLE V12/24DAC WH	MLINE / ESCAPE	121/275
90164	ROTATOR DIN A V12DC AMB	WORKPLUS	193	90375	BASE LT FLUSH V12/24DAC WH	MLINE / ESCAPE	121/275
90165	ROTATOR DIN A V24DC AMB	WORKPLUS	193	90376	BASE HT FLUSH V120/240AC WH	MLINE	121
90166	ROTATOR MAGNETIC V12DC AMB	WORKPLUS	193	90377	SIR-E FA EN54-3 WHITE	MLINE / ESCAPE	116/270
90167	ROTATOR MAGNETIC V24DC AMB	WORKPLUS	193	90378	SIR-E FA EN54-3 RED	MLINE / ESCAPE	116/270
90176	ROTATOR MV V12DC AMB	WORKPLUS	193	90379	SIR-E LED FA EN54-3 WHITE	MLINE / ESCAPE	117/271
90177	ROTATOR MV V24DC AMB	WORKPLUS	193	90380	SIR-E LED FA EN54-3 RED	MLINE / ESCAPE	117/271
90181	RA HD LED BLU V12/24DAC BK	ELECTRA	49	90407	SIR-E MAX GRAY	MLINE	107
90182	RA HD LED AMB V12/24DAC BK	ELECTRA	49	90408	SIR-E MAX BLACK	MLINE	107
90183	RA HD LED RED V12/24DAC BK	ELECTRA	49	90409	SIR-E MAX WHITE	MLINE	107
90184	RA HD LED GRE V12/24DAC BK	ELECTRA	49	90410	SIR-E MAX RED	MLINE	107
90185	RA HD LED YEL V12/24DAC BK	ELECTRA	49	90432	BASE MT DEEP V40/80DAC GY	MLINE	120
90191	RA HD LED BLU V90/240AC BK	ELECTRA	49	90433	BASE MT WALL V40/80DAC GY	MLINE	120
90192	RA HD LED AMB V90/240AC BK	ELECTRA	49	90435	BASE MT DOUBLE V40/80DAC GY	MLINE	121
90193	RA HD LED RED V90/240AC BK	ELECTRA	49	90437	BASE MT DEEP V40/80DAC WH	MLINE	120
90194	RA HD LED GRE V90/240AC BK	ELECTRA	49	90438	BASE MT WALL V40/80DAC WH	MLINE	120
90195	RA HD LED YEL V90/240AC BK	ELECTRA	49	90439	BASE MT FLUSH V40/80DAC WH	MLINE	121
90221	RA WP LED BLU V12/24DAC SS	ELECTRA	50	90440	BASE MT DOUBLE V40/80DAC WH	MLINE	121
90222	RA WP LED AMB V12/24DAC SS	ELECTRA	50	90442	BASE MT DEEP V40/80DAC RD	MLINE	120
90223	RA WP LED RED V12/24DAC SS	ELECTRA	50	90443	BASE MT WALL V40/80DAC RD	MLINE	120
90224	RA WP LED GRE V12/24DAC SS	ELECTRA	50	90444	BASE MT FLUSH V40/80DAC RD	MLINE	121
90225	RA WP LED YEL V12/24DAC SS	ELECTRA	50	90445	BASE MT DOUBLE V40/80DAC RD	MLINE	121
90231	RA WP LED BLU V90/240AC SS	ELECTRA	50	90446	BASE HT FLUSH V120/240AC RD	MLINE	121
90232	RA WP LED AMB V90/240AC SS	ELECTRA	50	90451	BASE LT SHALLOW V12/24DAC BK	MLINE	120
90233	RA WP LED RED V90/240AC SS	ELECTRA	50	90452	BASE LT DEEP V12/24DAC BK	MLINE	120
90234	RA WP LED GRE V90/240AC SS	ELECTRA	50	90453	BASE LT WALL V12/24DAC BK	MLINE	120
90235	RA WP LED YEL V90/240AC SS	ELECTRA	50	90454	BASE LT DOUBLE V12/24DAC BK	MLINE	121
90343	BASE LT SHALLOW V12/24DAC RD	MLINE / ESCAPE	120/274	90455	BASE MT DEEP V40/80DAC BK	MLINE	120
90344	BASE LT SHALLOW V12/24DAC WH	MLINE / ESCAPE	120/274	90456	BASE MT WALL V40/80DAC BK	MLINE	120
90345	BASE LT DEEP V12/24DAC RD	MLINE / ESCAPE	120/274	90457	BASE MT DOUBLE V40/80DAC BK	MLINE	121
90346	BASE LT DEEP V12/24DAC WH	MLINE / ESCAPE	120/274	90458	BASE HT DEEP V120/240AC BK	MLINE	120

Code	Description	Section	Page	Code	Description	Section	Page
90459	BASE HT WALL V120/240AC BK	MLINE	120	90628	BASE LT POLE PNP V12/24DC RD	MLINE / ESCAPE	121/275
90460	BASE HT DOUBLE V120/240AC BK	MLINE	121	90821	XLF S DIRECTIONAL BLU allCOLOR	MLINE	110
90501	XLF S PROXIMITY BLU allCOLOR	MLINE	110	90822	XLF S DIRECTIONAL AMB allCOLOR	MLINE	110
90502	XLF S PROXIMITY AMB allCOLOR	MLINE	110	90823	XLF S DIRECTIONAL RED allCOLOR	MLINE	110
90503	XLF S PROXIMITY RED allCOLOR	MLINE	110	90824	XLF S DIRECTIONAL GRE allCOLOR	MLINE	110
90504	XLF S PROXIMITY GRE allCOLOR	MLINE	110	90826	XLF S DIRECTIONAL WHITE	MLINE	110
90506	XLF S PROXIMITY WHITE	MLINE	110	90847	XLF DIRECTIONAL MULTICOLOR RGA	MLINE	112
90507	XLF PROXIMITY MULTICOLOR RGA	MLINE	112	90851	SLR S BLUE allCOLOR	MLINE	105
90508	BASE HT DEEP V120/240AC RD	MLINE	120	90852	SLR S AMBER allCOLOR	MLINE	105
90509	BASE HT DEEP V120/240AC WH	MLINE	120	90853	SLR S RED allCOLOR	MLINE	105
90510	BASE HT WALL V120/240AC RD	MLINE	120	90854	SLR S GREEN allCOLOR	MLINE	105
90511	BASE HT WALL V120/240AC WH	MLINE	120	90856	SLR S WHITE	MLINE	105
90512	BASE HT DOUBLE V120/240AC GY	MLINE	121	90861	SLR S BLUE allCLEAR	MLINE	105
90513	BASE HT DOUBLE V120/240AC RD	MLINE	121	90862	SLR S AMBER allCLEAR	MLINE	105
90514	BASE HT DOUBLE V120/240AC WH	MLINE	121	90863	SLR S RED allCLEAR	MLINE	105
90551	MLINE STAINLESS HD GRID SIZE 1	MLINE	122	90864	SLR S GREEN allCLEAR	MLINE	105
90552	MLINE STAINLESS HD GRID SIZE 2	MLINE	122	90883	ROTALLARM GRID (P BASE)	ELECTRA	48/51
90553	MLINE STAINLESS HD GRID SIZE 3	MLINE	122	90960	ROTATOR LED B V12/24DC AMB	WORKPLUS	192
90554	MLINE STAINLESS HD GRID SIZE 4	MLINE	122	90961	ROTATOR LED A V12/24DC AMB	WORKPLUS	192
90555	BASE POLE 1 NPT-F ADAPTER	MLINE / ESCAPE	121/275	90962	ROTATOR LED P V12/24DC AMB	WORKPLUS	192
90556	BASE POLE 1/2 NPT-F ADAPTER	MLINE / ESCAPE	121/275	90963	ROTATOR LED M V12/24DC AMB	WORKPLUS	192
90557	MLINE STAINLESS HD GRID SIZE 0	MLINE	122	90964	ROTATOR LED MV V12/24DC AMB	WORKPLUS	192
90561	SIR-E LED MAX BLUE	MLINE	109	90965	ROTATOR LED FLX V12/24DC AMB	WORKPLUS	192
90562	SIR-E LED MAX AMBER	MLINE	109	90979	FWL 3.0 GREEN ALLCOLOR 12/24V ACDC	ELECTRA	82
90563	SIR-E LED MAX RED	MLINE	109	90980	FWL 3.0 BLU ALLCOLOR 12/24V ACDC	ELECTRA	82
90564	SIR-E LED MAX GREEN	MLINE	109	90981	FWL 3.0 AMB ALLCOLOR 12/24V ACDC	ELECTRA	82
90570	BASE LT DEEP PNP V12/24DC GY	MLINE	120	90982	FWL 3.0 RED ALLCOLOR 12/24V ACDC	ELECTRA	82
90571	BASE LT WALL PNP V12/24DC GY	MLINE	120	90983	FWL 3.0 CLEAR 12/24V ACDC	ELECTRA	82
90572	BASE LT DOUB PNP V12/24DC GY	MLINE	121	90984	FWL 3.0 BLU ALLCLEAR 12/24V ACDC	ELECTRA	82
90573	BASE LT DEEP PNP V12/24DC BK	MLINE	120	90985	FWL 3.0 AMB ALLCLEAR 12/24V ACDC	ELECTRA	82
90574	BASE LT WALL PNP V12/24DC BK	MLINE	120	90986	FWL 3.0 RED ALLCLEAR 12/24V ACDC	ELECTRA	82
90575	BASE LT DOUB PNP V12/24DC BK	MLINE	121	90987	FWL 3.0 GREEN ALLCLEAR 12/24V ACDC	ELECTRA	82
90576	BASE LT DEEP PNP V12/24DC WH	MLINE / ESCAPE	120/274	91131	P40 S BLU V12/24DAC GY	ELECTRA	78
90577	BASE LT WALL PNP V12/24DC RD	MLINE / ESCAPE	120/274	91132	P40 S AMB V12/24DAC GY	ELECTRA	78
90578	BASE LT DOUB PNP V12/24DC RD	MLINE / ESCAPE	121/275	91133	P40 S RED V12/24DAC GY	ELECTRA	78
90579	BASE LT DEEP PNP V12/24DC RD	MLINE / ESCAPE	120/274	91134	P40 S GRE V12/24DAC GY	ELECTRA	78
90580	BASE LT WALL PNP V12/24DC WH	MLINE / ESCAPE	120/274	91135	P40 S YEL V12/24DAC GY	ELECTRA	78
90581	BASE LT DOUB PNP V12/24DC WH	MLINE / ESCAPE	121/275	91136	P40 S CLR V12/24DAC GY	ELECTRA	78
90610	BASE LT POLE V12/24DAC GY	MLINE	121	91141	P40 S BLU V12/24DAC BK	ELECTRA	78
90611	BASE MT POLE V40/80DAC GY	MLINE	121	91142	P40 S AMB V12/24DAC BK	ELECTRA	78
90612	BASE HT POLE V120/240AC GY	MLINE	121	91143	P40 S RED V12/24DAC BK	ELECTRA	78
90613	BASE LT POLE V12/24DAC BK	MLINE	121	91144	P40 S GRE V12/24DAC BK	ELECTRA	78
90614	BASE MT POLE V40/80DAC BK	MLINE	121	91145	P40 S YEL V12/24DAC BK	ELECTRA	78
90615	BASE HT POLE V120/240AC BK	MLINE	121	91146	P40 S CLR V12/24DAC BK	ELECTRA	78
90616	BASE LT POLE V12/24DAC WH	MLINE / ESCAPE	121/275	91151	P40 S BLU V48/240AC GY	ELECTRA	78
90617	BASE MT POLE V40/80DAC WH	MLINE	121	91152	P40 S AMB V48/240AC GY	ELECTRA	78
90618	BASE HT POLE V120/240AC WH	MLINE	121	91153	P40 S RED V48/240AC GY	ELECTRA	78
90619	BASE LT POLE V12/24DAC RD	MLINE / ESCAPE	121/275	91154	P40 S GRE V48/240AC GY	ELECTRA	78
90620	BASE MT POLE V40/80DAC RD	MLINE	121	91155	P40 S YEL V48/240AC GY	ELECTRA	78
90621	BASE HT POLE V120/240AC RD	MLINE	121	91156	P40 S CLR V48/240AC GY	ELECTRA	78
90622	BASE LT POLE PNP V12/24DC GY	MLINE	121	91161	P40 S BLU V48/240AC BK	ELECTRA	78
90624	BASE LT POLE PNP V12/24DC BK	MLINE	121	91162	P40 S AMB V48/240AC BK	ELECTRA	78
90626	BASE LT POLE PNP V12/24DC WH	MLINE / ESCAPE	121/275	91163	P40 S RED V48/240AC BK	ELECTRA	78

Code	Description	Section	Page	Code	Description	Section	Page
91164	P40 S GRE V48/240AC BK	ELECTRA	78	91235	P40 JUNIOR YEL V12/24DAC BK	ELECTRA	78
91165	P40 S YEL V48/240AC BK	ELECTRA	78	91236	P40 JUNIOR CLR V12/24DAC BK	ELECTRA	78
91166	P40 S CLR V48/240AC BK	ELECTRA	78	91241	P40 JUNIOR BLU V90/240AC GY	ELECTRA	78
91167	P40 RGA STEADY V12/24DAC GY	ELECTRA	81	91242	P40 JUNIOR AMB V90/240AC GY	ELECTRA	78
91168	P40 RGA FLASH V12/24DAC GY	ELECTRA	81	91243	P40 JUNIOR RED V90/240AC GY	ELECTRA	78
91169	P40 RGA STEADY V12/24DAC BK	ELECTRA	81	91244	P40 JUNIOR GRE V90/240AC GY	ELECTRA	78
91170	P40 RGA FLASH V12/24DAC BK	ELECTRA	81	91245	P40 JUNIOR YEL V90/240AC GY	ELECTRA	78
91171	P40 RGA STEADY V48/240AC GY	ELECTRA	81	91246	P40 JUNIOR CLR V90/240AC GY	ELECTRA	78
91172	P40 RGA FLASH V48/240AC GY	ELECTRA	81	91251	P40 JUNIOR BLU V90/240AC BK	ELECTRA	78
91173	P40 RGA STEADY V48/240AC BK	ELECTRA	81	91252	P40 JUNIOR AMB V90/240AC BK	ELECTRA	78
91174	P40 RGA FLASH V48/240AC BK	ELECTRA	81	91253	P40 JUNIOR RED V90/240AC BK	ELECTRA	78
91177	P40 A V12/24DAC GY	ELECTRA	69	91254	P40 JUNIOR GRE V90/240AC BK	ELECTRA	78
91178	P40 A V12/24DAC BK	ELECTRA	69	91255	P40 JUNIOR YEL V90/240AC BK	ELECTRA	78
91179	P40 A V48/240AC GY	ELECTRA	69	91256	P40 JUNIOR CLR V90/240AC BK	ELECTRA	78
91180	P40 A V48/240AC BK	ELECTRA	69	91321	P50 S M12 BLU V12/24DAC	ELECTRA	77
91181	P40 A LED BLU V12/24DAC GY	ELECTRA	71	91322	P50 S M12 AMB V12/24DAC	ELECTRA	77
91182	P40 A LED AMB V12/24DAC GY	ELECTRA	71	91323	P50 S M12 RED V12/24DAC	ELECTRA	77
91183	P40 A LED RED V12/24DAC GY	ELECTRA	71	91324	P50 S M12 GRE V12/24DAC	ELECTRA	77
91184	P40 A LED GRE V12/24DAC GY	ELECTRA	71	91326	P50 S M12 WHI V12/24DAC	ELECTRA	77
91185	P40 A LED YEL V12/24DAC GY	ELECTRA	71	91327	P50 A M12 V12/24DAC GY	ELECTRA	68
91186	P40 A LED CLR V12/24DAC GY	ELECTRA	71	91328	P50 A M12 V12/24DAC BK	ELECTRA	68
91191	P40 A LED BLU V12/24DAC BK	ELECTRA	71	91337	P50 RGB M12 V12/24DAC	ELECTRA	79
91192	P40 A LED AMB V12/24DAC BK	ELECTRA	71	91341	P50 A LED M12 BLUV12/24DAC	ELECTRA	70
91193	P40 A LED RED V12/24DAC BK	ELECTRA	71	91342	P50 A LED M12 AMBV12/24DAC	ELECTRA	70
91194	P40 A LED GRE V12/24DAC BK	ELECTRA	71	91343	P50 A LED M12 REDV12/24DAC	ELECTRA	70
91195	P40 A LED YEL V12/24DAC BK	ELECTRA	71	91344	P50 A LED M12 GREV12/24DAC	ELECTRA	70
91196	P40 A LED CLR V12/24DAC BK	ELECTRA	71	91346	P50 A LED M12 WHIV12/24DAC	ELECTRA	70
91201	P40 A LED BLU V48/240AC GY	ELECTRA	71	91361	P50 S QC BLU V12/24DAC	ELECTRA	77
91202	P40 A LED AMB V48/240AC GY	ELECTRA	71	91362	P50 S QC AMB V12/24DAC	ELECTRA	77
91203	P40 A LED RED V48/240AC GY	ELECTRA	71	91363	P50 S QC RED V12/24DAC	ELECTRA	77
91204	P40 A LED GRE V48/240AC GY	ELECTRA	71	91364	P50 S QC GRE V12/24DAC	ELECTRA	77
91205	P40 A LED YEL V48/240AC GY	ELECTRA	71	91366	P50 S QC WHI V12/24DAC	ELECTRA	77
91206	P40 A LED CLR V48/240AC GY	ELECTRA	71	91367	P50 A QC V12/24DAC GY	ELECTRA	68
91207	P40 A JUNIOR V12/24DAC BK	ELECTRA	69	91368	P50 A QC V12/24DAC BK	ELECTRA	68
91208	P40 A JUNIOR V12/24DAC GY	ELECTRA	69	91378	P50 RGB QC V12/24DAC	ELECTRA	79
91209	P40 A JUNIOR V90/240AC BK	ELECTRA	69	91381	P50 A LED QC BLU V12/24DAC	ELECTRA	70
91210	P40 A JUNIOR V90/240AC GY	ELECTRA	69	91382	P50 A LED QC AMB V12/24DAC	ELECTRA	70
91211	P40 A LED BLU V48/240AC BK	ELECTRA	71	91383	P50 A LED QC RED V12/24DAC	ELECTRA	70
91212	P40 A LED AMB V48/240AC BK	ELECTRA	71	91384	P50 A LED QC GRE V12/24DAC	ELECTRA	70
91213	P40 A LED RED V48/240AC BK	ELECTRA	71	91386	P50 A LED QC WHI V12/24DAC	ELECTRA	70
91214	P40 A LED GRE V48/240AC BK	ELECTRA	71	91427	P50 RGA V24 DAC	ELECTRA	80
91215	P40 A LED YEL V48/240AC BK	ELECTRA	71	91447	P50 RGA V12 DAC	ELECTRA	80
91216	P40 A LED CLR V48/240AC BK	ELECTRA	71	91661	MLAMP X A AMB V12/24DAC GY	ELECTRA	36
91221	P40 JUNIOR BLU V12/24DAC GY	ELECTRA	78	91662	MLAMP X A RED V12/24DAC GY	ELECTRA	36
91222	P40 JUNIOR AMB V12/24DAC GY	ELECTRA	78	91663	MLAMP X A GRE V12/24DAC GY	ELECTRA	36
91223	P40 JUNIOR RED V12/24DAC GY	ELECTRA	78	91664	MLAMP X A YEL V12/24DAC GY	ELECTRA	36
91224	P40 JUNIOR GRE V12/24DAC GY	ELECTRA	78	91673	MLAMP X A AMB V110AC GY	ELECTRA	36
91225	P40 JUNIOR YEL V12/24DAC GY	ELECTRA	78	91674	MLAMP X A RED V110AC GY	ELECTRA	36
91226	P40 JUNIOR CLR V12/24DAC GY	ELECTRA	78	91675	MLAMP X A GRE V110AC GY	ELECTRA	36
91231	P40 JUNIOR BLU V12/24DAC BK	ELECTRA	78	91676	MLAMP X A YEL V110AC GY	ELECTRA	36
91232	P40 JUNIOR AMB V12/24DAC BK	ELECTRA	78	91679	MLAMP X A AMB V240AC GY	ELECTRA	36
91233	P40 JUNIOR RED V12/24DAC BK	ELECTRA	78	91680	MLAMP X A RED V240AC GY	ELECTRA	36
91234	P40 JUNIOR GRE V12/24DAC BK	ELECTRA	78	91681	MLAMP X A GRE V240AC GY	ELECTRA	36

Code	Description	Section	Page	Code	Description	Section	Page
91682	MLAMP X A YEL V240AC GY	ELECTRA	36	96043	EX 080 RA H RED V24DC	EXPRO	226
95001	EX 070 SLR S BLU V12/24DAC	EXPRO	224	96044	EX 080 RA H GRE V24DC	EXPRO	226
95002	EX 070 SLR S AMB V12/24DAC	EXPRO / ESCAPE	224/279	96045	EX 080 RA H YEL V24DC	EXPRO	226
95003	EX 070 SLR S RED V12/24DAC	EXPRO / ESCAPE	224/279	96051	EX 080 RA H BLU V24AC	EXPRO	226
95004	EX 070 SLR S GRE V12/24DAC	EXPRO	224	96052	EX 080 RA H AMB V24AC	EXPRO	226
95006	EX 070 SLR S CLR V12/24DAC	EXPRO	224	96053	EX 080 RA H RED V24AC	EXPRO	226
95011	EX 070 SLR S BLU V120/240AC	EXPRO	224	96054	EX 080 RA HGRE V24AC	EXPRO	226
95012	EX 070 SLR S AMB V120/240AC	EXPRO / ESCAPE	224/279	96055	EX 080 RA H YEL V24AC	EXPRO	226
95013	EX 070 SLR S RED V120/240AC	EXPRO / ESCAPE	224/279	96061	EX 080 LA L BLU V12DC	EXPRO	227
95014	EX 070 SLR S GRE V120/240AC	EXPRO	224	96062	EX 080 LA L AMB V12DC	EXPRO	227
95016	EX 070 SLR S CLR V120/240AC	EXPRO	224	96063	EX 080 LA L RED V12DC	EXPRO	227
95941	EX 080 RA BLU V12DC	EXPRO	226	96064	EX 080 LA L GRE V12DC	EXPRO	227
95942	EX 080 RA AMB V12DC	EXPRO	226	96065	EX 080 LA L YEL V12DC	EXPRO	227
95943	EX 080 RA RED V12DC	EXPRO	226	96071	EX 080 LA L BLU V24DC	EXPRO	227
95944	EX 080 RA GRE V12DC	EXPRO	226	96072	EX 080 LA L AMB V24DC	EXPRO	227
95945	EX 080 RA YEL V12DC	EXPRO	226	96073	EX 080 LA L RED V24DC	EXPRO	227
95951	EX 080 RA BLU V12AC	EXPRO	226	96074	EX 080 LA L GRE V24DC	EXPRO	227
95952	EX 080 RA AMB V12AC	EXPRO	226	96075	EX 080 LA L YEL V24DC	EXPRO	227
95953	EX 080 RA RED V12AC	EXPRO	226	96081	EX 080 LA L BLU V24AC	EXPRO	227
95954	EX 080 RA GRE V12AC	EXPRO	226	96082	EX 080 LA L AMB V24AC	EXPRO	227
95955	EX 080 RA YEL V12AC	EXPRO	226	96083	EX 080 LA L RED V24AC	EXPRO	227
95961	EX 080 RA BLU V24DC	EXPRO	226	96084	EX 080 LA L GRE V24AC	EXPRO	227
95962	EX 080 RA AMB V24DC	EXPRO	226	96085	EX 080 LA L YEL V24AC	EXPRO	227
95963	EX 080 RA RED V24DC	EXPRO	226	96091	EX 080 LA L BLU V48DC	EXPRO	227
95964	EX 080 RA GRE V24DC	EXPRO	226	96092	EX 080 LA L AMB V48DC	EXPRO	227
95965	EX 080 RA YEL V24DC	EXPRO	226	96093	EX 080 LA L RED V48DC	EXPRO	227
95971	EX 080 RA BLU V24AC	EXPRO	226	96094	EX 080 LA L GRE V48DC	EXPRO	227
95972	EX 080 RA AMB V24AC	EXPRO	226	96095	EX 080 LA L YEL V48DC	EXPRO	227
95973	EX 080 RA RED V24AC	EXPRO	226	96101	EX 080 LA L BLU V48AC	EXPRO	227
95974	EX 080 RA GRE V24AC	EXPRO	226	96102	EX 080 LA L AMB V48AC	EXPRO	227
95975	EX 080 RAYEL V24AC	EXPRO	226	96103	EX 080 LA L RED V48AC	EXPRO	227
96001	EX 080 RA BLU V110AC	EXPRO	226	96104	EX 080 LA L GRE V48AC	EXPRO	227
96002	EX 080 RA AMB V110AC	EXPRO	226	96105	EX 080 LA L YEL V48AC	EXPRO	227
96003	EX 080 RA RED V110AC	EXPRO	226	96111	EX 080 LA L BLU V110AC	EXPRO	227
96004	EX 080 RA GRE V110AC	EXPRO	226	96112	EX 080 LA L AMB V110AC	EXPRO	227
96005	EX 080 RA YEL V110AC	EXPRO	226	96113	EX 080 LA L RED V110AC	EXPRO	227
96011	EX 080 RA BLU V240AC	EXPRO	226	96114	EX 080 LA L GRE V110AC	EXPRO	227
96012	EX 080 RA AMB V240AC	EXPRO	226	96115	EX 080 LA L YEL V110AC	EXPRO	227
96013	EX 080 RA RED V240AC	EXPRO	226	96121	EX 080 LA L BLU V240AC	EXPRO	227
96014	EX 080 RA GRE V240AC	EXPRO	226	96122	EX 080 LA L AMB V240AC	EXPRO	227
96015	EX 080 RA YEL V240AC	EXPRO	226	96123	EX 080 LA L RED V240AC	EXPRO	227
96021	EX 080 RA H BLU V12DC	EXPRO	226	96124	EX 080 LA L GRE V240AC	EXPRO	227
96022	EX 080 RA H AMB V12DC	EXPRO	226	96125	EX 080 LA L YEL V240AC	EXPRO	227
96023	EX 080 RA H RED V12DC	EXPRO	226	96131	EX 080 LA L H BLU V12DC	EXPRO	227
96024	EX 080 RA H GRE V12DC	EXPRO	226	96132	EX 080 LA L H AMB V12DC	EXPRO	227
96025	EX 080 RA H YEL V12DC	EXPRO	226	96133	EX 080 LA L H RED V12DC	EXPRO	227
96031	EX 080 RA H BLU V12AC	EXPRO	226	96134	EX 080 LA L H GRE V12DC	EXPRO	227
96032	EX 080 RA H AMB V12AC	EXPRO	226	96135	EX 080 LA L H YEL V12DC	EXPRO	227
96033	EX 080 RA H RED V12AC	EXPRO	226	96141	EX 080 LA L H BLU V12AC	EXPRO	227
96034	EX 080 RA H GRE V12AC	EXPRO	226	96142	EX 080 LA L H AMB V12AC	EXPRO	227
96035	EX 080 RA H YEL V12AC	EXPRO	226	96143	EX 080 LA L H RED V12AC	EXPRO	227
96041	EX 080 RA H BLU V24DC	EXPRO	226	96144	EX 080 LA L H GRE V12AC	EXPRO	227
96042	EX 080 RA H AMB V24DC	EXPRO	226	96145	EX 080 LA L H YEL V12AC	EXPRO	227

Code	Description	Section	Page	Code	Description	Section	Page
96151	EX 080 LA L H BLU V24DC	EXPRO	227	97065	EX 045 LD PAG SP YEL V24DAC	EXPRO	228
96152	EX 080 LA L H AMB V24DC	EXPRO	227	97066	EX 045 LD PAG SP CLR V24DAC	EXPRO	228
96153	EX 080 LA L H RED V24DC	EXPRO	227	97071	EX 045 LD PAG SP BLU V48DAC	EXPRO	228
96154	EX 080 LA L H GRE V24DC	EXPRO	227	97072	EX 045 LD PAG SP AMB V48DAC	EXPRO	228
96155	EX 080 LA L H YEL V24DC	EXPRO	227	97073	EX 045 LD PAG SP RED V48DAC	EXPRO	228
96161	EX 080 LA L H BLU V24AC	EXPRO	227	97074	EX 045 LD PAG SP GRE V48DAC	EXPRO	228
96162	EX 080 LA L H AMB V24AC	EXPRO	227	97075	EX 045 LD PAG SP YEL V48DAC	EXPRO	228
96163	EX 080 LA L H RED V24AC	EXPRO	227	97076	EX 045 LD PAG SP CLR V48DAC	EXPRO	228
96164	EX 080 LA L H GRE V24AC	EXPRO	227	97081	EX 045 LD PAG SP BLU V110AC	EXPRO	228
96165	EX 080 LA L H YEL V24AC	EXPRO	227	97082	EX 045 LD PAG SP AMB V110AC	EXPRO	228
96171	EX 080 LA F BLU V12DAC	EXPRO	227	97083	EX 045 LD PAG SP RED V110AC	EXPRO	228
96172	EX 080 LA F AMB V12DAC	EXPRO	227	97084	EX 045 LD PAG SP GRE V110AC	EXPRO	228
96173	EX 080 LA F RED V12DAC	EXPRO	227	97085	EX 045 LD PAG SP YEL V110AC	EXPRO	228
96174	EX 080 LA F GRE V12DAC	EXPRO	227	97086	EX 045 LD PAG SP CLR V110AC	EXPRO	228
96175	EX 080 LA F YEL V12DAC	EXPRO	227	97091	EX 045 LD PAG SP BLU V240AC	EXPRO	228
96181	EX 080 LA F BLU V24DAC	EXPRO	227	97092	EX 045 LD PAG SP AMB V240AC	EXPRO	228
96182	EX 080 LA F AMB V24DAC	EXPRO	227	97093	EX 045 LD PAG SP RED V240AC	EXPRO	228
96183	EX 080 LA F RED V24DAC	EXPRO	227	97094	EX 045 LD PAG SP GRE V240AC	EXPRO	228
96184	EX 080 LA F GRE V24DAC	EXPRO	227	97095	EX 045 LD PAG SP YEL V240AC	EXPRO	228
96185	EX 080 LA F YEL V24DAC	EXPRO	227	97096	EX 045 LD PAG SP CLR V240AC	EXPRO	228
96191	EX 080 LA F BLU V48DAC	EXPRO	227	97191	EX 050 OVO M SMD BLU V12/24DAC	EXPRO	222
96192	EX 080 LA F AMB V48DAC	EXPRO	227	97192	EX 050 OVO M SMD AMB V12/24DAC	EXPRO	222
96193	EX 080 LA F RED V48DAC	EXPRO	227	97193	EX 050 OVO M SMD RED V12/24DAC	EXPRO	222
96194	EX 080 LA F GRE V48DAC	EXPRO	227	97194	EX 050 OVO M SMD GRE V12/24DAC	EXPRO	222
96195	EX 080 LA F YEL V48DAC	EXPRO	227	97195	EX 050 OVO M SMD YEL V12/24DAC	EXPRO	222
96201	EX 080 LA F BLU V110DAC	EXPRO	227	97196	EX 050 OVO M SMD CLR V12/24DAC	EXPRO	222
96202	EX 080 LA F AMB V110DAC	EXPRO	227	97201	EX 050 OVO M SMD BLU V90/240AC	EXPRO	222
96203	EX 080 LA F RED V110DAC	EXPRO	227	97202	EX 050 OVO M SMD AMB V90/240AC	EXPRO	222
96204	EX 080 LA F GRE V110DAC	EXPRO	227	97203	EX 050 OVO M SMD RED V90/240AC	EXPRO	222
96205	EX 080 LA F YEL V110DAC	EXPRO	227	97204	EX 050 OVO M SMD GRE V90/240AC	EXPRO	222
96211	EX 080 LA F BLU V240DAC	EXPRO	227	97205	EX 050 OVO M SMD YEL V90/240AC	EXPRO	222
96212	EX 080 LA F AMB V240DAC	EXPRO	227	97206	EX 050 OVO M SMD CLR V90/240AC	EXPRO	222
96213	EX 080 LA F RED V240DAC	EXPRO	227	97211	EX 070 FLR S BLU V12/24DAC	EXPRO	223
96214	EX 080 LA F GRE V240DAC	EXPRO	227	97212	EX 070 FLR S AMB V12/24DAC	EXPRO / ESCAPE	223/279
96215	EX 080 LA F YEL V240DAC	EXPRO	227	97213	EX 070 FLR S RED V12/24DAC	EXPRO / ESCAPE	223/279
96552	EX 0100 STF 15J AMB V12/24DC	EXPRO	225	97214	EX 070 FLR S GRE V12/24DAC	EXPRO	223
96553	EX 0100 STF 15J RED V12/24DC	EXPRO	225	97216	EX 070 FLR S CLR V12/24DAC	EXPRO	223
96556	EX 0100 STF 15J CLR V12/24DC	EXPRO	225	97221	EX 070 FLR S BLU V120/240AC	EXPRO	223
96572	EX 0100 STF 15J AMB V240AC	EXPRO	225	97222	EX 070 FLR S AMB V120/240AC	EXPRO / ESCAPE	223/279
96573	EX 0100 STF 15J RED V240AC	EXPRO	225	97223	EX 070 FLR S RED V120/240AC	EXPRO / ESCAPE	223/279
96576	EX 0100 STF 15J CLR V240AC	EXPRO	225	97224	EX 070 FLR S GRE V120/240AC	EXPRO	223
96699	EX 025 PAG	EXPRO / ESCAPE	228/262	97226	EX 070 FLR S CLR V120/240AC	EXPRO	223
96700	EX 035 PAG PCS	ESCAPE	262	97230	EX 070 FLR S RED ALLCLEAR V12/24DAC	EXPRO / ESCAPE	223/279
97051	EX 045 LD PAG SP BLU V12DAC	EXPRO	228	97241	EX 070 FLR S BLU V40/80DAC	EXPRO	223
97052	EX 045 LD PAG SP AMB V12DAC	EXPRO	228	97242	EX 070 FLR S AMB V40/80DAC	EXPRO / ESCAPE	223/279
97053	EX 045 LD PAG SP RED V12DAC	EXPRO	228	97243	EX 070 FLR S RED V40/80DAC	EXPRO / ESCAPE	223/279
97054	EX 045 LD PAG SP GRE V12DAC	EXPRO	228	97244	EX 070 FLR S GRE V40/80DAC	EXPRO	223
97055	EX 045 LD PAG SP YEL V12DAC	EXPRO	228	97246	EX 070 FLR S CLR V40/80DAC	EXPRO	223
97056	EX 045 LD PAG SP CLR V12DAC	EXPRO	228	97251	EX 070 SLR S BLU V40/80DAC	EXPRO	224
97061	EX 045 LD PAG SP BLU V24DAC	EXPRO	228	97252	EX 070 SLR S AMB V40/80DAC	EXPRO / ESCAPE	224/279
97062	EX 045 LD PAG SP AMB V24DAC	EXPRO	228	97253	EX 070 SLR S RED V40/80DAC	EXPRO / ESCAPE	224/279
97063	EX 045 LD PAG SP RED V24DAC	EXPRO	228	97254	EX 070 SLR S GRE V40/80DAC	EXPRO	224
97064	EX 045 LD PAG SP GRE V24DAC	EXPRO	228	97256	EX 070 SLR S CLR V40/80DAC	EXPRO	224

#morethanbrightideas

sirena.it

facebook.com/sirenaspa

twitter.com/sirenaspa

plus.google.com/+sirenaspa

linkedin.com/company/sirena-spa

youtube.com/sirenait



SIRENA

Sirena SpA
C.so Moncenisio, 5
10090 Rosta (TO)
Italy

T +39 011 95 68 555
F +39 011 95 67 928
www.sirena.it
info@sirena.it

Sirena SpA can modify this catalogue at any time without prior notice. No parts of this catalogue, including text, images and logos, may be reproduced, partially reproduced or forwarded via electronic means without prior written authorization of Sirena SpA. All data reproduced in this catalogue have been edited and checked with the best possible accuracy, however Sirena SpA does not accept any liability for errors and omissions in drawings, descriptions or technical data in this catalogue.



8 010152 010996

GENERALE
V 1.0
11.2017
Printed in Italy